

MOTORTECH Pickup

Technical Data/Installation Instructions
for Hall Effect Pickup
P/N 66.60.043-60 / P/N 66.60.043-100



01.12.044-2023-A-EN | Rev. 11/2023 (A)

MOTORTECH GmbH
Hunaeusstrasse 5
29227 Celle, Germany

Tel. +49 51 41 93 99 0
Fax +49 51 41 93 99 98

www.motortech.de
motortech@motortech.de

MOTORTECH Americas, LLC
1400 Dealers Avenue, Suite A
New Orleans, LA 70123, USA

Tel. +1 504 355 4212
Fax +1 504 355 4217

www.motortechamericas.com
info@motortechamericas.com

MOTORTECH Shanghai Co. Ltd.
Room 1018 Enterprise Square,
No. 228 Meiyuan Road, Jing'An District,
200070 Shanghai, China

Tel. +86 21 6380 7338

www.motortechshanghai.com
info@motortechshanghai.com

Technical Data

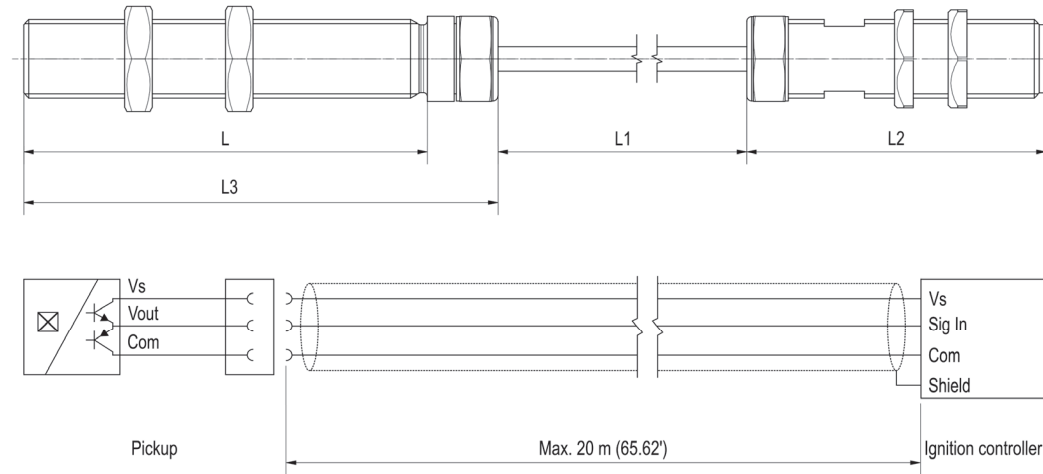

Hall Effect Pickup

Mechanical Data

Feature	P/N	Value
L	-60	60 mm (2,36")
	-100	100 mm (3,94")
L1	-60	205 mm to 225 mm (8,07" to 8,86")
	-100	320 mm to 340 mm (12,6" to 13,39")
L2		44,5 mm (1,75")
L3	-60	70,5 mm (2,78")
	-100	110,5 mm (4,35")
Thread/Screw connection		M12x1
Temperature		-25 °C to +125 °C (-13 °F to +257 °F)
Air gap		0,25 mm to 3 mm (0,01" to 0,12")
Protection class		IP67, IP69
Enclosure material		Stainless steel
Hexagon nut		Wrench opening 13

Electrical Data

Feature	Value
Pole connector	M12x1, 4-polig, male
Supply voltage	Nominal voltage: 24 V DC Operating voltage: 8 V DC to 32 V DC
Max. power consumption without load	15 mA
Max. output current	±40 mA
Operating frequency	0 kHz to 10 kHz
Triggering	Blind holes, through holes, screws, pins, metal inserts, slots
Signal output	Push pull
Signal assignment at output	High level: metal Low level: no metal

Connector

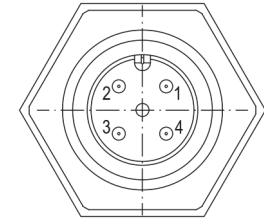

Pin	Assignment
1	Vs
2	Unused
3	Common
4	Vout

Certification

The Hall effect pickup is certified as follows: CE

The EU Declaration of Conformity can be obtained on request from your MOTORTECH contact person.

Proper Disposal

For the proper disposal of MOTORTECH equipment, observe the information provided at www.motortech.de.

Intended Use

When installed correctly on stationary gas engines in the industrial sector, the Hall effect pickup is suitable for position detection of the camshaft or crankshaft. The signals can be used for determining the ignition timing with an ignition controller. Any use other than the one described in the installation instruction shall be considered improper use and will result in the voiding of all warranties.

Safety Instructions



Explosion hazard!

The pickup may only be used in a non-explosive atmosphere. There is a risk of sparking.



Risk of destruction!

The pickup can be destroyed or damaged by the following hazards:

- Mechanical hazards
The pickup does not have to be exposed to ANY mechanical hazard. Please note that deviations from the recommended installation distance can be necessary due to different engines and installation conditions.
- UV radiation
The pickup and the connection leads have to be protected against UV radiation. This can be achieved when the sensor is used in internal areas.
- Electrostatic charging
Electrostatic charging of the metal enclosure components has to be avoided. To avoid dangerous electrostatic charging of the metal enclosure components, incorporate these in the potential equalization.

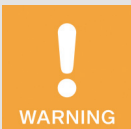

Risk of injury and destruction!

Observe the following safety instructions during the installation of the pickup:

- Start the installation only if the engine is shut down.
- All work has to be performed by trained and authorized personnel.
- Follow all safety instructions of the system and engine manufacturers, especially in high voltage areas.
- High temperatures can occur at the installation location of the pickup. Do not touch the pickup.

Triggering

Blind holes



Through holes



Screws



Pins



Metal inserts



Slots



*Observe Distance to Triggering!

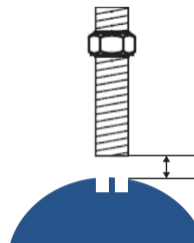
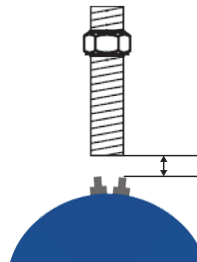

Installation Instructions

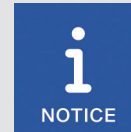

Power supply only after installation

The pickup must not be connected to the power supply until it has been installed in its final position on the engine. For more information, also note the following sections.

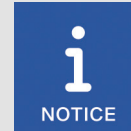

Connection to ignition controller

The pickup has to be connected to an ignition controller with a shielded and twisted lead. The ignition controller provides the power supply for the pickup. No other consumer may be connected to the power supply. Use a short lead that does not exceed a length of 20 meters (65.62'). Connect the lead shield on one side to the ignition controller. If the ignition controller does not have a corresponding connection, connect the lead shield with the earth potential.

Always carry out the start-up of the pickup in the following steps in the order given:

1. First install the pickup on the engine.
2. Set the distance of 1 mm (0.04") recommended by MOTORTECH to the triggering. (Change of distance: 1 revolution \pm 1 mm [0.04"])*
3. Fix the pickup (tightening torque: 15 Nm [11 lb-ft]).
4. Connect the pickup to the power supply.
5. Start the engine without gas supply.
 - ▶ As soon as the pickup detects the first mechanical edges of the triggering, an automatic calibration takes place. After that the pickup starts to output signals.
 - ▶ Check the ignition timing with a stroboscopic lamp.

Remedy in Case of Error

In the sequence of steps was not followed during start-up, calibration will fail and the pickup will not provide any or only unreliable signals. In this case the calibration has to be repeated.

Proceed as follows:

1. Disconnect the pickup from power supply for at least three seconds.
2. Reconnect the power supply.
 - ▶ The calibration is performed again.

Maintenance

Check regularly that the pickup is tight and make sure that it is not subject to wear. If necessary, the pickup can be cleaned with a damp cloth and a non-aggressive cleaning agent when switched off.