

ALL-IN-ONE.NT – GENERATOR & CHP CONTROL SYSTEM

FIRMWARE IS-NT-AFR 2.3.1 / 2.2

OPERATING MANUAL



ALL-IN-ONE.NT 
MOTORTECH GENERATOR & CHP CONTROL SYSTEM

Copyright

© Copyright 2016 MOTORTECH GmbH. All rights reserved.

Distribution and reproduction of this publication or parts thereof, regardless of the specific purpose and form, are not permissible without express written approval by MOTORTECH. Information contained in this publication may be changed without prior notice.

Trademarks

MOTORTECH products and the MOTORTECH logo are registered and/or common law trademarks of the MOTORTECH Holding GmbH. All further trademarks and logos displayed or used in this publication are the property of the respective entitled person.

TABLE OF CONTENTS

1 General Information	7
1.1 What Is the Purpose of this Operating Manual?	7
1.2 Who Is this Operating Manual Targeted to?	7
1.3 Which Symbols Are Used in the Operating Manual?	7
1.4 Which Abbreviations/Acronyms Are Used in the Operating Manual?	8
1.5 What Other Documentation Is Available?	11
2 Safety Instructions	13
2.1 General Safety Instructions	13
2.2 Electrostatic Discharge Hazards	13
2.3 Special Safety Instructions for the Device	14
2.4 Proper Disposal.....	15
3 Intended Use	16
3.1 Functional Description	16
3.2 Applications.....	16
4 Product Description	18
4.1 Technical Data	18
4.1.1 Certifications	18
4.1.2 Mechanical Data	20
4.1.3 Warning Notices on the Device.....	20
4.1.4 Product Identification – Labeling on the Device.....	21
4.1.5 Electrical Data.....	21
4.1.6 Interfaces	24
4.1.7 Overview Drawings.....	26
5 Installation Instructions	31
5.1 Unpacking	31
5.2 Installation	31
5.3 Wiring.....	32
6 Functions	33
6.1 Operation Modes	33
6.2 Function Enabling via Hardware Dongle	34
6.3 Measuring Inputs for Cylinder Temperatures	34
6.4 Gas Ventilation Test Before Engine Start	35
6.5 Overspeed Protection at Engine Start.....	36
6.6 Analog and Binary Mixer Control	36
6.7 Adjustable Number of Synchronization Attempts	37

TABLE OF CONTENTS

6.8	Additional Test Parameters for Mains Voltage	37
6.9	Adjustable Filter for Active Power Measured Values	37
6.10	Mixture Control	38
6.10.1	Fixed Mixer Positions	38
6.10.2	Methane Content Adjustment of the Fixed Mixer Positions	40
6.10.3	Power-Dependent Air/Fuel Mixture Control	41
6.10.4	Mixture Control Modes	42
6.11	Operation with Two Air/Gas Mixers	43
6.12	Misfire Protection	45
6.13	Detonation Control	46
6.14	Conduct with Off Load Protection	46
6.14.1	Adjustable Idle Time	46
6.14.2	Resetting the Overspeed Alarm	48
6.15	Start Blocking after Engine Stop	49
6.16	Signaling Active Mains Protections	49
6.17	Timer for Engine Shutdown	49
6.18	Alarm Notifications – Automatic Activation/Deactivation	49
6.19	Operation with MOTORTECH® Devices	50
6.20	VDE-AR-N 4105 Application Guide	51
6.21	BDEW Medium Voltage Guideline	51
7	ComAp PC Suite	52
7.1	ComAp PC Suite System Requirements	52
7.2	ComAp PC Suite Installation	53
8	Settings via GenConfig	54
8.1	Available Memory Space	56
8.2	Overview: AFR Archives	57
8.3	Setting Program Mode	59
8.4	Setting ECU List for MOTORTECH® Devices	60
8.5	Modules – DetConzo	61
8.6	Additional Logical Binary Inputs (LBI)	61
8.7	Additional Logical Binary Outputs (LBO)	62
8.8	Additional Logical Analog Inputs (LAI)	64
8.9	Setpoints – ProcessControl	65
8.10	Setpoints – Basic Settings	65
8.11	Setpoints – Comms Settings	66
8.12	Setpoints – Engine Protect	66
8.13	Setpoints – Mains Protect	67

8.14	Setpoints – Sync/Load Ctrl.....	69
8.15	Setpoints – Act. calls/SMS	69
8.16	Setpoints – AFR Control.....	70
8.17	Setpoints – I-Step	74
8.18	Setpoints – ECON4-EngRPM	75
8.19	Setpoints – ECON4-EngStart.....	76
8.20	Setpoints – ECON4-MainPID.....	76
8.21	Setpoints – DetCon20	77
8.22	Values – Statistics.....	78
8.23	Values – AFR Control	78
8.24	Values – I-Step.....	79
8.25	Values – ECON4	80
8.26	Values – DetCon20.....	80
9	Monitoring / Controlling	81
9.1	InteliMonitor	81
9.2	ALL-IN-ONE.NT Display.....	83
9.2.1	Certifications	83
9.2.2	Mechanical Data.....	85
9.2.3	Warning Notices on the Device	85
9.2.4	Product Identification – Labeling on the Device	85
9.2.5	Electrical Data	86
9.2.6	Display	86
9.2.7	Interfaces.....	86
9.2.8	Buttons and LEDs on the Device	87
9.3	ALL-IN-ONE.Vision 5.....	92
9.3.1	Certifications	92
9.3.2	Mechanical Data.....	94
9.3.3	Warning Notices on the Device	94
9.3.4	Product Identification – Labeling on the Device	94
9.3.5	Electrical Data	95
9.3.6	Display	95
9.3.7	Interfaces.....	95
9.3.8	Buttons and LEDs on the Device	96
9.4	ALL-IN-ONE.Vision 8	99
9.4.1	Certifications	99
9.4.2	Mechanical Data.....	101
9.4.3	Warning Notices on the Device	101
9.4.4	Product Identification – Labeling on the Device	101

TABLE OF CONTENTS

9.4.5 Electrical Data	102
9.4.6 Display	102
9.4.7 Interfaces	103
9.4.8 Buttons and LEDs on the Device	104
9.5 Modbus	107
10 Runtime Data via WinScope	108
11 Operation	109
11.1 Start-up	109
11.2 Firmware Update	109
12 Errors	110
12.1 Possible Faults	110
12.2 Customer Service Information	110
12.3 Returning Equipment for Repair / Inspection	110
12.4 Instructions for Packaging the Equipment	110
13 Maintenance	111
13.1 Maintenance Instructions	111
13.2 Spare Parts and Accessories	112
14 Index	113

1 GENERAL INFORMATION

Read through this operating manual carefully before use and become familiar with the product. Installation and start-up should not be carried out before reading and understanding this document. Keep this manual readily available so that you can reference it as needed.

1.1 What Is the Purpose of this Operating Manual?

This manual serves as an aid for the installation and operation of the product and supports the technical staff with all operating and maintenance tasks to be performed. Furthermore, this manual is aimed at preventing dangers to life and health of the user and third parties.

1.2 Who Is this Operating Manual Targeted to?

The operating manual provides a code of conduct for personnel tasked with the construction of control cabinets for gas engine gen-sets as well as the setup, operation, maintenance, and repair of gas engine gen-sets. A certain level of technical knowledge with respect to the operation of gas engine gen-sets and basic knowledge of electronic ignition systems are necessary. Persons who are only authorized to operate the gas engine gen-set shall be trained by the operating company and shall be expressly instructed concerning potential hazards.

1.3 Which Symbols Are Used in the Operating Manual?

The following symbols are used in this manual and must be observed:



Example

This symbol indicates examples, which point out necessary handling steps and techniques. In addition, you receive additional information from the examples, which will increase your knowledge.



Notice

This symbol indicates important notices for the user. Follow these. In addition, this symbol is used for overviews that give you a summary of the necessary work steps.



Warning

This symbol indicates warnings for possible risks of property damage or risks to health. Read these warning notices carefully and take the mentioned precautionary measures.

1 GENERAL INFORMATION



Danger

This symbol indicates warnings for danger to life, especially due to high voltage. Read these warning notices carefully and take the mentioned precautionary measures.

1.4 Which Abbreviations/Acronyms Are Used in the Operating Manual?

In the manual or the user interface, the following abbreviations / acronyms are used.

Abb.	Term	Description	Explanation
AFR	Air/Fuel Ratio	Air/fuel ratio	Combustion air ratio
AI	Analog Input	Analog input	
AIO	ALL-IN-ONE		Product name
AMF	Auto Mains Failure		Function of the ALL-IN-ONE.NT which the gen-set automatically starts in the event of a mains failure.
AO	Analog Output	Analog output	
AVR	Automatic Voltage Regulator	Automatic voltage regulator	
BDEW	Bundesverband der Energie- und Wasserwirtschaft	Federal Association of the Energy and Water Industry	German association of companies in the energy and water industry
BI	Binary Input	Binary input	
BO	Binary Output	Binary output	
CAN bus	Controller Area Network Bus	Bus for control devices / networks	Asynchronous serial connection system for linking control units
CE	Conformité Européenne	Conformity with EU directives	Mark based on EU legislation for certain products in conjunction with product safety
CH ₄	Methane	Abbreviation for methane derived from the chemical empirical formula CH ₄	Natural combustible gas, which forms the main constituent of natural gas.
DC	Direct Current	Direct current	

Abb.	Term	Description	Explanation
ECU	Electronic Control Unit	Electronic control unit	Electronic module for control and regulation
EMC	Electromagnetic Compatibility		Compatibility of electrical or electronic equipment items with their surroundings
ESL	Engine Specific List		File type
FSTN	Film Super Twisted Nematic		Display technology
GCB	Generator Circuit Breaker	Generator circuit breaker	
LAI	Logical Analog Input	Logical analog input	Logical input of ALL-IN-ONE.NT for an analog signal
LBI	Logical Binary Input	Logical binary input	Logical input of ALL-IN-ONE.NT for a binary signal
LBO	Logical Binary Output	Logical binary output	Logical output of ALL-IN-ONE.NT for a binary signal
LED	Light Emitting Diode	Light emitting diode	Light emitting electronic semiconductor
MAP	Manifold Absolute Pressure	Absolute manifold pressure	
MAT	Manifold Air Temperature	Manifold air temperature	
MCB	Mains Circuit Breaker	Mains circuit breaker	
MIC	MOTORTECH Ignition Controller	MOTORTECH ignition controller	
MINT	Multiple application with internal control loops	Multiple application with internal control loops	Application type of ALL-IN-ONE.NT
NEMA	National Electrical Manufacturers Association		Organization which sets standards in the electrical engineering industry.
PID	Proportional Integral Derivative	Proportional, integral, derivative	
PLC	Programmable Logic Controller	Programmable logic controller	Device for controlling or regulating that is programmed digitally.

1 GENERAL INFORMATION

Abb.	Term	Description	Explanation
PtM	Parallel to mains	Parallel operation	
PWM	Pulse Width Modulation	Pulse width modulation	
RPM	Revolutions Per Minute	Revolutions per minute	Unit for speed
RTU	Remote Terminal Unit	Remote terminal unit	
SCADA	Supervisory Control And Data Acquisition		Monitoring, control and data collection of technical processes using a computer system
SMS	Short Message Service	Short message service	Telecommunications service for transmitting text messages
SPI	Single Parallel Island	Independent parallel island operation of a gen-set	Application type of ALL-IN-ONE.NT
SPtM	Single Parallel to Mains	Independent mains parallel operation of a gen-set	Application type of ALL-IN-ONE.NT
STP	Shielded Twisted Pair	Pair of twisted cables	
TFT	Thin-Film Transistor	Thin-film transistor	Control technology for liquid crystal flat screens
UEGO	Universal Exhaust Gas Oxygen	Broadband lambda	
USB	Universal Serial Bus		Serial connection system to link a computer to external devices
VDE	Verband der Elektrotechnik Elektronik Informationstechnik	Association for Electrical, Electronic & Information Technology	Association for industries and trades in electrical and information technology
VPIO	Virtual Periphery I/O	Virtual periphery inputs/outputs	

1.5 What Other Documentation Is Available?

The following documentation is available as a supplement for your generator & CHP control system and is included on the supplied storage device (USB flash drive or CD-ROM). The ALL-IN-ONE.NT generator & CHP control system corresponds to the generator & CHP control system IS-NT-BB.

Document	Description
IGS-NT-SPTM-3.0 Reference Guide*	General description of the SPtM applications for the IntelliGen ^{NT} and IntelliSys ^{NT} generator & CHP control systems. Contains the description of the engine and generator control, the power control in parallel operation and a list of all parameters and values as well as logical binary inputs and outputs.
IGS-NT-SPI-3.0 Reference Guide*	General description of the SPI applications for IntelliGen ^{NT} and IntelliSys ^{NT} generator & CHP control systems. Contains the description of the engine and generator control, the power control in parallel operation and a list of all parameters and values as well as logical binary inputs and outputs.
IGS-NT-MINT-3.0 Reference Guide*	General description of the MINT applications for IntelliGen ^{NT} and IntelliSys ^{NT} generator & CHP control systems. Contains the description of the engine and generator control, power control and a list of all parameters and values as well as logical binary inputs and outputs.
IGS-NT-Combi-3.0 Reference Guide*	General description of the Combi applications for IntelliGen ^{NT} and IntelliSys ^{NT} generator & CHP control systems. Contains the description of the engine and generator control in the SPI, SPtM and MINT applications, the power control and a list of all parameters and values as well as logical binary inputs and outputs.
IGS-NT-3.0 Application Guide	Applications for the IntelliGen ^{NT} , IntelliSys ^{NT} and IntelliMains ^{NT} generator & CHP control systems, wiring examples, description of the PLC functions as well as the virtual and common peripheral devices
IGS-NT-3.0 Operator Guide	Operating instructions for all hardware versions IntelliGen ^{NT} and IntelliSys ^{NT} , IntelliVision 5 and IntelliVision 8
IGS-NT-3.0 Installation Guide	Exact description of installation and technical information about IntelliGen ^{NT} , IntelliSys ^{NT} and IntelliMains ^{NT} and related accessories

1 GENERAL INFORMATION

Document	Description
IGS-NT-3.0 Communication Guide	Exact description of data communication for IntelliGen ^{NT} , IntelliSys ^{NT} , IntelliMains ^{NT} and related accessories
IGS-NT-3.0 Troubleshooting Guide	Information on fixing the most common errors of the IntelliGen ^{NT} and IntelliSys ^{NT} generator & CHP control systems including a list of alarm messages
IGS-NT & ID-DCU Accessory Modules 02-2016	Exact description of the extension modules of the IGS ^{NT} product family, technical data, information on module installation, connection to the controllers and correct set-up
IGS-NT Safety Manual, revision 8	Manual for adapting the IntelliGen ^{NT} , IntelliSys ^{NT} , IntelliMains ^{NT} and ALL-IN-ONE generator & CHP control systems to the requirements of single-error safety as per the VDE-AR-N 4105 Application Guide
BDEW Manual, revision 0	Manual for adapting the IntelliGen ^{NT} , IntelliSys ^{NT} , IntelliMains ^{NT} and ALL-IN-ONE generator & CHP control systems to the requirements of the BDEW Medium Voltage Guideline
IS-NT-AFR 2.3.1 New Features	Description of the new features of firmware versions 2.3.1, 2.2 and 2.1
InteliMonitor 3.0 Reference Guide	Manual for monitoring and SCADA software InteliMonitor
GenConfig 3.0 Reference Guide	Manual for GenConfig configuration software
WinScope 2.0 Reference Guide	Manual for WinScope monitoring software
ECU List MOTORTECH 1.1	Technical description of the supported values and error codes

* Note that in individual cases, certain functions of the IntelliSys firmware will not be available in the IS-NT-AFR firmware of your ALL-IN-ONE.NT.

2 SAFETY INSTRUCTIONS

2.1 General Safety Instructions

MOTORTECH equipment is manufactured as state of the art and therefore safe and reliable to operate. Nevertheless, the equipment can pose risks or cause damage if the following instructions are not complied with:

- The gas engine must only be operated by trained and authorized personnel.
- Operate the equipment only within the parameters specified in the technical data.
- Use the equipment correctly and for its intended use only.
- Never apply force.
- For all work such as installation, conversion, adaptation, maintenance, and repair, all equipment must be disconnected from the mains and secured against unintentional reactivation.
- During installation, configuration, and start-up, follow the instructions in the operating manuals of the equipment and components used.
- Safety devices must not be dismantled or disabled.
- Operate the equipment only when it is in perfect working condition.
- Investigate all changes detected while operating the gas engine or ignition system.
- Ensure compliance with all laws, directives and regulations applicable to the operation of your system, including such not expressly stated herein.
- If the system is not entirely tight and sealed, gas may escape and result in explosion hazard. Upon completion of all assembly works, always check the system's tightness.
- Always ensure adequate ventilation of the engine compartment.
- Ensure a safe position at the gas engine.

2.2 Electrostatic Discharge Hazards

Electronic equipment is sensitive to static electricity. To protect these components from damage caused by static electricity, special precautions must be taken to minimize or prevent electrostatic discharge.

Observe these safety precautions while you work with the equipment or in its vicinity.

- Before performing maintenance or repair work, ensure that the static electricity inherent to your body is discharged.
- Do not wear clothing made from synthetic materials to prevent static electricity from building up. Your clothing should therefore be made of cotton or cotton mix materials.
- Keep plastics such as vinyl and Styrofoam materials as far away from the control system, the modules, and the work environment as possible.
- Do not remove the circuit boards from the housing of the device.

2 SAFETY INSTRUCTIONS

2.3 Special Safety Instructions for the Device



High voltage! Danger to life!

The terminals for voltage and current measurement must not be touched under any circumstances. Connect the grounding terminals properly.



Risk of injury or death!

The generator & CHP control system can be controlled remotely. During maintenance work on the gen-set, make absolutely sure that the engine cannot be started.

Disconnect the following connections:

- Remote control via RS232 or another communication connection
- *Rem start/stop* input

or

- *Starter, GCB close/open, MCB close/open* outputs



Operational safety!

Note that the states of the binary outputs can change during and after the configuration of the device software. Before you put the generator & CHP control system back into operation, make absolutely sure that the configuration and parameter settings match your system.



Risk of injury or death!

Note that the mains circuit breaker can be closed and the gen-set started when you disconnect at least one of the following connections on the generator & CHP control system:

- Mains voltage measurement
- Binary outputs for the control of the mains circuit breaker
- Feedback of the mains circuit breaker

To prevent automatic gen-set start or closing of the generator circuit breaker during all work on the gen-set or the switch panel, ensure the following:

- Switch the generator & CHP control system to manual mode.
- Disconnect the *Starter* and *Fuel solenoid* binary outputs or press the emergency stop button.



Operational safety!

Unqualified modifications to the system can lead to the system being disconnected from the power supply. Only make changes to the system when you are sure what the consequences are.



Risk of destruction!

Under no circumstances should you disconnect the transformer terminals (CT) of the generator & CHP control system when the system is powered up. Otherwise, the transformer could be irreparably damaged.



Operational safety!

All parameters are set to their typical values at the factory. However, the parameters of the *Basic settings* group must be adjusted before starting the gen-set for the first time. If the basic setting parameters are incorrectly set, this may cause irreparable damage to the gen-set.

2.4 Proper Disposal

After the expiration of its service life, MOTORTECH equipment can be disposed of with other commercial waste, or it may be returned to MOTORTECH. We will ensure its environmentally friendly disposal.

3 INTENDED USE

3.1 Functional Description

ALL-IN-ONE generator & CHP control systems provide all basic functions for monitoring, controlling, regulating, and protecting the gen-set and the system. These functions can be specifically adapted and expanded via a PLC editor. The ALL-IN-ONE controllers are particularly well-suited for gas engine gen-sets due to the integrated functions for mixture control and control of air/gas mixers.

The ALL-IN-ONE system has a modular design and can be adapted to suit specific engines or systems via different extension modules. Up to 32 ALL-IN-ONE generator & CHP control systems can work in concert in a CAN bus segment. Built-in units for synchronizing and load sharing as well as the control of the generator and the mains circuit breaker support standby, island, parallel, and mains parallel operation. In addition, the generator & CHP control system may also be connected to external units for synchronization and load transfer.

ALL-IN-ONE generator & CHP control systems can be connected to standard ECU modules. Via the configuration software GenConfig, they can easily be adapted to new ECUs.

ALL-IN-ONE generator & CHP control systems can be operated intuitively with special displays designed for system operation or via the IntelliMonitor visualization software. User interfaces can be individually adapted to the system and specific requirements. In addition, corresponding interfaces allow remote control and remote operation of the generator & CHP control system.

3.2 Applications

ALL-IN-ONE generator & CHP control systems are expandable controllers for single and multiple gen-sets operating in island or parallel operation. They are suitable for cogeneration and other complex applications.

System Overview (Example)

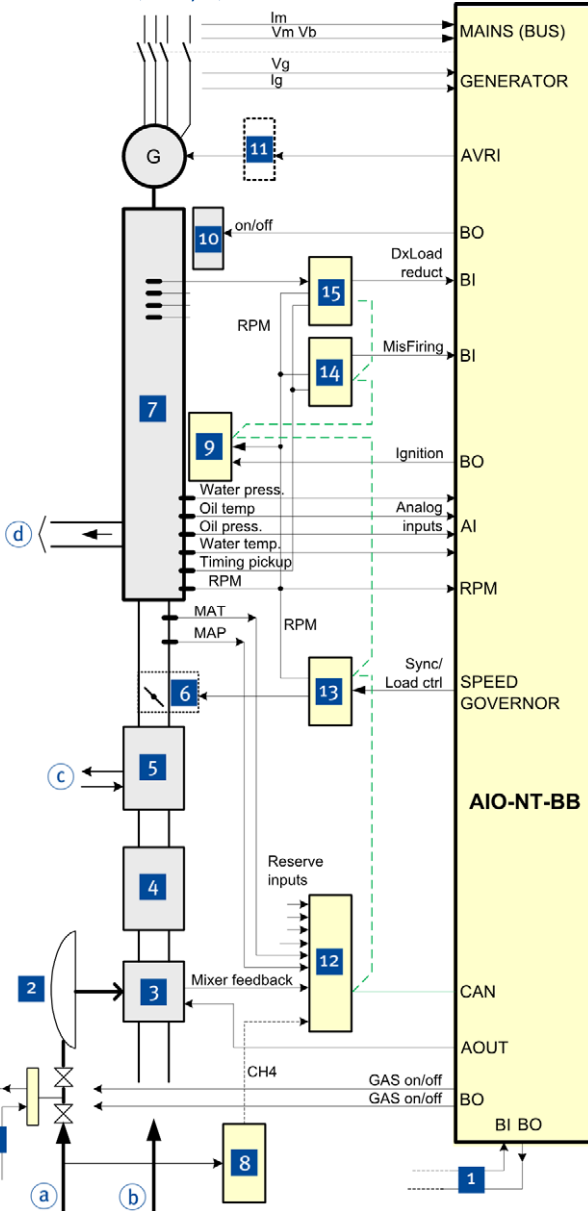

- 1 Gas ventilation test
- 2 Zero pressure regulator
- 3 Air/gas mixer
- 4 Turbocharger or compressor
- 5 Intercooler
- 6 Actuator
- 7 Gas engine
- 8 Gas analysis device
- 9 Ignition system
- 10 Starter
- 11 AVRI
- 12 Extension module (e.g. IS-AIN8)
- 13 Speed governor
- 14 Misfiring detection
- 15 Knock detection

- (a) Gas
- (b) Air
- (c) Water
- (d) Exhaust gas

4 PRODUCT DESCRIPTION

4.1 Technical Data

4.1.1 Certifications

CE

The ALL-IN-ONE.NT is certified in compliance with the following regulations:

- Low Voltage Directive 2014/35/EU
 - Safety requirements for electrical equipment for measurement, control and laboratory use according to EN 61010-1:2010
- EMC Directive 2014/30/EU
 - Immunity for residential, commercial and light-industrial environments as per EN 61000-6-1:2007 and EN 61000-6-3:2007/A1:2011/AC:2012
 - Immunity standard for industrial environments as per EN 61000-6-2:2005/AC:2005 and EN 61000-6-4:2007/A1:2011

EU DECLARATION OF CONFORMITY

The company: **MOTORTECH GmbH**
Hogrevestr. 21-23
29223 Celle, Germany

declares in sole responsibility that the products: **ALL-IN-ONE.NT (P/N 63.50.102)**
ALL-IN-ONE.NTC (P/N 63.50.104)

extension/additional modules: **IS-AIN8 (P/N 63.50.002), IS-BIN16/8 (P/N 63.50.005)**
IGS-PTM (P/N 63.50.007)
IG-AVRi TRANS/100 (P/N 63.50.010-100)
IG-AVRi TRANS/LV (P/N 63.50.010-230)
IG-AVRi (P/N 63.50.011), IGL-RA15 (P/N 63.50.015)
IG-IB (P/N 63.50.022), I-AOUT8 (P/N 63.50.054)
AFR-PCM (P/N 63.50.061)
AFR-PCLSM+PMS (P/N 63.50.062)
NT-Converter (P/N 63.50.069), Intel AIN8 (P/N 63.50.092)
Intel AIN8TC (P/N 63.50.093), IS-AIN8TC (P/N 63.50.108)
Intel IO8/8 (P/N 63.50.118)

intended purpose: **to be used on gas-Otto-engines**

comply with the provisions of the following EU Directives: **Low Voltage Directive 2014/35/EU**
EMC Directive 2014/30/EU

under consideration of the following standards: **EN 61010-1:2010, EN 61000-6-1:2007**
EN 61000-6-2:2005/AC:2005
EN 61000-6-3:2007/A1:2011/AC:2012
EN 61000-6-4:2007/A1:2011

This declaration is submitted by: **Name: Florian Virchow**
Position in company: Managing Director

Celle, 2016-08-18

Place, date



Legally binding signature

4 PRODUCT DESCRIPTION

4.1.2 Mechanical Data

The ALL-IN-ONE.NT generator & CHP control system has the following mechanical characteristics:

Feature	Value
Dimensions	194 mm x 125 mm x 93 mm (7.6" x 4.9" x 3.7") (length x width x height)
Weight	983 g (2.17 lbs)
Shape of device	See chapter <i>Overview Drawings</i> on page 26
Climatic environmental conditions	Operation: -40 °C to +70 °C max. (-40 °F to +158 °F) Operation using a USB connection: 0 °C to +70 °C max. (32 °F to +158 °F) Storage: -40 °C to +80 °C max. (-40 °F to +176 °F) 95 % air humidity max. without condensation



Observe the environmental conditions of all equipment

Also observe the environmental conditions of all equipment which is connected to the ALL-IN-ONE.NT generator & CHP control system.

4.1.3 Warning Notices on the Device

CAUTION – Risk of electric shock, do not remove cover

No user serviceable parts inside

Refer servicing to qualified service personnel

For use on a flat surface of a type 1 enclosure

Max. ambient temperature 70 °C

Use copper conductors only

Refer to installation instructions for torque values

4.1.4 Product Identification – Labeling on the Device

The numbers required for unique product identification are on the device:

- P/N: product number of the generator & CHP control system
- HW version: hardware version and production code of the generator & CHP control system
- Barcode and number: serial number of the generator & CHP control system



4.1.5 Electrical Data

The ALL-IN-ONE.NT generator & CHP control system has the following electrical characteristics:

Feature	Value
Power supply	8 V DC to 36 V DC
Required current	0.4 A at 8 V DC 0.15 A at 24 V DC 0.1 A at 36 V DC
Battery real-time clock	Measurement tolerance for battery voltage: 2 % at 24 V Service life: 10 years
Nominal frequency for frequency measurement	50 Hz to 60 Hz
Tolerance of frequency measurement	0.1 Hz

4 PRODUCT DESCRIPTION

The inputs and outputs of the ALL-IN-ONE.NT generator & CHP control system have the following electrical data:

Feature	Value
Current inputs	<p>Input nominal current (from transformer): 1 A or 5 A*</p> <p>Constant overload: 1.25 A or 6.25 A*</p> <p>Short-term overload: 12 A for 1 min</p> <p>Load (transformer output impedance): $< 0.1 \Omega$</p> <p>Input load of the transformer:</p> <ul style="list-style-type: none"> - < 0.1 VA per phase ($I_{nom} = 1$ A) - < 0.2 VA per phase ($I_{nom} = 5$ A) <p>Maximum measured current from transformer: 2 A or 10 A*</p> <p>Tolerance for current measurement: 2 % of nominal current</p> <p>Maximum peak current from transformer: 150 A for 1 s</p> <p>Maximum short-term current: 2.4 A or 12 A* for 30 s</p> <p>Maximum continuous current: 1 A or 5 A*</p> <p>* Dependent on set input voltage range</p>
Voltage inputs	<p>Nominal voltage (ph-N / ph-ph): 120 to 207 V AC or 277 to 480 V AC</p> <p>Maximum measured voltage: 150 V AC or 346 V AC</p> <p>Maximum permissible voltage: 260 V AC or 600 V AC</p> <p>Input resistance:</p> <ul style="list-style-type: none"> - $0.6 \text{ M}\Omega$ phase-to-phase - $0.3 \text{ M}\Omega$ phase-to-neutral <p>Tolerance for voltage measurement: 1 % of nominal voltage</p> <p>Measurement tolerance for kW, kWh, load sharing and reactive power sharing: 3 %</p> <p>Overvoltage class: III / 2 (EN 61010)</p>
Binary inputs	<p>Number of inputs: 16</p> <p>Input resistance: 4.7 kΩ</p> <p>Input range: 0 V DC to 36 V DC</p> <p>Voltage level for indicating a closed contact: 0 V to 2 V</p> <p>Maximum voltage level for indicating an open contact: 8 V to 36 V</p>

Feature	Value
Binary outputs	<p>Open collector</p> <p>Number of outputs: 16</p> <p>Maximum current: 0.5 A</p> <p>Maximum switching voltage: 36 V DC</p>
Analog inputs	<p>Not electrically separated</p> <p>Number of inputs: 4, unipolar</p> <p>Resolution: 10 bit</p> <p>Selectable range through jumpers: V, Ω, mA</p> <p>Maximum resistance range: 2,500 Ω</p> <p>Maximum voltage range: 5 V</p> <p>Maximum current range: 0 mA to 20 mA</p> <p>Input impedance:</p> <ul style="list-style-type: none"> - 180 Ω for mA measurement - >100 kΩ for V measurement <p>Tolerance for resistance measurement: $\pm 2\%$, $\pm 2\ \Omega$ of the measured value</p> <p>Tolerance for voltage measurement: $\pm 1\%$, $\pm 1\ \text{mV}$ of the measured value</p> <p>Tolerance for current measurement: $\pm 1\%$, $\pm 0.5\ \text{mA}$ of the measured value</p>
D+ function	<p>Maximum output current: 300 mA</p> <p>Guaranteed level for "Charging OK" signal: 80 % of supply voltage</p>
Speed pick-up input	<p>Type of sensor: magnetic pickup</p> <p>Minimum input voltage: 2 V_{pk-pk} (from 4 Hz to 4 kHz)</p> <p>Maximum input voltage: 50 V_{eff}</p> <p>Lowest measured frequency: 4 Hz</p> <p>Highest measured frequency: 10 kHz (minimum input voltage 6 V_{pk-pk})</p> <p>Tolerance for frequency measurement: 0.2 %</p>

4 PRODUCT DESCRIPTION

Feature	Value
Analog outputs	Output for speed governor: ± 10 V DC / 5 V PWM (500 Hz to 3,000 Hz), max. 15 mA AVRi output: PWM to IG-AVRi Range selectable through jumper: V, mA Current output: 0 mA to 20 mA, ± 0.3 mA Voltage output: 0 V DC to 10 V DC, max. 15 mA Maximum load resistance: 470 Ω at 9.4 V

4.1.6 Interfaces

RS232

- Speed: up to 57.6 kBd
- Maximum length: 10 m (32')
- Cable type: Cross-over cable, null modem cable
- Plug connection: D-SUB, 9-pole

RS485

- Speed: up to 57.6 kBd
- Maximum length: 1,000 m (3,280')
- Cable type: STP
- Plug connection: none

CAN

- Galvanically isolated
- Maximum CAN bus length:
 - Mode 32C: 200 m (656') for up to 32 controllers
 - Mode 8C: 900 m (2,952') for up to 8 controllers
- Speed:
 - Mode 32C: 250 kBd
 - Mode 8C: 50 kBd
- Nominal impedance: 120 Ω
- Cable type: STP
- Plug connection: none
- Nominal velocity of propagation: min. 75 %, max. 4.4 ns/m

- Cable cross-section: min. 0.25 mm²
- Maximum damping: 2 db / 100 m at 1 MHz
- Recommended cables: see section *CAN bus interface* in the IGS-NT-3.0 Installation Guide on page 122

Modbus

- Via RS232, RS485, Ethernet interface

USB

- Not insulated
- Interface USB 2.0
- Maximum length: 5 m (16')
- Speed: 115.2 kBd
- Cable type: shielded
- Plug connection: type B

4 PRODUCT DESCRIPTION

4.1.7 Overview Drawings

Dimensions

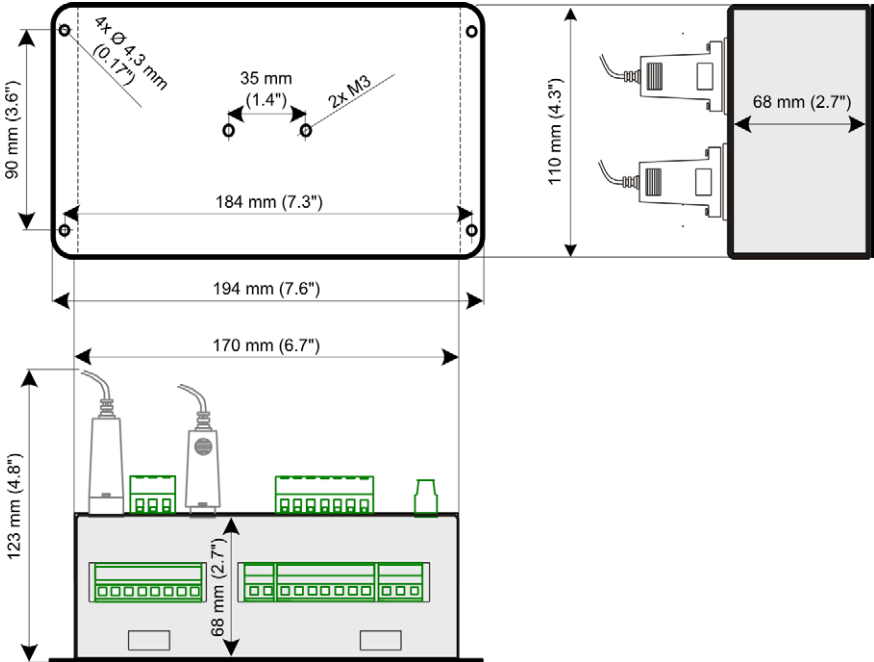

Connections

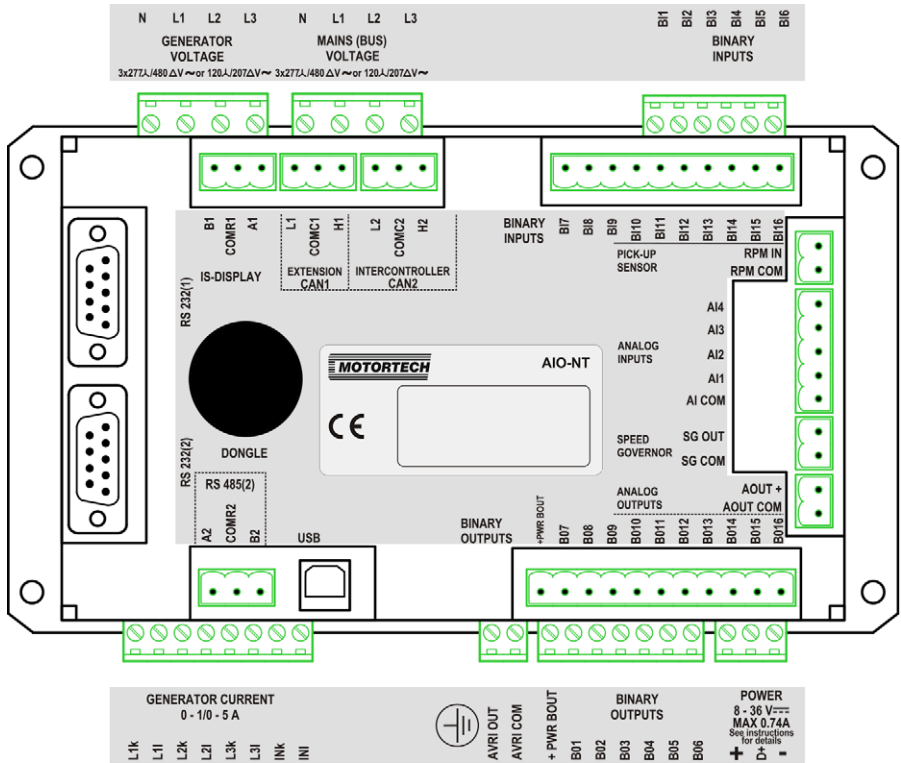

Designation	Clamps	Function
GENERATOR VOLTAGE	N, L1, L2, L3	Measurement connections for generator voltage
MAINS (BUS) VOLTAGE	N, L1, L2, L3	Measurement connections for mains/bus voltage
BINARY INPUTS	B1 to B16, B7 to B16	The binary inputs are activated when the negative potential is switched. When using the optional plug-on modules I-HSS-BIN6 and I-HSS-BIN10, the binary inputs are activated when the positive potential is switched.

4 PRODUCT DESCRIPTION

Designation	Clamps	Function
RS 232(1)	–	<p><i>Comms settings: RS485(1)conv. = DISABLED:</i></p> <ul style="list-style-type: none"> – Communication port COM1 is at RS 232(1) – Connection of up to three AIO.NT Displays / AIO.Vision 5 / AIO.Vision 8 to IS-DISPLAY
IS-DISPLAY	B1, COMR1, A1	<p><i>Comms settings: RS485(1)conv. = ENABLED:</i></p> <ul style="list-style-type: none"> – RS 232(1) without function – Rerouting of communication port COM1 to IS-DISPLAY
EXTENSION CAN1	L1, COMC1, H1	Connection for CAN bus connection with extension modules of the ALL-IN-ONE
INTERCONTROLLER CAN2	L2, COMC2, H2	Connection options for internal CAN bus communication with other controllers, modules IG-IB and I-LB and up to four AIO.Vision 8
PICK-UP SENSOR	RPM IN, RPM COM	Connection for the magnetic pickup for speed measurement
DONGLE	–	Slot for ALL-IN-ONE hardware dongle
ANALOG INPUTS	AI4 to AI1, AI COM	Configurable analog inputs
SPEED GOVERNOR	SG OUT, SG COM	Output interface for speed governor
RS 232(2)	–	<p><i>Comms settings: RS485(2)conv. = DISABLED</i></p> <ul style="list-style-type: none"> – Communication port COM2 is at RS 232(2) – RS 485(2) without function
RS 485(2)	A2, COMR2, B2	<p><i>Comms settings: RS485(2)conv. = ENABLED</i></p> <ul style="list-style-type: none"> – RS 232(2) without function – Rerouting of communication port COM2 to RS 485(2)
USB	–	USB 2.0 connection
BINARY OUTPUTS	+PWR BOUT, BO7 to BO16, +PWR BOUT, BO1 to BO6	The binary outputs switch to negative potential.
ANALOG OUTPUTS	AOUT +, AOUT COM	Configurable analog output

Designation	Clamps	Function
GENERATOR CURRENT 0-1/0-5 A	L1k, L1l, L2k, L2l, L3k, L3l,	Measurement connections for the generator current
	INk, INl	Measurement connections for neutral/mains current
-	AVRI OUT AVRI COM	Interface for IG-AVRi
POWER 8-36V	+, -	Connection for power supply 8 V DC to 36 V DC
	D+	D plus connection

4 PRODUCT DESCRIPTION

Jumpers

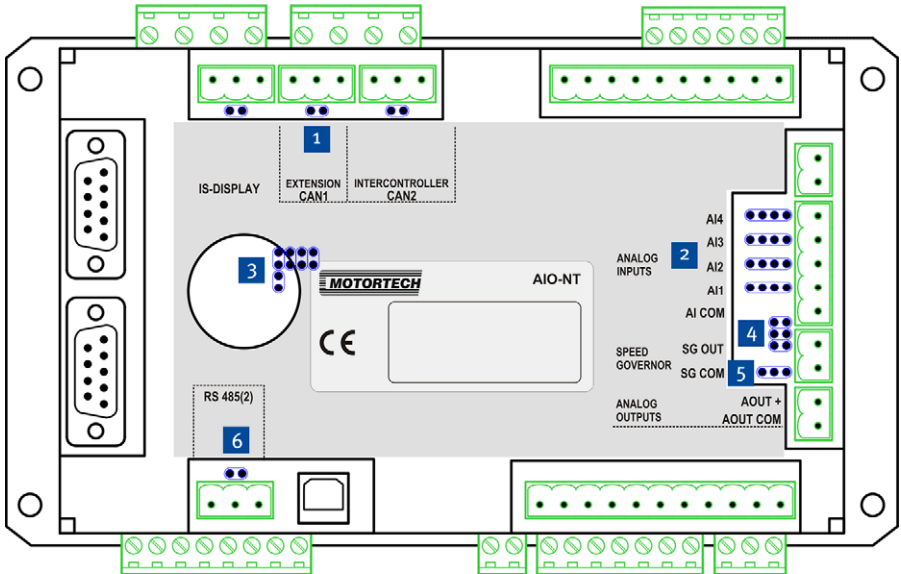

Pos.	Jumpers
1	From left to right: pull-down bias, 120 Ω, pull-up bias, 120 Ω, 120 Ω
2	From top to bottom: setting of analog inputs from AI4 to AI1 Current input 0 – 25 mA Voltage input 0 – 5 V Resistance input 0 – 2,400 Ω
3	Boot jumper (lower pair, all other jumpers are defined for internal use)
4	Setting of speed governor output PWM VoutR VOut
5	Setting of analog output Voltage 0 – 10 V DC Current 0 – 20 mA
6	From left to right: pull-up bias, 120 Ω, pull-down bias

5 INSTALLATION INSTRUCTIONS

5.1 Unpacking

Unpack the device, taking care not to damage it, and ensure that the operating manual is always stored with the generator & CHP control system and is easily accessible. Check the contents for completeness and verify that the device type meets your application requirements.

Scope of Supply

The scope of supply of the ALL-IN-ONE.NT consists of the following components:

- ALL-IN-ONE.NT generator & CHP control system
- Storage device (USB flash drive or CD-ROM) with software for configuration of the generator & CHP control system, operating manual and further documentation

The following is also included with the HSS version:

- Plug-on module I-HSS-BIN6
- Plug-on module I-HSS-BIN10
- Installation instructions for plug-on modules I-HSS-BIN

5.2 Installation

Information for installing the ALL-IN-ONE.NT generator & CHP control system can be found in the IGS-NT-3.0 Installation Guide from ComAp. The ALL-IN-ONE.NT generator & CHP control system corresponds to the generator & CHP control system IS-NT-BB.

5 INSTALLATION INSTRUCTIONS

5.3 Wiring

Information on the wiring of the ALL-IN-ONE.NT generator & CHP control system can be found in the IGS-NT-3.0 Installation Guide from ComAp. The ALL-IN-ONE.NT generator & CHP control system corresponds to the generator & CHP control system IS-NT-BB. Also note the following wiring example:

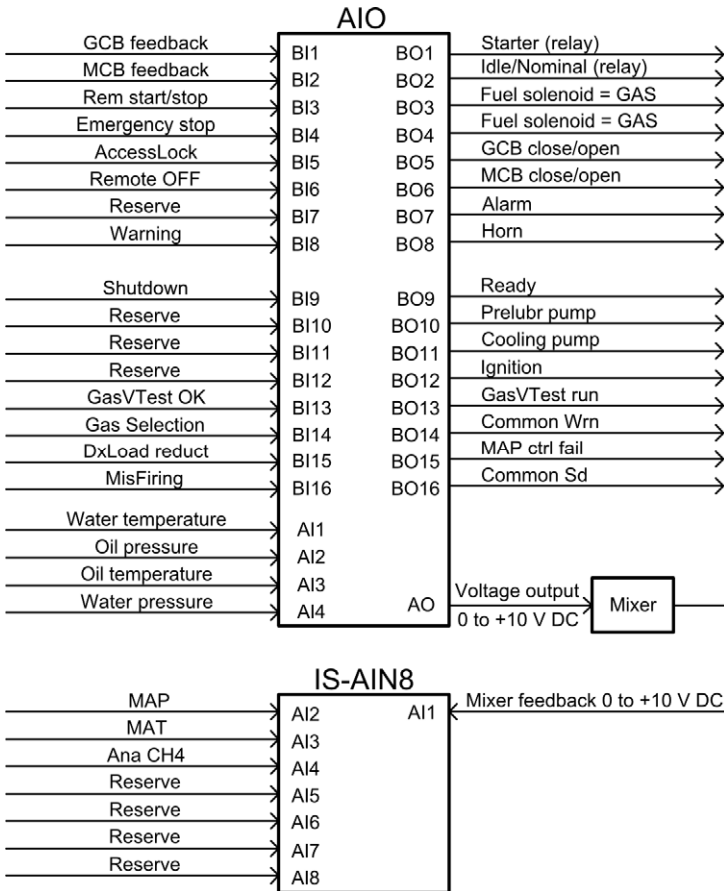

6 FUNCTIONS

The following sections describe the extended functions of the AFR firmware of your ALL-IN-ONE.NT generator & CHP control system which are not available in the standard firmware.

For a description of all other functions, read the section *Functions* in the IGS-NT-3.0 Reference Guide from ComAp for your selected archive. The ALL-IN-ONE.NT generator & CHP control system corresponds to the generator & CHP control system IS-NT-BB.

6.1 Operation Modes

When using an AFR archive, the ALL-IN-ONE.NT can be operated in the following operation modes:

- **OFF**
In this operation mode, the ALL-IN-ONE.NT opens the generator circuit breaker and stops the engine immediately without soft unload and cooling. The ALL-IN-ONE.NT is then in the *not ready* operation state and cannot be started in this state. Depending on the setting of the *AMF settings: MCB opens on* parameter, the ALL-IN-ONE.NT behaves as follows:
 - **MAINSFAIL:** The ALL-IN-ONE.NT opens the mains circuit breaker when the mains is not available.
 - **GEN RUNNING:** The mains circuit breaker remains permanently closed as long as the gen-set is not running and no voltage is produced.
- **MAN**
The engine can be started and stopped manually via the *Start* and *Stop* keys/buttons or via corresponding signals at the *StartButton* and *StopButton* binary inputs. When the engine is running and the bus is voltage-free, the generator circuit breaker can be manually closed, or when there is voltage in the bus, synchronization can be initiated. The mains circuit breaker can also be manually opened or closed regardless of the mains status. Automatic start as well as remote control via the *Sys start/stop* or *Rem start/stop* inputs is not supported in this operation mode.
- **SEM**
The engine can be started and stopped manually via the *Start* and *Stop* keys/buttons or via corresponding signals at the *StartButton* and *StopButton* binary inputs. All other processes including opening and closing the generator circuit breaker are performed automatically. However, automatic gen-set start is possible when using the AMF function (automatic gen-set start in the event of mains failure).
- **AUT**
In this operation mode, the generator & CHP control system runs completely automatically. The *Start*, *Stop*, *MCB* and *GCB* keys/buttons do not trigger a function. The processes for gen-set start and stop are performed automatically. The engine can be started and stopped as follows:
 - Via the *Rem start/stop* binary inputs (SPtM and SPI application)
 - Via the peak start/stop function (SPtM and SPI application) = Auto start of the gen-set depending the mains power received
 - Via the AMF function (SPtM application) = Automatic start of the gen-set in the event of mains failure

6 FUNCTIONS

- Via the power control function (MINT application)
- Via the *Sys start/stop* binary inputs (MINT application)

Note that the TEST operation mode, which is available in certain archives in the standard firmware, is not available when using the AFR firmware.

For a detailed description of the operation modes, read the section *Mode and function description* in the IGS-NT-3.0 Operator Guide from ComAp. The ALL-IN-ONE.NT generator & CHP control system corresponds to the generator & CHP control system IS-NT-BB.

6.2 Function Enabling via Hardware Dongle

Particular functions of the ALL-IN-ONE.NT generator & CHP control system have to be activated via a hardware dongle that is inserted into the device. The hardware dongles from MOTORTECH listed below enable the following functions:

AFR-PCM

- For SPI and SPTM applications
- Enables single island or single parallel with mains operation
- Air/fuel ratio function for lean burn gas engines

AFR-PCLSM+PMS

- For MINT and Combi applications
- Enables multiple island parallel or multiple parallel with mains operation
- Air/fuel ratio function for lean burn gas engines
- Load sharing
- VAR sharing
- Power management operation via CAN bus
- Optimization of the number of running engines:
Power control based on kW, kVA, percentage load or operating hours

6.3 Measuring Inputs for Cylinder Temperatures

If an AFR archive is selected, there are 24 logical analog inputs available for the measured values of the cylinder temperatures.

6.4 Gas Ventilation Test Before Engine Start

Before every engine start, the ALL-IN-ONE.NT generator & CHP control system can check the gas supply for leaks. When the *GasVTest run* binary output is closed, the generator & CHP control system initiates the gas ventilation test for the connected test unit and starts the *AFR control: GasVTest del* timer. The generator & CHP control system starts the engine as soon as it receives a positive test result within the set *AFR control: GasVTest del* time span via the *GasVTest OK* binary input. If it does not receive feedback within this time span, it does not start the engine.

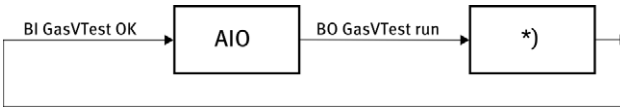

*) Gas ventilation test unit

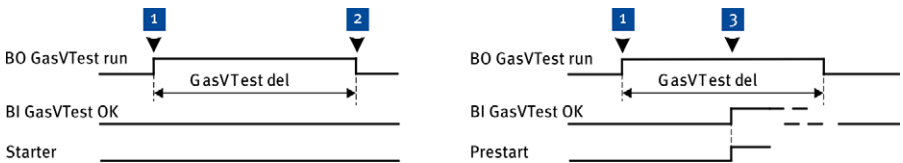

- 1 Start command
- 2 Shutdown
- 3 Engine start

When the gas ventilation test is activated, the *GasVTest run* binary input is activated before every engine start by one of the following events:

- Closing the *Rem start/stop* binary input (remote-controlled start/stop) in *AUT* operation mode
- Pressing the *Start* key in the *MAN* and *SEM* operation modes

Note the following condition (only firmware IS-NT-AFR 2.3.1):

- The *GasVTest OK* binary input can remain switched in all gen-set states. However, the input must be open as soon as the ALL-IN-ONE.NT initiates the gas ventilation test. Otherwise, it does not start the engine and switches the *Sd GasVTestFdb* binary output.

Please note the following exceptions:

- If the gen-set is automatically started due to a short mains failure, the gas ventilation test is omitted.
- If the *Sd override* binary input is active, engine start is also possible if the gas ventilation test has a negative result.

6 FUNCTIONS

6.5 Overspeed Protection at Engine Start

You can set your own overspeed threshold for engine start. At the time of engine start, the ALL-IN-ONE.NT will then perform a test to make sure that the speed does not exceed this threshold. Otherwise, the generator & CHP control system cancels engine start and registers a false start.

For more information on engine start, read the section *Engine states* in the IGS-NT-3.0 Reference Guide from ComAp for your selected archive.

6.6 Analog and Binary Mixer Control

The connected air/gas mixer can be controlled via analog and digital signals.

Analog Mixer Control

The current targeted position is issued as a position signal at the *MixerPosition* analog output. The size and range of the signal output depends on the assigned physical output. Note that, in addition to the configuration of the output via GenConfig, the output size generally has to be set via a jumper on the board of the respective equipment.

Binary Mixer Control

At the binary outputs *Mixer up* and *Mixer down*, a closed output signals the direction of movement of the mixer until the target position has been reached and reported back correspondingly via the analog input *Mixer fdb*. A movement in the closed direction is signaled via *Mixer down*, a movement in the open direction via *Mixer up*.

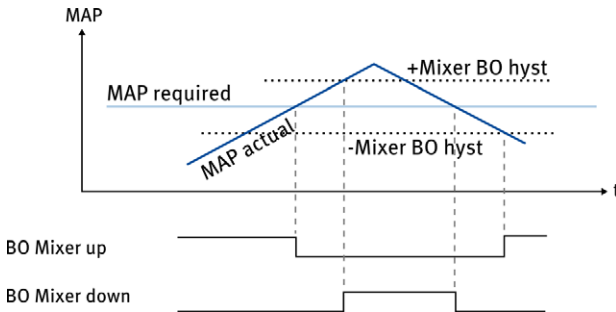

The closing of the outputs *Mixer up* and *Mixer down* arises from the difference between the target mixer position and the actual mixer position reported back via the analog input *Mixer fdb*. Consequently, the binary mixer control can only work if the actual mixer position is reported back to it via the analog input *Mixer fdb*. You set the maximum permissible difference between the target and reported mixer position via the *AFR control: Mixer BO hyst* parameter.

6.7 Adjustable Number of Synchronization Attempts

You can set a maximum number of synchronization attempts. If the ALL-IN-ONE.NT interrupts the synchronization within the maximum set synchronization timeout (*Sync/Load ctrl: Sync timeout*) due to impermissible mains or generator values, the ALL-IN-ONE.NT repeats synchronization as soon as the values are in the permissible range once again. If the last synchronization attempt is also not successful, the ALL-IN-ONE.NT initiates a slow stop of the engine.

6.8 Additional Test Parameters for Mains Voltage

Additional Thresholds for Mains Over-/Undervoltage

For testing for mains over- / and undervoltage, two additional thresholds are available with *Mains protect: Mains >>V MP* and *Mains protect: Mains <<V MP*. If these thresholds are exceeded, the generator & CHP control system opens, depending on the application, either the generator circuit breaker or the mains circuit breaker without unloading the gen-set in order to protect the gen-set. In this way, you can set up a two-level mains over- and undervoltage test.

Mains Voltage Average

For voltage stability in the mains, the generator & CHP control system uses the *Mains protect: Mains Avg>V MP* parameter to check that a certain adjustable mains voltage average is not exceeded by any of the three phases for a time span of 10 minutes. If at least one phase exceeds the mains voltage average, the generator & CHP control system opens the mains circuit breaker. You can use this parameter to contribute to voltage stability in the mains as per the specifications of the VDE V 0126-1-1:2013-08 standard.

6.9 Adjustable Filter for Active Power Measured Values

If active power measured values fluctuate strongly, which are generally amplified by the PID control loop of the mixture control through the speed governor output, you can set a filter for the active power measured values if necessary. With this filter, you determine from how many measured values the ALL-IN-ONE.NT should constantly calculate the average to reduce the fluctuations.

Note that the phase of the measurement signal is shifted slightly by the filter, which can in rare cases lead to an overprecise PID control loop in mixture control (for example, swinging back and forth of load and PID control).

6 FUNCTIONS

The following diagram illustrates the mode of action of the filter. The curves were shifted to the y-axis to provide a better illustration.

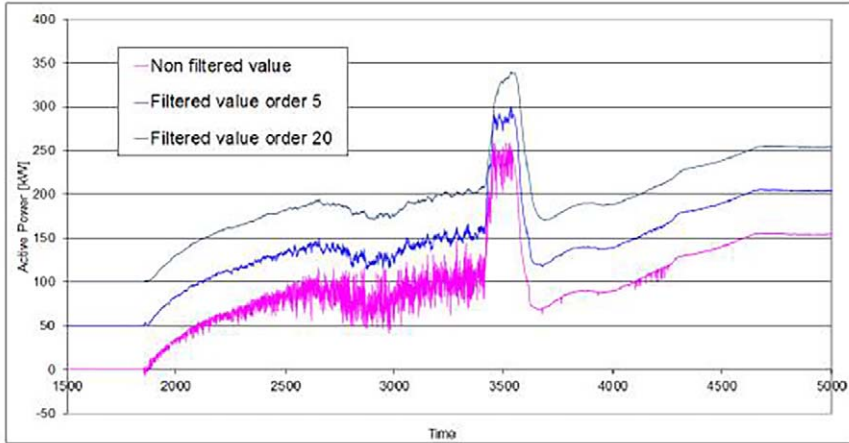

6.10 Mixture Control

The automatic air/fuel mixture control of the ALL-IN-ONE.NT is designed for lean burn operation. Depending on the mixture control mode and the state of the gen-set, the ALL-IN-ONE.NT drives to fixed mixer positions for an optimal air/fuel ratio or sets the mixer position according to a manifold pressure characteristic. The fixed mixer positions of the ALL-IN-ONE.NT can also be adjusted to the methane content of the inflowing gas.

For more information, read the following sections.

6.10.1 Fixed Mixer Positions

The ALL-IN-ONE.NT drives to the following fixed mixer positions depending on the respective gen-set state:

- Start position: Position of the mixer at engine start and simultaneously rest position when the engine is not in operation. This position is approached in the event of an engine stop as soon as the ALL-IN-ONE.NT has shut off the engine.
- Run position: Position of the mixer when running without load. It is approached at engine start after the starter speed has been reached.
- Low power position: Position of the mixer running with load below the power-dependent control range. This position is approached after closing the generator circuit breaker while loading.

In the *AFR control* group, you can set two sets of fixed mixer positions for operations using two types of gas or gas qualities. You can use the *Gas Selection* logical binary input to switch between these position sets.

Position set	Gas selection input	Mixer positions
1	open	<i>StartPosition1, RunPosition1, LoPwrPosition1</i>
2	closed	<i>StartPosition2, RunPosition2, LoPwrPosition2</i>

If the position set is switched when the engine is running, the respective fixed mixer position (for example, run position) is changed by 50 % a minute with a ramp.

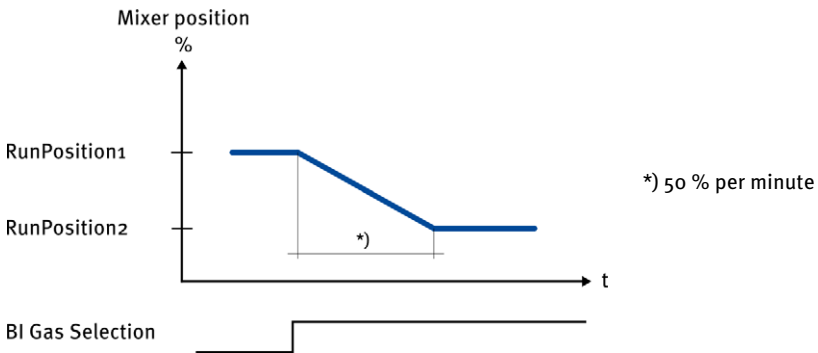

To prevent false starts, for example when the gas quality fluctuates, you can set an offset for the start position via the *AFR control: StartP Offsetx* parameter. After repeated false starts, the start position is shifted by this offset before the last start attempt.

6 FUNCTIONS

6.10.2 Methane Content Adjustment of the Fixed Mixer Positions

To optimize engine start, idling and running without load, the fixed mixer positions can be made dependent on the methane content of the inflowing gas (logical analog input *Ana CH₄*). In this way, the fixed mixer positions can be adjusted to the fluctuating methane content of the inflowing gas.

The adjustment to the methane content takes place using a characteristic with two setpoints. For this, you define the optimal mixer position at engine start for a methane content of 40 % (parameter *AFR control: MxPos40%CH₄*) and of 60 % (parameter *AFR control: MxPos60%CH₄*). The ALL-IN-ONE.NT calculates the mixer position linearly for all other methane values.

Methane content

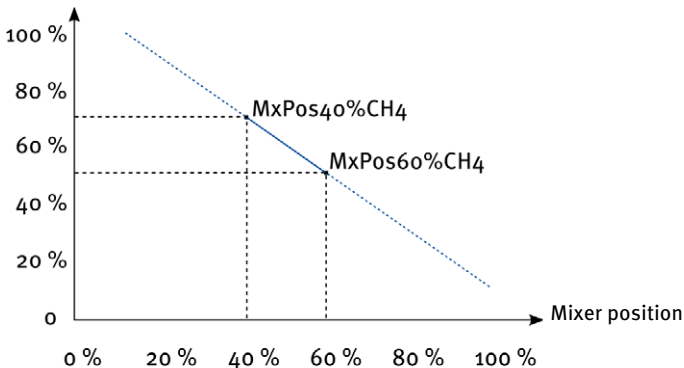

Two modes are available for the methane content adjustment of the fixed mixer positions:

- *ENA-FIX*: The ALL-IN-ONE.NT determines the fixed mixer positions solely using the characteristic. The configured positions are not taken into account.
- *ENA-STEP*: The ALL-IN-ONE.NT determines the fixed mixer positions using the characteristic (=Characteristic position). The ALL-IN-ONE.NT shifts the run position and the low power position based on the configured difference to the start position.

Mixer position	Position determination in ENA-STEP mode
Start position	Characteristic position
Run position	Characteristic position + (run position – start position)
Low power position	Characteristic position + (low power position – start position)

If the measured methane values at the *Ana CH₄* analog input are outside the configured permissible range of the sensor, the generator & CHP control system drives to the configured fixed mixer positions.

6.10.3 Power-Dependent Air/Fuel Mixture Control

The AFR firmware of your ALL-IN-ONE.NT has an air/fuel mixture control that produces the optimal air/fuel ratio by controlling the manifold pressure.

The ALL-IN-ONE.NT determines an optimal target value for the manifold pressure from a characteristic depending on the gen-set power. The ALL-IN-ONE.NT compares this target value with the current manifold pressure. If there is a deviation between both values, the generator & CHP control system changes the air/fuel ratio via the connected air/gas mixer until the current manifold pressure corresponds to the target value.

Two to five setpoints and the reference temperature of the characteristic can be defined for the manifold pressure characteristic. The manifold pressure characteristic defines the manifold pressure (*AFR control: MAPx*) required for a certain gen-set power (*AFR control: MAPx power*) for up to five setpoints. The ALL-IN-ONE.NT performs a linear calculation to determine the values between two setpoints.

Manifold absolute pressure (*MAP*)

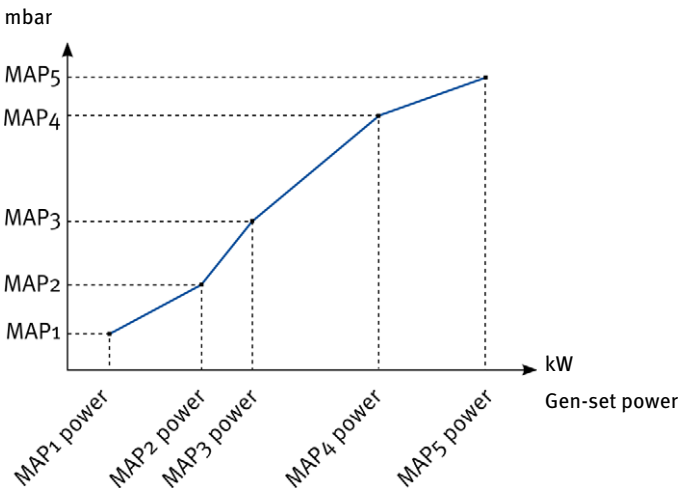

If the actual manifold air temperature deviates from the reference temperature, the manifold pressure target value can be corrected proportionally by a definable factor depending on the size of the difference measured.

The power-dependent air/fuel mixture control of the ALL-IN-ONE.NT kicks in as soon as the gen-set power is in the power-dependent control range. The power-dependent control range begins with the first low setpoint. Below the power-dependent control range, the generator & CHP control system targets the low power fixed mixer position.

6 FUNCTIONS

The power-dependent air/fuel mixture control is available in the mixture control modes *AUTOMATIC* and *AUT-PAR*. It is restricted to parallel operation in the mixture control mode *AUT-PAR*.



Alternatives: combustion chamber temperature, lambda

Alternatively, you can also use temperature sensors instead of pressure sensors to indirectly achieve the optimal air/fuel ratio by controlling the average combustion chamber temperature. Also, you can use lambda sensors to achieve the optimal air/fuel ratio directly.

6.10.4 Mixture Control Modes

The ALL-IN-ONE.NT mixture control can be operated in the following modes:

- Manual mode (*MANUAL*)
- Automatic mode (*AUTOMATIC*)
- Automatic mode with power-dependent air/fuel mixture control in parallel operation (*AUT-PAR*)

MANUAL

In the *MANUAL* mixer control mode, the targeted mixer position is defined solely by the *AFR control: Mixer position* parameter. This position is maintained in any condition of the engine and applies to the second air/gas mixer as well, if connected.

AUTOMATIC

In the *AUTOMATIC* mixture control mode, the ALL-IN-ONE.NT moves to the configured fixed mixer positions (start position, run position, low power position) depending on the gen-set state. In addition, when the generator circuit breaker is closed (closed binary input *GCB feedback*), the power-dependent air/fuel mixture control is active provided that the gen-set power reported back is within the power-dependent control range. The mixer position control based on manifold pressure is provided independently for both air/gas mixers.

AUT-PAR

This mode corresponds to the mixture control mode *AUTOMATIC*. However, in the *AUT-PAR* mode, the ALL-IN-ONE.NT restricts the power-dependent air/fuel mixture control to parallel operation. The ALL-IN-ONE.NT evaluates the position of the mains circuit breaker (binary input *MCB feedback*) for this purpose. In island operation, the ALL-IN-ONE.NT always moves to the low power position when the generator circuit breaker is closed (closed *GCB feedback* binary input) and the engine is running.

For example, the *AUT-PAR* mixture control mode can be used in cases in which the settings of the power-dependent air/fuel mixture control are not suitable for island operation. This allows you to ensure that the ALL-IN-ONE.NT moves to a safe mixer position in island operation in the event of a mains failure.

6.11 Operation with Two Air/Gas Mixers

The ALL-IN-ONE.NT generator & CHP control system can control two air/gas mixers if the system is built as follows:

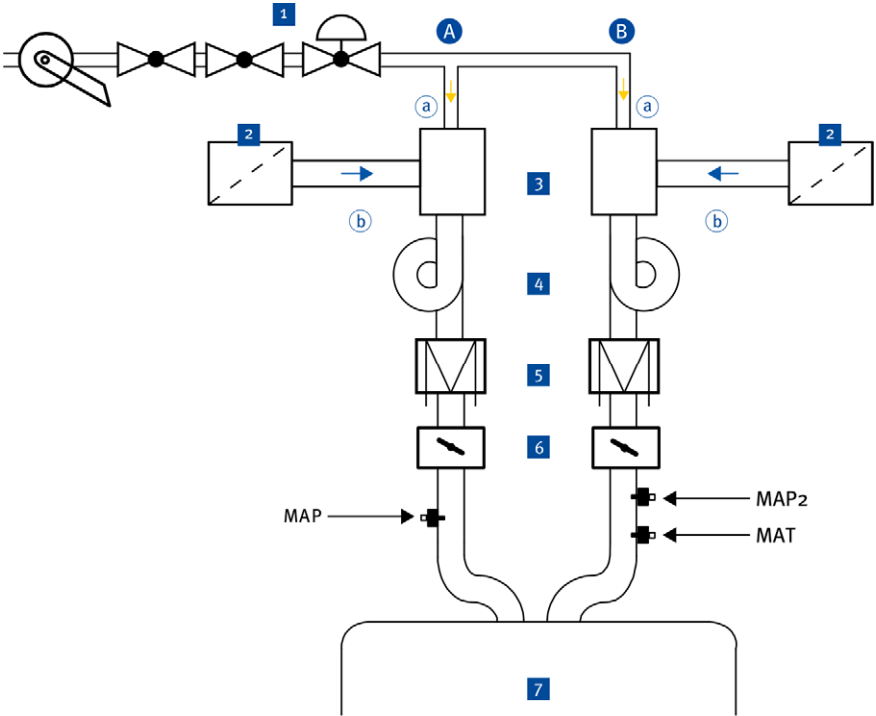

- 1 Gas train
- 2 Air filter
- 3 Air/gas mixer
- 4 Turbocharger

- 5 Intercooler
- 6 Throttle
- 7 Engine

- A Bank A
- B Bank B
- a Gas
- b Air



Position of sensors

For the highest possible precision of the mixture control, MOTORTECH recommends installing the sensors for manifold pressure and manifold temperature behind the throttle.

6 FUNCTIONS

The power-dependent air/gas mixture control is executed for both air/gas mixers independently of each other, but on the basis of the same manifold pressure characteristic. Use the following inputs and outputs for the second air/gas mixer:

- Logical analog input *MAP2*
Note that the sensor inputs for the *MAP* and *MAP2* manifold pressure must be configured with the same resolution and the same signal range.
- Logical analog input *Mixer fdb2*
Mixer fdb2 must cover the same position range as *Mixer fdb* (generally 0 to 100 %).
- Logical binary outputs *Mixer up 2* and *Mixer down 2*
- Logical analog outputs *MixerPosition2*, *MixerFeedback2*, *MAP actual2*

The *AFR control: Second Mixer* parameter must be set to *ON*, so that the generator & CHP control system can control the second air/gas mixer.

The following illustrations demonstrate the control of air/gas mixers by the ALL-IN-ONE.NT (AFR=air/fuel ratio):

Control of One Air/Gas Mixer

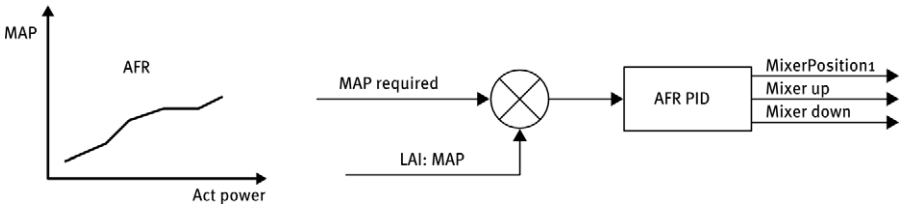

Control of Two Air/Gas Mixers

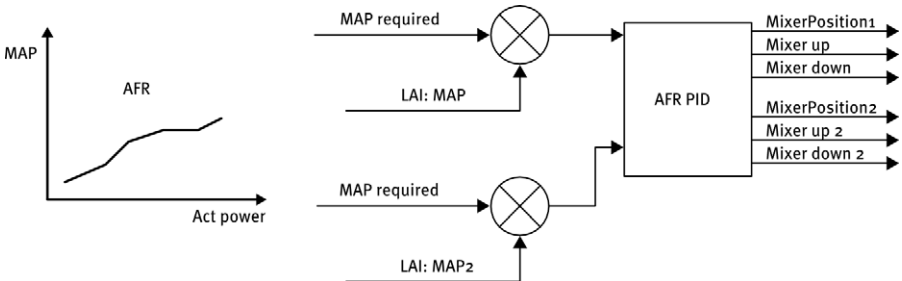

6.12 Misfire Protection

The status signal of an external misfire detection can be assigned to the *MisFiring* binary input. The signal indicates the presence of misfires via a closed input. The *MisFiring* binary input is evaluated by the ALL-IN-ONE.NT generator & CHP control system solely when the power-dependent air/fuel mixture control is active (see *Power-Dependent Air/Fuel Mixture Control* on page 41). With a closed input, it initiates the following measures to prevent misfires:

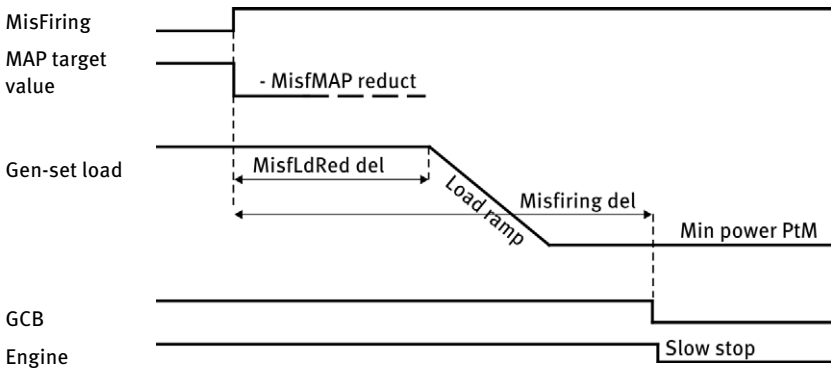

- The generator & CHP control system first changes the calculated manifold pressure target value by the configured *AFR control: MisfMAP reduct* correction value. This makes it possible to lubricate the engine in the event of misfiring.
- If misfiring is still signaled via the input, the generator & CHP control system unloads the gen-set after expiration of the *AFR control: MisfLdRed del* time span to the set minimum power in parallel operation (*Gener protect: Min power PtM*) in accordance with the set load ramp (*Sync/Load ctrl: Load ramp*).
- If misfiring is still signaled via the input, the generator & CHP control system initiates a slow stop of the engine after expiration of the *AFR control: Misfiring del* time span.
- A shutdown is immediately initiated by the generator & CHP control system when gen-set unloading is initiated for the sixth time in one hour due to misfiring. Internal counting is reset when no unloading due to misfiring is initiated within an hour or the engine has been stopped.

6 FUNCTIONS

6.13 Detonation Control

The status signal of an external knock detection (for example DetCon20), which indicates knocking combustion in the engine via a closed input, can be assigned to the *DxLoad reduct* binary input. The *DxLoad reduct* binary input is evaluated by the ALL-IN-ONE.NT generator & CHP control system solely when the power-dependent air/fuel mixture control is active (see *Power-Dependent Air/Fuel Mixture Control* on page 41). With a closed input, it initiates the following measures to prevent knocking combustion:

- The generator & CHP control system first unloads the gen-set up to the set minimum power in parallel operation (*Gener protect: Min power PtM*) in accordance with the set load ramp.
- If the input still signals knocking combustion, the generator & CHP control system initiates an engine shutdown after expiration of the *AFR control: Knocking del* time span.
- The generator & CHP control system also initiates a shutdown if the *DxLoad reduct* binary input closes six times in one hour. The internal counting is reset when no knocking is signaled on the input within one hour or the engine has been stopped.

6.14 Conduct with Off Load Protection

When an AFR archive is selected, the following additional functions are available for off load protection, which are described in the next sections.

6.14.1 Adjustable Idle Time

For off load protection, you can use the *Mains protect: AfMainsFIRun* parameter to set the maximum time the gen-set should run in the *AUT* operation mode after opening the generator circuit breaker before the gen-set is shut off if mains is not available. Note that the *Mains protect: AfMainsFIRun* timer is not displayed via the AIO.Vision displays or in the IntelliMonitor SCADA software.

When mains is available again, the ALL-IN-ONE.NT ensures for the set *Mains protect: FwRet break xx* time spans that the mains measured values are stable before it initiates reverse synchronization. This applies both for cases in which the engine is still running (see example 1) and in which it has already been shut off (see example 2).

Example 1



Example 2

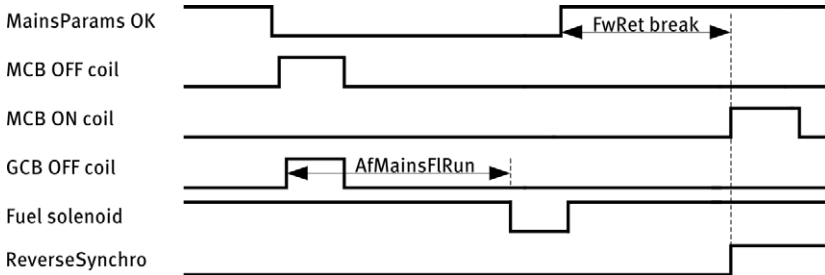

For certain mains alarms, you can set specific time spans for the test for stable mains measured values:

- Mains overvoltage alarm: *Mains protect: FwRet break >U*
- Mains undervoltage alarm: *Mains protect: FwRet break <U*
- Mains overfrequency alarm: *Mains protect: FwRet break >f*
- Mains underfrequency alarm: *Mains protect: FwRet break <f*
- Vector shift alarm: *Mains protect: FwRet break VS*

If several mains alarms have been triggered, the ALL-IN-ONE.NT takes into account the longest corresponding *Mains protect: FwRet break xx* time span.

Configure the off load protection at the *MainsParams OK* logical binary output or at the output of an external mains monitoring module.



Special case: vector shift protection with SPTM application

Scenario:

- You are using an AFR archive for SPTM applications.
- The *Mains protect: VectorS CB sel* parameter is set to *GCB* so that the ALL-IN-ONE.NT opens the generator circuit breaker if there is a vector shift alarm.

In this case, the ALL-IN-ONE.NT behaves as follows: After opening the generator circuit breaker, the ALL-IN-ONE.NT checks the mains voltage and the mains frequency for stable values. If these are stable and there is not yet a mains undervoltage alarm (*Mains protect: Mains < V del* parameter) or a mains underfrequency alarm (*Mains protect: Mains < f Del* parameter), the ALL-IN-ONE.NT immediately initiates reverse synchronization without waiting for the *Mains protect: FwRet break VS* time span.

Recommendation:

To prevent this from happening, set the *Mains protect: Mains < V del* and *Mains protect: Mains < f Del* time spans to a value longer than one second.

For more information on the off load protection, read the section *Protections and Alarm Management* in the IGS-NT-3.0 Reference Guide from ComAp for your selected archive.

6.14.2 Resetting the Overspeed Alarm

Via the *Engine protect: BoOvrSpdReset* parameter, you set the behavior of the ALL-IN-ONE.NT in the *AUT* operation mode when it registers overspeed in the context of off load protection.

If the ALL-IN-ONE.NT opens the generator circuit breaker in the context of off load protection, it is possible that the ALL-IN-ONE.NT will register overspeed after its opening and trigger an overspeed alarm. In this case, the overspeed alarm would prevent an automatic restart of the gen-set, even if the alarms which triggered the off load protection no longer exist.

You can use the *Engine protect: BoOvrSpdReset* parameter to set that the overspeed alarm is automatically reset in the above case so a restart of the gen-set is not blocked.

6.15 Start Blocking after Engine Stop

The *Engine protect: StartBlockDel* parameter can be used to disable engine start after an engine stop for a set time span. For example, you can use this function when the engine shaft needs some time before it actually stands still even though no revolutions are measured. In this manner, you prevent the engine from being damaged by an early start.

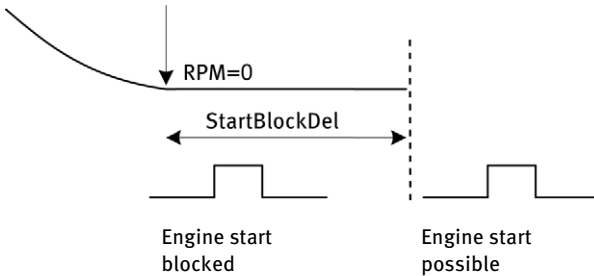

6.16 Signaling Active Mains Protections

When using an archive for independent parallel island operation of a gen-set (SPI), the ALL-IN-ONE.NT signals via the *OFF coil test* binary output that a mains protection has been triggered due to impermissible mains parameters. You can use this output to show that mains protections are active. As soon as the mains parameters are back in the permissible range, the generator & CHP control system switches off the pulse.

6.17 Timer for Engine Shutdown

Using the *Engine protect: ServiceTimeSd* parameter, you can define after how many operating hours the gen-set should be stopped. For example, you can use this function when the gen-set must be serviced after a certain number of operating hours and is no longer to be operated under any circumstances.

6.18 Alarm Notifications – Automatic Activation/Deactivation

With the parameters *AcallChx-Type* and *AcallChx-Addr* in the *Act. calls/SMS* group, you can set that up to three recipients are informed about certain generator & CHP control system events with a call, an email or an SMS. Depending on certain conditions, these parameters can be activated or deactivated during operation by assigning force values. In this way, you can for example control at what time the recipients configured via the *Act. calls/SMS: AcallChx-Addr* parameters receive the alarm notifications.

For more information on how the alarm notifications work, read the section *Remote Alarm Messaging* in the IGS-NT-3.0 Reference Guide from ComAp for your selected archive.

6 FUNCTIONS

6.19 Operation with MOTORTECH® Devices

Depending on the device, you can integrate certain MOTORTECH devices in the module configuration as an extension module or electronic control unit (ECU) using the GenConfig configuration software.

Additional Extension Modules

You can add the following devices as extension modules in the module configuration if an AFR archive is selected, provided these devices are connected to the ALL-IN-ONE.NT via the CAN bus:

- DetCon2o detonation controller from MOTORTECH
- SC100 electronic speed controller (selection: *ECON-4*) from MOTORTECH
- ECON-4 digital speed governor from ComAp
- I-Step stepper motor driver from ComAp

Additional parameter groups (*setpoints*) are available for device configuration corresponding to your selection. Additional value groups (*values*) are available for displaying device values corresponding to your selection. You can have device-specific views displayed according to your selection on the ALL-IN-ONE.NT, ALL-IN-ONE.Vision 5 and ALL-IN-ONE.Vision 8 displays.

MOTORTECH ECUs

If you have set *ECU list - Motortech.esl* in the GenConfig configuration software under *Options -> ESL files*, you can add the following MOTORTECH devices to the module configuration if an MIC archive is selected, provided these devices are connected to the ALL-IN-ONE.NT via the CAN bus:

- MIC3/4/5 ignition controller (selection: *MIC850*)
- MIC850 ignition controller
- Up to 2 VariStep or VariStep3 stepper motor drivers (selection: *VariStep*)

You can have device-specific views displayed according to your selection on the ALL-IN-ONE.NT, ALL-IN-ONE.Vision 5 and ALL-IN-ONE.Vision 8 displays.

When using an ECU with MIC ignition controller, you also need a password from your MOTORTECH contact person to be able to establish the connection to the ECU devices. For more information, read the section *Setting ECU List for MOTORTECH® Devices* on page 60.

The MOTORTECH ECU list is not installed together with the ComAp PC Suite. You can get information on installing the MOTORTECH ECU list in the section *ComAp PC Suite* on page 52.

6.20 VDE-AR-N 4105 Application Guide

It is possible to use the ALL-IN-ONE.NT in conformity with the VDE-AR-N Application Guide if the IS-NT-AFR 2.2 firmware is installed on the ALL-IN-ONE.NT and a VDE archive is used (see *Overview: AFR Archives* on page 57). Note that certain parameters (*setpoints*) of the ALL-IN-ONE.NT must be preset to specific values and are to be locked to prevent changes.

More information is found in the following documents, which must be observed without fail:

- IGS-NT Safety Manual from ComAp
- IS-NT-AFR 2.3.1 New Features from ComAp

Both documents are contained on the supplied storage device.

6.21 BDEW Medium Voltage Guideline

If your generating plant needs to be certified as per the BDEW Medium Voltage Guideline, use the appropriate VDE archive for your application in connection with the firmware IS-NT-AFR 2.3.1. The 2.3.0 VDE archives contain extensions which assist you with adapting your generating plant to the requirements of the BDEW Medium Voltage Guideline (see *Overview: AFR Archives* on page 57).

More information is found in the following documents, which must be observed without fail:

- BDEW Manual for ComAp Controllers in Parallel Operation from ComAp
- IS-NT-AFR 2.3.1 New Features from ComAp

Both documents are located on the supplied storage device.

7 COMAP PC SUITE

Using the ComAp PC Suite, you can install all programs and data you need for configuring, monitoring, controlling, and updating the ALL-IN-ONE.NT generator & CHP control system and its additional modules on your computer.

The ComAp PC Suite encompasses the following programs and data depending on the respective software release:

- IntelliMonitor monitoring and control software including the PLC monitor application
- Configuration software GenConfig including standard ECU lists
- Additional utilities (for example WinScope, IBCConfig)
- Device firmware including the corresponding archives
- Any necessary drivers and runtime environments

Information on the installation of the ComAp PC Suite can be found in the following sections.

7.1 ComAp PC Suite System Requirements

The ComAp PC Suite including the IntelliMonitor, GenConfig, and WinScope applications can generally be installed and operated on computers with the following Windows® operating systems:

- Microsoft® Windows® 2000
- Microsoft® Windows® XP
- Microsoft® Windows Vista®
- Microsoft® Windows® 7
- Microsoft® Windows® 8

Also note the system requirements of the respective applications and utilities. For more information, please refer to the documentation of the respective software.

7.2 ComAp PC Suite Installation

The software for the installation of the ComAp PC Suite is on the storage device (USB flash drive or CD-ROM) enclosed with the ALL-IN-ONE.NT generator & CHP control system.

1. Start the installation:
 - Via the menu:
Start the file *Start.exe* on the storage device. Call up the installation routine of the ComAp PC Suite via *Software -> ComAp PC Suite -> Install ComAp PC Suite*.
 - Directly from the storage device:
Run the installation routine of the ComAp PC Suite directly. It is on the storage device in the *Installation* sub-directory and is named as follows, for example:
IGS-NT-Install-Suite-3.3.o.2.exe
2. Run the installation.
Follow the instructions of the installation routine and note that the ComAp PC Suite license agreement terms must be accepted.
3. Install the desired firmware including the associated archives on your computer via the menu or directly from the storage device.
 - via the menu:
Firmware > IS-NT-AFR x.x.x (2.3.1 or 2.2) -> Install IS-NT-AFR x.x.x
 - Directly from the storage device:
Run the *icg* file in the *Archive/IS-NT-AFR_x.x.x* (e. g. *Archive/IS-NT-AFR_2.3.1*) sub-directory by double-clicking on it (e. g. *IS-NT-AFR-2.3.1.icg*)
4. Follow the instructions of the installation routine. Select the *Overwrite older files only* option in the *ComAp Firmware Import* window.
5. Install the MOTORTECH ECU list via the menu or directly from the storage device as well:
 - via the menu:
Software > ECU list MOTORTECH -> Install ECU list MOTORTECH
 - Directly from the storage device:
Run the *icg* file in the *Installation* sub-directory by double-clicking on it (e. g. *ECU list - Motortech-1.1.icg*)
6. Install the program.
Follow the instructions of the installation routine. Select the *Overwrite older files only* option in the *ComAp Firmware Import* window.

8 SETTINGS VIA GENCONFIG



Operational safety!

All parameters are set to their typical values at the factory. However, the parameters of the *Basic settings* group must be adjusted before starting the gen-set for the first time. If the basic setting parameters are incorrectly set, this may cause irreparable damage to the gen-set.



Operational safety!

Note that the states of the binary outputs can change during and after the configuration of the device software. Before you put the generator & CHP control system back into operation, make absolutely sure that the configuration and parameter settings match your system.

The ALL-IN-ONE.NT generator & CHP control system needs information about the connected devices and the gen-set in order to interpret the incoming signals correctly and to output the desired control and status signals. This information is stored in the configuration of the generator & CHP control system.

You need GenConfig for the following tasks:

- Uploading configuration from an ALL-IN-ONE.NT generator & CHP control system
- Downloading configuration to an ALL-IN-ONE.NT generator & CHP control system
- Opening configuration from a storage device
- Saving configuration on a storage device
- Editing configurations
- Updating ALL-IN-ONE.NT generator & CHP control system firmware
- Editing user interface of the ALL-IN-ONE.Vision 5 and the ALL-IN-ONE.Vision 8
- Programming PLC functions

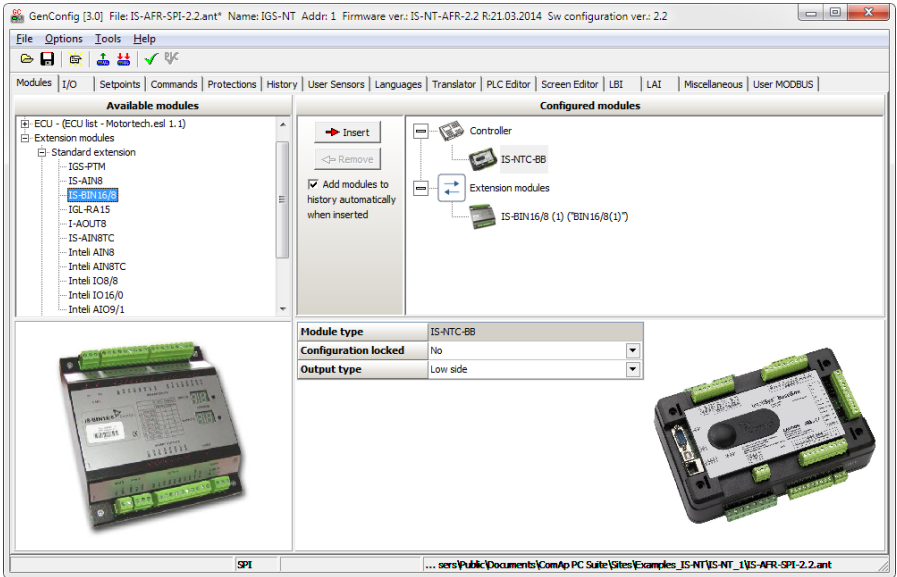

You install GenConfig via the ComAp PC Suite (see *ComAp PC Suite* on page 52). You can find more information on working with GenConfig in the GenConfig 3.0 Reference Guide from ComAp.

8 SETTINGS VIA GENCONFIG

8.1 Available Memory Space

196 kB of memory space is reserved in the ALL-IN-ONE.NT for the configuration. For example, you can use it for module configuration as follows:

Archives without MIC support	Archives with MIC support
10x IS-AIN8	10x IS-AIN8
6x IS-BIN16/8	6x IS-BIN16/8
VPIO module	VPIO module
5 languages	4 languages
126 values (history)	126 values (history)
	MIC850
	2x VariStep

The set-up above does not take into account PLC functions.

If there is not enough memory space for module configuration in the ALL-IN-ONE.NT, you get the following error message when uploading the configuration:

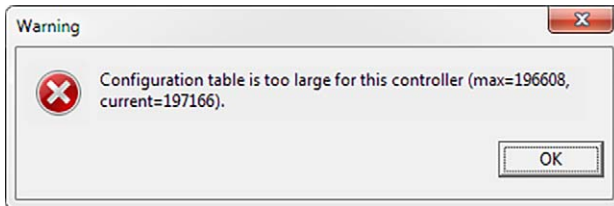

In this case, you have to reduce the size of the configuration, for example by removing languages you do not need.

8.2 Overview: AFR Archives

The following firmware versions are available for the ALL-IN-ONE.NT generator & CHP control system:

- IS-NT-AFR 2.2
- IS-NT-AFR 2.3.1

Both firmware versions are based on IGS firmware IGS-NT-3.0. Note that in individual cases, certain functions of the IGS firmware are not available in the IS-NT-AFR firmware.

For standard applications, use the firmware IS-NT-AFR 2.2. You can use the following archives with this firmware:

- IS-AFR-SPI-2.2.ant
- IS-AFR-MIC-SPI-2.2.ant
- IS-AFR-SPTM-2.2.ant
- IS-AFR-MIC-SPTM-2.2.ant
- IS-AFR-MINT-2.2.ant
- IS-AFR-MIC-MINT-2.2
- IS-AFR-Combi-2.2.ant
- IS-AFR-VDE-SPI-2.2.ant*
- IS-AFR-MIC-VDE-SPI-2.2.ant*
- IS-AFR-VDE-SPTM-2.2.ant*
- IS-AFR-MIC-VDE-SPTM-2.2.ant*

*It is possible to use the ALL-IN-ONE.NT in conformity with the VDE-AR-N 4105 Application Guide if the firmware IS-NT-AFR 2.2 is installed on the ALL-IN-ONE.NT and a VDE archive is used.

If your generating plant is to be certified in accordance with the BDEW Medium Voltage Guideline, we recommend using the firmware IS-NT-AFR 2.3.1. Your archives contain extensions which will assist you when configuring your generating plant so that it is in line with the requirements of the BDEW Medium Voltage Guideline. However, the archives are not certified for the VDE-AR-N 4105 Application Guide:

- IS-AFR-VDE-SPI-2.3.0.ant
- IS-AFR-MIC-VDE-SPI-2.3.0.ant
- IS-AFR-VDE-SPTM-2.3.0.ant
- IS-AFR-MIC-VDE-SPTM-2.3.0.ant

8 SETTINGS VIA GENCONFIG

The abbreviations in the archive designations have the following meanings:

Abbr.	Meaning
AFR	Archive including the extended functions of the ALL-IN-ONE generator & CHP control systems
Combi	Archive for combined SPI, SPTM and MINT applications
MIC	Archive with which MOTORTECH ignition controllers of the new generation and up to two VariStep/VariStep3 can be integrated as ECUs. Requires loaded ECU list <i>ECU list - Motortech.esl</i> (see <i>Operation with MOTORTECH® Devices</i> on page 50)
MINT	Archive for MINT applications
SPI	Archive for SPI applications
SPTM	Archive for SPTM applications
VDE	Customized archive for the VDE-AR-N 4105 Application Guide and the BDEW Medium Voltage Guideline

The provided archives include default settings for module configuration and parameters (*setpoints*). Adjust these to the respective system before putting the system into operation.

For further general information on archive files, read the section *Archive versus Configuration* in the GenConfig 3.0 Reference Guide from ComAp.

8.3 Setting Program Mode

GenConfig can be operated in two program modes:

- **Basic**

In *Basic* program mode, a simplified user interface with fewer setting options is available. Use this mode when you only need the basic functions of the ALL-IN-ONE.NT generator & CHP control system.

- **Advanced**

In *Advanced* program mode, all functions and setting options of the user interface are available. Use this mode when you need all functions of the ALL-IN-ONE.NT generator & CHP control system.

You can change the program mode of GenConfig using the *Settings* window. Proceed as follows:

1. Open the *Settings* window via: *Main view -> Options -> Settings*

- ▶ The following window appears:

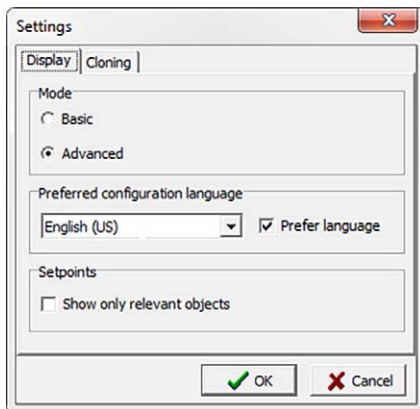

2. On the *Display* tab, select the desired program mode under *Mode*.
3. Confirm your selection with *OK*.

8 SETTINGS VIA GENCONFIG

8.4 Setting ECU List for MOTORTECH® Devices

If you have set *ECU list - Motortech.esl* as ECU list in the GenConfig configuration software, you can add the following MOTORTECH devices to the module configuration if an MIC archive is selected, provided these devices are connected to the ALL-IN-ONE.NT via the CAN bus:

- MIC3/4/5 ignition controller (selection: *MIC850*)
- MIC850 ignition controller
- Up to 2 VariStep or VariStep3 stepper motor drivers (selection: *VariStep*)

In order to select the MOTORTECH ECU list in GenConfig, it must be installed on your computer (see *ComAp PC Suite* on page 52). If this is the case, you can select the MOTORTECH ECU list via the entry *ECU list - Motortech.esl* under *Options* -> *ESL files* in the GenConfig configuration software.

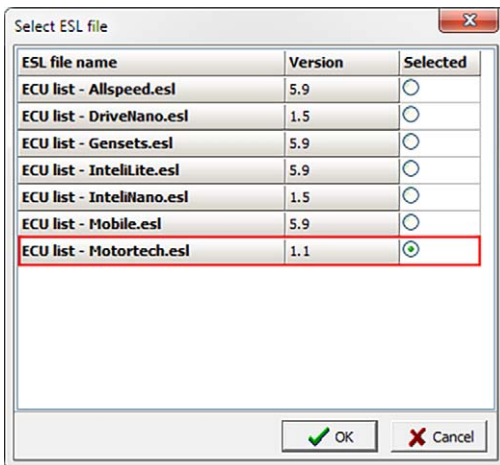

When using an ECU with MIC ignition controller, you also need a password from your MOTORTECH contact person (see *Customer Service Information* on page 110) to establish the connection to the ECU devices. Enter the password under *ProcessControl: MIC Enable* to establish the connection.

You can find more information on using the ECU lists in the section *ECU List* in the GenConfig 3.0 Reference Guide from ComAp.

8.5 Modules – DetCon20

Provided you add the *DetCon20* extension module to the module configuration in the GenConfig configuration software, you can use the *Number of used sensors* parameter to set how many knocking sensors are connected to the DetCon20.

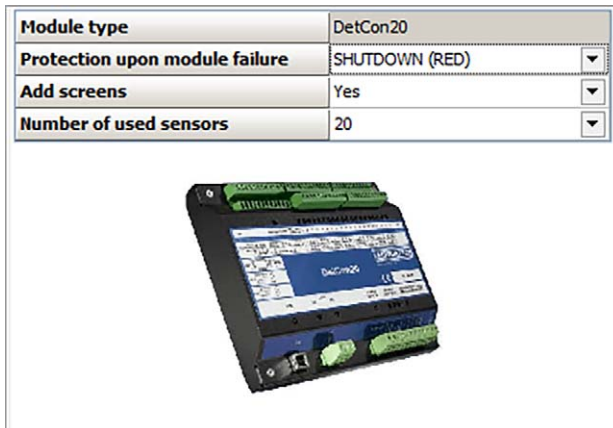

Correspondingly, GenConfig adapts the display of the knock intensities for the ALL-IN-ONE.NT, ALL-IN-ONE.Vision 5 and ALL-IN-ONE.Vision 8 displays.

You can find more information on module configuration in GenConfig in the section *Modules* in the GenConfig 3.0 Reference Guide from ComAp.

8.6 Additional Logical Binary Inputs (LBI)

The following section describes the additional logical binary inputs which can be assigned to physical and virtual binary inputs when an AFR archive is selected.

For a description of additional logical binary inputs, read the section *Binary input functions* in the IGS-NT-3.0 Reference Guide from ComAp for your selected archive. The ALL-IN-ONE.NT generator & CHP control system corresponds to the generator & CHP control system IS-NT-BB.

- **Gas Selection**
Serves to switch between the mixer position sets. When the input is open, the generator & CHP control system uses position set 1, when the input is closed, position set 2.
- **MisFiring**
Informs the generator & CHP control system that misfiring is occurring in the engine. When the input is closed, the generator & CHP control system initiates measures to prevent misfiring and protect the engine. For more information, read the section *Misfire Protection* on page 45.

8 SETTINGS VIA GENCONFIG

- **DxLoad reduct**
Informs the generator & CHP control system that the combustion is knocking in the engine. When the input is closed, the generator & CHP control system initiates measures to prevent knocking and protect the engine. Read the section *Detonation Control* on page 46 for more information.
- **GasVTest OK**
A closed input informs the generator & CHP control system that the gas supply of the connected test unit has been successfully tested for leaks. For more information, read the section *Gas Ventilation Test Before Engine Start* on page 35.
- **SyncDisabled**
If this input is closed, forward and reverse synchronization are deactivated in the generator & CHP control system. Ongoing synchronization is also immediately canceled.
- **GCB feedback S**
An additional input for a second generator circuit breaker is available in the AFR archives for SPI and SPTM applications. This is intended for applications in which synchronization is performed via two generator circuit breakers connected in series. The function corresponds to the *GCB feedback* input (see section *Binary input: GCB feedback* in the respective IGS-NT-3.0 Reference Guide from ComAp).

8.7 Additional Logical Binary Outputs (LBO)

The following section describes the additional logical binary outputs which can be assigned to physical and virtual binary outputs when an AFR archive is selected.

For a description of additional logical binary outputs, read the section *Binary output functions* in the IGS-NT-3.0 Reference Guide from ComAp for your selected archive. The ALL-IN-ONE.NT generator & CHP control system corresponds to the generator & CHP control system IS-NT-BB.

- **GasVTest run**
The generator & CHP control system switches this output when the gas ventilation test function is active in order to start the gas ventilation test for the connected test unit. For more information, read the section *Gas Ventilation Test Before Engine Start* on page 35.
- **kWh pulses**
Output for pulse counting of energy generated by the gen-set. The generator & CHP control system repeatedly issues a one-second pulse through this output any time the gen-set has generated as much energy as is set in the *AFR control: kWh pulse* parameter.
- **Wrn Stop fail**
The generator & CHP control system switches this output when speed is still registered in the case of an engine stop after expiration of the *stop time*. In the ALL-IN-ONE firmware, the *Wrn Stop fail* binary output replaces the *Sd Stop fail* binary output of the IGS firmware.
- **MAP ctrl fail**
The output is switched when the maximum permissible deviation from the manifold pressure target value (*AFR control: MAP difference*) is exceeded for the maximum permissible time span (*AFR control: MAP timeout*).

- **Mixer up**
The generator & CHP control system switches this output in order to give the control of the first air/gas mixer a binary control signal in the open direction.
- **Mixer down**
The generator & CHP control system switches this output in order to give the control of the first air/gas mixer a binary control signal in the closed direction.
- **OFF coil test**
When an AFR archive is selected, this output is available for SPI applications and signals with a two-second pulse that a mains protection has been triggered due to impermissible mains parameters. For more information, read the section *Signaling Active Mains Protections* on page 49.
- **GCBclose/openS, GCB ON coil S, GCB OFF coil S, GCB UV coil S**
These outputs are also available in archives for SPI and SPtM applications so that the ALL-IN-ONE.NT can control the second generator circuit breaker. The function corresponds to the *GCB close/open*, *GCB ON coil*, *GCB OFF coil* and *GCB UV coil* binary outputs. For a description of these binary outputs, read the sections in the respective IGS-NT-3.0 Reference Guide from ComAp for your selected archive.
- **Service Time 1 / 2 / 3 / 4**
The generator & CHP control system switches the output as soon as the respective service timer has counted to zero.
- **Mixer up 2**
The generator & CHP control system switches this output in order to give the control of the second air/gas mixer a binary control signal in the open direction.
- **Mixer down 2**
The generator & CHP control system switches this output in order to give the control of the second air/gas mixer a binary control signal in the closed direction.
- **MAPControlFls**
This output is closed when the input for the manifold pressure (MAP) or the input for the manifold air temperature (MAT) is not configured or at least one of the two connected sensors has failed.
- **Stp O₂ limit**
This logical binary output does not have a function.
- **Sd MAPCtrlFail**
The generator & CHP control system switches this output when the maximum permissible deviation from the manifold pressure target value (*AFR control: MAP difference*) is exceeded for the maximum permissible time span (*AFR control: MAP timeout*).
- **Wrn Misfire**
The generator & CHP control system switches this output as soon as the *MisFiring* binary input is switched.
- **Sd Misfire**
The generator & CHP control system switches this output when it has initiated measures against misfiring six times within an hour (See *Misfire Protection* on page 45).

8 SETTINGS VIA GENCONFIG

- **Stp MisfireTO**
The generator & CHP control system switches this output when the *AFR control: Misfiring del* time span has expired.
- **Sd KnockingTO**
The generator & CHP control system switches this output when the *AFR control: Knocking del* time span has expired.
- **Sd Knocking**
The generator & CHP control system switches this output when it has initiated measures against knocking combustion six times within an hour (see *Detonation Control* on page 46).
- **Sd GasVTest**
The output is switched when the generator & CHP control system does not start the engine due to a negative result of the gas ventilation test.
- **Sd GasVTestFdb**
The *GasVTest OK* binary input can remain switched in all gen-set states. However, it must be open when the ALL-IN-ONE.NT initiates the gas ventilation test. Otherwise it does not start the engine and switches this binary output.

8.8 Additional Logical Analog Inputs (LAI)

The following section describes the additional logical analog inputs which can be assigned to physical and virtual analog inputs when an AFR archive is selected.

For a description of the additional logical analog inputs, read the section *Analog input functions* in the IGS-NT-3.0 Reference Guide from ComAp for your selected archive. The ALL-IN-ONE.NT generator & CHP control system corresponds to the generator & CHP control system IS-NT-BB.

- **MAP**
Analog input for the measured value signal of the manifold pressure sensor in the first manifold. The sensor characteristic configured under *User sensors* in GenConfig should have a resolution of at least 0.001 bar. If measured value signals are incorrect, the generator & CHP control system initiates a shutdown of the engine.
- **MAP₂**
Analog input for the measured value signal of the manifold pressure sensor in the second manifold. Both manifold pressure sensor inputs (*MAP* and *MAP₂*) have to be configured with the same resolution and the same signal range.
- **MAT**
Analog input for the measured value signal of the manifold air temperature sensor. If measured value signals are incorrect, the generator & CHP control system initiates a shutdown of the engine.
- **Ana CH₄**
Analog input for the measured value signal of a methane sensor.
- **UEGO**
This analog input is not supported by the generator & CHP control system.

- **Mixer fdb**
Analog input for feedback of the mixer position from the first air/gas mixer. With analog mixer control, *Mixer fdb* must cover the same position range as the *Mixer position* output (usually 0 to 100 %). With binary mixer control, *Mixer fdb* must cover the entire controllable position range (usually 0 to 100 %).
- **Mixer fdb2**
Analog input for the feedback of the mixer position from the second air/gas mixer. *Mixer fdb2* must cover the same position range as *Mixer fdb* (usually 0 to 100 %).

8.9 Setpoints – ProcessControl

The following additional parameters are available in the *ProcessControl* group when an AFR archive MIC is selected:

- **MIC Enable**
When using an ECU with MIC ignition controller, enter the password you received from your MOTORTECH contact person (see *Customer Service Information* on page 110) to activate the connection to the ECU device.

For a description of the parameters of the *ProcessControl* group which are also available in the IGS firmware, read the section *Setpoints – Process Control* in the IGS-NT-3.0 Reference Guide from ComAp for your selected archive. The ALL-IN-ONE.NT generator & CHP control system corresponds to the generator & CHP control system IS-NT-BB.

8.10 Setpoints – Basic Settings

The following additional parameter is available upon selection of an AFR archive in the *Basic settings* group:

- **LoadFilterDeg**
When active power measured values fluctuate, set the strength with which the active power measured values are to be filtered. Note that the phase of the measured signal shifts slightly when the filter is active, which can in rare cases lead to inaccuracy in the PID control of the mixture control.

For a description of the parameters of the *Basic settings* group which are also available in the IGS firmware, read the section *Setpoints – Basic Settings* in the IGS-NT-3.0 Reference Guide from ComAp for your selected archive. The ALL-IN-ONE.NT generator & CHP control system corresponds to the generator & CHP control system IS-NT-BB.

8 SETTINGS VIA GENCONFIG

8.11 Setpoints – Comms Settings

The following additional parameters are available in the *Comms settings* group when an AFR archive is selected:

- **ForceVal log**
Use this parameter to determine whether the activation and deactivation of force values should be recorded in the history.

For a description of all other parameters, read the section *Setpoints – Comms settings* in the IGS-NT-3.0 Reference Guide from ComAp for your selected archive. The ALL-IN-ONE.NT generator & CHP control system corresponds to the generator & CHP control system IS-NT-BB.

8.12 Setpoints – Engine Protect

The following section describes the additional parameters in the *Engine protect* group when an AFR archive is selected.

For a description of additional parameters, read the section *Setpoints – Engine Protect* in the IGS-NT-3.0 Reference Guide from ComAp for your selected archive. The ALL-IN-ONE.NT generator & CHP control system corresponds to the generator & CHP control system IS-NT-BB.

- **StartOverspeed**
Threshold for the maximum permissible speed at the time of engine start. Since the *Overspeed* standard threshold is also tested at the time of engine start, this parameter only takes effect if it is lower than the overspeed threshold.
- **StartBlockDel**
After an engine stop, a renewed engine start is disabled for the set time span.
- **ServiceTimeSd**
After expiration of the set number of hours, the generator & CHP control system stops the engine.
- **BoOvrSpdReset**
This parameter is used to set the behavior of the ALL-IN-ONE.NT in the *AUT* operation mode when it has opened the generator circuit breaker in the context of off load protection and registered overspeed after opening. You can make the following settings:
 - **YES:** The overspeed alarm is automatically reset internally. As soon as the respective alarms which led to the triggering of the off load protection are no longer present, the ALL-IN-ONE.NT restarts the gen-set.
 - **NO:** The overspeed alarm is not automatically reset internally.

8.13 Setpoints – Mains Protect

The following section describes the additional parameters in the *Mains protect* group when an AFR archive is selected for SPI, SPTM or Combi applications.

For a description of additional parameters, read the section *Setpoints – Mains protect* in the IGS-NT-3.0 Reference Guide from ComAp for your selected archive. The ALL-IN-ONE.NT generator & CHP control system corresponds to the generator & CHP control system IS-NT-BB.

- **Mains >V del**
Time span which the threshold for mains overvoltage *Mains >V MP* must have exceeded before the generator & CHP control system unloads the gen-set as a protective measure and, depending on the application, opens the generator circuit breaker or the mains circuit breaker. This entry replaces the *Mains V del* entry of the IGS firmware.
- **Mains <V del**
Time span which the threshold for mains undervoltage *Mains <V MP* must have exceeded before the generator & CHP control system unloads the gen-set as a protective measure and, depending on the application, opens the generator circuit breaker or the mains circuit breaker. This entry replaces the *Mains V del* entry of the IGS firmware.
- **Mains >>V MP**
Second threshold for mains overvoltage. If this threshold is exceeded, the generator & CHP control system opens, depending on the application, the generator circuit breaker or the mains circuit breaker as a protective measure without unloading the gen-set.
- **Mains >>V del**
Time span which the second threshold for mains overvoltage *Mains >>V MP* must have exceeded before the generator & CHP control system opens the generator circuit breaker or the mains circuit breaker.
- **Mains <<V MP**
Second threshold for mains undervoltage. If this threshold is exceeded, the generator & CHP control system opens, depending on the application, the generator circuit breaker or the mains circuit breaker as a protective measure without unloading the gen-set.
- **Mains <<V del**
Time span which the second threshold for mains undervoltage *Mains <<V MP* must have exceeded before the generator & CHP control system opens the generator circuit breaker or the mains circuit breaker.
- **Mains Avg>V MP**
The generator & CHP control system calculates an average from the phase voltages of the last 10 minutes. The *Mains Avg>V MP* parameter is used to set the maximum threshold that this average may exceed. More information on this parameter can be found in the section *Additional Test Parameters for Mains Voltage* on page 37.
- **Mains >f Del**
Time span which the threshold for mains overfrequency *Mains >f* must have exceeded before the generator & CHP control system unloads the gen-set as a protective measure and, depending on the application, opens the generator circuit breaker or the mains circuit breaker. This entry replaces the *Mains f del* entry of the IGS firmware.

8 SETTINGS VIA GENCONFIG

- **Mains <f Del**
Time span which the threshold for mains underfrequency *Mains <f* must have exceeded before the generator & CHP control system unloads the gen-set as a protective measure and, depending on the application, opens the generator circuit breaker or the mains circuit breaker. This entry replaces the *Mains f del* entry of the IGS firmware.

The following parameters are not available when an AFR archive VDE is selected in the *Mains protect* group:

- **FwRet break >U**
Time span after a mains overvoltage alarm which the generator & CHP control system must ensure upon return of the mains that the mains parameters are stable before it initiates reverse synchronization.
- **FwRet break <U**
Time span after a mains undervoltage alarm which the generator & CHP control system must ensure upon return of the mains that the mains parameters are stable before it initiates reverse synchronization.
- **FwRet break >f**
Time span after a mains overfrequency alarm which the generator & CHP control system must ensure upon return of the mains that the mains parameters are stable before it initiates reverse synchronization.
- **FwRet break <f**
Time span after a mains underfrequency alarm which the generator & CHP control system must ensure upon return of the mains that the mains parameters are stable before it initiates reverse synchronization.
- **FwRet break VS**
Time span after a vector shift alarm which the generator & CHP control system must ensure upon return of the mains that the mains parameters are stable before it initiates reverse synchronization.
- **AfMainsFIRun**
Maximum time which the generator & CHP control system waits after off load due to a mains alarm for return of the mains before it switches off the gen-set. During this time, it lets the gen-set run idle. As soon as the mains is available after switch-off, the gen-set restarts. This parameter influences the behavior of the ALL-IN-ONE.NT in the *AUT* operation mode.

8.14 Setpoints – Sync/Load Ctrl

The following additional parameter is available when an AFR archive is selected in the *Sync/Load ctrl* group:

- **Sync attempts**
Specify the maximum number of synchronization attempts before the ALL-IN-ONE.NT initiates a slow stop of the engine.

The following parameters are also available when an AFR archive VDE is selected in the *Sync/Load ctrl* group:

- **MainsSyncVMax**
Maximum permissible mains voltage for reconnection to mains
- **MainsSyncVMin**
Minimum permissible mains voltage for reconnection to mains
- **MainsSyncFMax**
Maximum permissible mains frequency for reconnection to mains
- **MainsSyncFMin**
Minimum permissible mains frequency for reconnection to mains
- **MainsSyncTShrt**
Minimum time span for which the mains frequency and voltage must be within the aforementioned limits in order to initiate reconnection to the mains after a mains failure of less than 3 seconds.
- **MainsSyncTLong**
Minimum time span for which the mains frequency and voltage must be within the aforementioned limits in order to initiate reconnection to the mains after a mains failure of more than 3 seconds.

For a description of additional parameters, read the section *Setpoints – Sync/Load Ctrl* in the IGS-NT-3.0 Reference Guide from ComAp for your selected archive. The ALL-IN-ONE.NT generator & CHP control system corresponds to the generator & CHP control system IS-NT-BB.

8.15 Setpoints – Act. calls/SMS

If an AFR archive is selected, it is possible to activate and deactivate the *AcallCHx-Type* parameters via the *Force Value* function. This way, for example, you can control at which times the configured recipients are to receive alarm messages. You can configure up to three recipients.

For a description of the parameters in the *Act. calls/SMS* group, read the section *Setpoints – Act. calls/SMS* in the IGS-NT-3.0 Reference Guide from ComAp for your selected archive. The ALL-IN-ONE.NT generator & CHP control system corresponds to the generator & CHP control system IS-NT-BB.

8 SETTINGS VIA GENCONFIG

8.16 Setpoints – AFR Control

The *AFR control* group is available in addition to other groups when using an AFR archive. You can set the following parameters in this group:

- **GasVTest**
Activates or deactivates the gas ventilation test before engine start. If the function is activated, the generator & CHP control system checks the gas supply for leaks each time before the engine is started.
- **Second Mixer**
Activates or deactivates the control of a second air/gas mixer by the generator & CHP control system.
- **GasVTest del**
Maximum test duration of the gas ventilation test. If the generator & CHP control system does not get a positive test result sent back from the test unit during this time span, it does not start the engine.
- **StartPosition1**
Mixer position at the time of engine start for the first mixer position set
- **StartP Offset1**
The start position of the first mixer position set is shifted by the offset set here after repeated false starts and before the last start attempt.
- **RunPosition1**
Mixer position during running without load for the first mixer position set
- **LoPwrPosition1**
Mixer position during running with load and a gen-set power below the power-dependent control range for the first mixer position set
- **StartPosition2**
Mixer position at the time of engine start for the second mixer position set
- **StartP Offset2**
The start position of the second mixer position set is shifted by the offset set here after repeated false starts and before the last start attempt.
- **RunPosition2**
Mixer position during running without load for the second mixer position set
- **LoPwrPosition2**
Mixer position during running with load and a gen-set power below the power-dependent control range for the second mixer position set
- **MxPos40%CH₄**
Reference mixer position at a methane content of 40 % of the methane content characteristic
- **MxPos60%CH₄**
Reference mixer position at a methane content of 60 % of the methane content characteristic

- **Ana CH₄**
Set the mode for adjusting the fixed mixer positions depending on the methane content of the inflowing gas. The following modes are available:
 - **DISABLED:** The adjustment of the fixed mixer positions depending on the methane content is switched off. The ALL-IN-ONE.NT drives to the fixed mixer positions as configured.
 - **ENA-FIX:** The ALL-IN-ONE.NT determines the fixed mixer positions using the characteristic line for methane content adjustment. The configured positions are not taken into account.
 - **ENA-STEP:** The ALL-IN-ONE.NT determines the fixed mixer positions using the characteristic line for methane content adjustment. The ALL-IN-ONE.NT shifts the run position and the low power position based on the configured difference to the fixed start position.

- **Mixer MODE**
Enter the desired mixture control mode. The following modes are available:
 - **MANUAL:** The current mixer position of both air/gas mixers is set via the *Mixer position* parameter.
 - **AUTOMATIC:** The ALL-IN-ONE.NT drives to the fixed mixer positions depending on the gen-set states. During running with load while in the power-dependent control range, the mixer position is set according to the manifold pressure characteristic. The mixer position control based on manifold pressure is provided independently for both air/gas mixers.
 - **AUT-PAR:** The *AUT-PAR* mode corresponds to the *AUTOMATIC* mixture control mode. However, the mixer position is only set according to the manifold pressure characteristic if the gen-set is running in parallel operation and the load is in the power-dependent control range.

- **Mixer position**
Mixer position which is to be approached by the two air/gas mixers in *MANUAL* mixture control mode.
- **MAP₁ power**
Engine power of the first point of the characteristic at which the manifold pressure target value *MAP₁* is to be produced.
- **MAP₁**
Manifold pressure target value of the first point of the characteristic for the engine power defined in the parameter *MAP₁ power*.
- **MAP₂ power**
Engine power of the second point of the characteristic at which the manifold pressure target value *MAP₂* is to be produced.
- **MAP₂**
Manifold pressure target value of the second point of the characteristic for the engine power defined in the parameter *MAP₂ power*.

8 SETTINGS VIA GENCONFIG

- **MAP₃ power**
Engine power of the third point of the characteristic at which the manifold pressure target value *MAP₃* is to be produced.
- **MAP₃**
Manifold pressure target value of the third point of the characteristic for the engine power defined in the parameter *MAP₃ power*.
- **MAP₄ power**
Engine power of the fourth point of the characteristic at which the manifold pressure target value *MAP₄* is to be produced.
- **MAP₄**
Manifold pressure target value of the fourth point of the characteristic for the engine power defined in the parameter *MAP₄ power*.
- **MAP₅ power**
Engine power of the fifth point of the characteristic at which the manifold pressure target value *MAP₅* is to be produced.
- **MAP₅**
Manifold pressure target value of the fifth point of the characteristic for the engine power defined in the parameter *MAP₅ power*.
- **MAT reference**
Reference temperature of the manifold pressure characteristic
- **MAT correction**
Correction factor for the manifold pressure target value in the event of deviations from the reference temperature. The entry refers to a deviation of 1 °C. At temperatures in the manifold above the reference temperature, *MAT correction* is added proportionally to the manifold pressure target value, in the case of temperatures in the manifold below the reference temperature, *MAT correction* is subtracted proportionally from the manifold pressure target value.
- **MAPcorrLimit**
Maximum value by which the manifold pressure target value can be positively and negatively corrected in the event of deviations from the reference temperature.



Configuration of the manifold pressure characteristic

Observe the following conditions when configuring the manifold pressure characteristic of the ALL-IN-ONE.NT:

- The manifold pressure characteristic must consist of at least two setpoints, i.e. at least *MAP₁*, *MAP₁ power*, *MAP₂* and *MAP₂ power* must be defined.
- The manifold pressure characteristic must cover the range from the first setpoint through to nominal power.
- The values for *MAP_x power* must rise from one setpoint to the next.
- The characteristic must always begin with *MAP₁* and *MAP₁ power*.
- Set the respective *MAP_x* parameters to *OFF* for setpoints which you are not using. As soon as a *MAP_x* parameter is set to *OFF*, all following setpoints are ignored. Therefore, you cannot skip any setpoints.

Example

You would like to define a manifold pressure characteristic with three setpoints.

Solution:

1. Define the *MAP₁* to *MAP₃* and *MAP₁ power* to *MAP₃ power* parameters in ascending order.
2. Set the *MAP₄* parameter to *OFF*.

- **Low O₂, High O₂, Diff O₂, Diff O₂ del**
The function which these relate to is not available.
- **Mixer BO hyst**
Maximum difference of the mixer's opening angle in percent which may exist between the targeted mixer position and the position reported back via the *Mixer fdb* or *Mixer fdb2* input.
- **AFR gain**
Reinforcement of the control loop of the power-dependent air/fuel mixture control
- **AFR int**
Integration factor of the control loop of the power-dependent air/fuel mixture control
- **AFR der**
Deviation factor of the control loop of the power-dependent air/fuel mixture control
- **MisfMAP reduct**
If misfiring is signaled via the closed *MisFiring* binary input, the calculated manifold pressure target value is corrected with the set *MisfMAP reduct* value. Positive parameter values increase the manifold pressure target value, negative values decrease it.

8 SETTINGS VIA GENCONFIG

- **MisfLdRed del**
If misfiring is signaled via the closed *MisFiring* binary input, the generator & CHP control system unloads the gen-set after expiration of the *MisfLdRed del* time span to the set minimum power for parallel operation (*Gener protect: Min power PtM*).
- **Misfiring del**
If misfiring is signaled via the closed *MisFiring* binary input, the generator & CHP control system initiates a slow stop of the engine after expiration of the *Misfiring del* time span.
- **Knocking del**
If knocking combustion is signaled via the closed *DxLoad reduct* input, the generator & CHP control system initiates a shutdown of the engine after expiration of the *Knocking del* time span.
- **MAP difference**
Maximum value by which the actual manifold pressure may deviate from the calculated target value positively or negatively.
- **MAP timeout**
Maximum period in seconds that the maximum deviation from the manifold pressure target value (*MAP difference*) may be exceeded.
- **kWh pulse**
Amount of energy generated by the gen-set after which the generator & CHP control system outputs a one-second long counting pulse at the *kWh pulses* binary output. Impulse counting is restarted as soon as the parameter is changed.

8.17 Setpoints – I-Step

The *I-Step* group is available if you include the *I-Step* module in the module configuration when an AFR archive is selected. The configuration of the parameters in this group via GenConfig corresponds to the configuration via WinScope as described in the reference guide of the I-Step stepper motor driver. For more information on the configuration of the I-Step stepper motor driver, read the I-Step Reference Guide from ComAp.

8.18 Setpoints – ECON₄-EngRPM

The *ECON₄-EngRPM* group is available if you include the ECON-₄ module in the module configuration when an AFR archive is selected. You also use the ECON-₄ module for the MOTORTECH SC100 electronic speed controller. In this group, you can set the following parameters of the ECON-₄ or SC100 speed controller:

- **Idle RPM**
Engine idle speed. Make sure that the idle speed of the engine is set lower than the nominal speed of the engine but higher than the speed threshold for engine start (*ECON₄-EngStart: Starting RPM*).
- **Nominal RPM**
Nominal speed of the engine
- **Overspeed**
Determines the maximum permissible speed of the engine. If it is exceeded by the engine, the speed controller closes the actuator. As soon as the speed controller registers an idle state, it can be operated normally again.
- **Idle-Nom ramp**
This parameter is used to define the time span which the speed controller requires for changing the idle speed to the nominal speed and vice versa.
- **BI Speed ramp**
This parameter is used to define the time span which the speed controller requires for changing from -8 % to +8 % of the nominal speed and vice versa. Changes to the speed via the *SPEED UP* and *SPEED DOWN* binary inputs are made by the speed controller in a ratio corresponding to the time span set here.
- **Speed request**
This parameter is used to determine which source can be used to change the speed controller bias:
 - **BIN**: Via the *SPEED UP* and *SPEED DOWN* binary inputs of the speed controller
 - **ANA**: Via the *SPEED REQUEST* analog input of the speed controller
 - **DATA**: Via the CAN bus
- **Gear teeth**
Number of teeth needed on the flywheel of the engine so that the speed controller can correctly determine the engine speed with the pickup. Input the actual number of teeth if teeth are missing.
- **PerChSpdNom**
This parameter is used to define by how many percentage points the required speed may deviate maximally from the nominal speed in the *BIN* and *ANA* control modes. In this way, you can expand the scope in which the speeds can be requested.

You can find more information on the ECON-₄ and the identically designed SC100 in the ECON-₄ Global Guide from ComAp.

8 SETTINGS VIA GENCONFIG

8.19 Setpoints – ECON4-EngStart

The *ECON4-EngStart* group is available if you include the ECON-4 module in the module configuration when an AFR archive is selected. You also use the ECON-4 module for the MOTORTECH SC100 electronic speed controller. In this group, you can set the following parameters of the ECON-4 or SC100 speed controller:

- **InitStart dose**
Start position of the actuator at the time of engine start
- **MaxStart dose**
Maximum permissible position of the actuator at the time of engine start
- **Fuel ramp time**
Time span which the actuator requires to change from the start position at the time of engine start (*InitStart dose*) to the maximum permissible position at the time of engine start (*MaxStart dose*).
- **RPM StartRamp**
This parameter is used to define the time span which the speed controller requires to change from start speed (*Starting RPM*) to idle speed (*ECON4-EngRPM: Idle RPM*).
- **Starting RPM**
As soon as the speed threshold for the time of engine start set here is exceeded, the speed controller ends the start process and switches to normal speed control. Make sure that you have set *Starting RPM* to be lower than *ECON4-EngRPM: Idle RPM*.

You can find more information on the ECON-4 and the identically designed SC100 in the ECON-4 Global Guide from ComAp.

8.20 Setpoints – ECON4-MainPID

The *ECON4-MainPID* group is available if you include the ECON-4 module in the module configuration when an AFR archive is selected. You also use the ECON-4 module for the MOTORTECH SC100 electronic speed controller. In this group, you can set the following parameters of the ECON-4 or SC100 speed controller:

- **Speed gain**
Reinforcement of the control loop when running without load
- **Speed int**
Integration factor of the control loop when running without load
- **Speed der**
Derivation factor of the control loop when running without load
- **Load gain**
Reinforcement of the control loop when running with load
- **Load int**
Integration factor of the control loop when running with load
- **Load der**
Derivation factor of the control loop when running with load

- **Droop**
Linear reduction of the reference speed depending on the position of the actuator. The linear reduction begins with the *Idle fuel* actuator position and reaches the set maximum at the *Max Fuel* actuator position.
- **Load anticip**
This parameter is used to set the input sensitivity for the active power reported back via the *ACTIVE POWER* input. Correctly setting the parameter ensures that the speed remains stable even if the load changes quickly.
- **Max fuel**
Maximum actuator position which simultaneously limits the volume of the air/fuel mixture which can be drawn into the engine.
- **Idle fuel**
Actuator position in idle state. Set this parameter for nominal speed without load.
- **Actuator type**
Set the appropriate actuator type out of the four types preset in the speed controller.
- **Econ4 mode**
The speed controller can be operated in the *AUTO* and *MANUAL* control modes.
 - **AUTO:** Set the speed controller to this control mode for normal automatic operation.
 - **MANUAL:** In this control mode, the speed controller sets the position of the actuator via the *Act position* parameter. You can use this mode to test the function or connection of the actuator during installation, for example. You can only change to the *MANUAL* control mode when the speed controller does not register a speed.
- **Act position**
Position of the actuator in the *MANUAL* control mode
- **PWM rate**
Frequency of the pulse width modulation at the *ACT+* and *ACT-* outputs of the speed controller

You can find more information on the *ECON-4* and the identically designed *SC100* in the *ECON-4 Global Guide* from ComAp.

8.21 Setpoints – DetConzo

The *DetConzo* group is available if you include the *DetConzo* module in the module configuration when an *AFR* archive is selected. You can set the following parameters of the *DetConzo* detonation controller in this group:

- **IgnRedLimit**
Enter the limit beyond which the engine is considered to be knocking. If the value is exceeded, the *Engine Knocking* binary output is activated on the *DetConzo* and the values assigned to the analog outputs for ignition timing adjustment are altered.

8 SETTINGS VIA GENCONFIG

- **ImmStopLimit**
Enter the limit beyond which the *Trip* binary output on the DetConzo is activated. This causes the engine to switch off if properly wired.
- **DecreaseRamp**
This value is used to define with which speed the signal for the ignition timing adjustment is disabled at the respective DetConzo analog outputs as soon as the knocking falls back below *IgnRedLimit*.
- **TimingRedGain**
This value is used to influence with which speed the signal for the ignition timing adjustment increases at the respective analog outputs of the DetConzo when knocking is detected. This rate equals the mathematical product of the set value and the knocking intensity.
- **DelayLoadRed**
Enter the delay with which the ignition timing adjustment signal is to be reduced when the knocking value again falls below *IgnRedLimit* due to a load reduction.

You can get more information on the DetConzo in the DetCon Operating Manual from MOTORTECH.

8.22 Values – Statistics

The following additional statistical values are available when an AFR archive is selected in the *Statistics* value group:

- **Day kWhours**
Previously produced energy of the gen-set for the current day. The counter is set to 0 daily at 12:00 am.

For a description of all other statistical values, read the section *Values group – Statistics* in the IGS-NT-3.0 Reference Guide from ComAp for your selected archive. The ALL-IN-ONE.NT generator & CHP control system corresponds to the generator & CHP control system IS-NT-BB.

8.23 Values – AFR Control

The *AFR control* value group is available when the configuration of the connected ALL-IN-ONE.NT is based on an AFR archive. This group includes the following values:

- **MixerPosition1**
Outputs the mixer position as an analog value which the first air/gas mixer is to approach.
- **MixerPosition2**
Outputs the mixer position as an analog value which the second air/gas mixer is to approach.
- **MixerFeedback1**
Outputs the mixer position of the first air/gas mixer which the *Mixer fdb* logical analog input reports back.

- **MixerFeedback2**
Outputs the mixer position of the second air/gas mixer which the *Mixer fdbz* logical analog input reports back.
- **MAP required**
Outputs the current calculated manifold pressure target value.
- **MAP actual1**
Outputs the current manifold pressure of the first air/gas mixer which is measured via the *MAP* logical analog input.
- **MAP actual2**
Outputs the current manifold pressure of the second air/gas mixer which is measured via the *MAP2* logical analog input.
- **MAT actual**
Outputs the current manifold air temperature which is measured via the *MAT* logical analog input.
- **O₂ actual**
This value does not have a function.

8.24 Values – I-Step

The *I-Step* value group is available if the configuration of the connected ALL-IN-ONE.NT is based on an AFR archive and the I-Step module is configured. This group includes the following values:

- **Cx ActualPos**
Displays the current position of the stepper motor (*C1*=channel 1, *C2*=channel 2).
- **ChannelCmd**
Displays the command bits of the I-Step.
- **Cx Status**
Displays the status bits of the I-Step (*C1*=channel 1, *C2*=channel 2).
- **NumSteps x**
Displays the steps for the respective channel which have been counted by the I-Step during calibration.

You can find more information on the I-Step in the I-Step Reference Guide from ComAp.

8 SETTINGS VIA GENCONFIG

8.25 Values – ECON4

The *ECON4* value group is available if the configuration of the connected ALL-IN-ONE.NT is based on an AFR archive and the ECON-4 module is configured. You also use the ECON-4 module for the MOTORTECH SC100 electronic speed controller. This group includes the following values:

- **Gas dose**
Currently requested actuator position
- **Engine RPM**
Current engine speed measured by the speed controller
- **Act1 fdbck**
Current position feedback of the actuator
- **Misf Amplitude**
This value does not have a function.
- **Misf Angle**
This value does not have a function.
- **Command**
Displays the command bits of the speed controller.
- **ECON4 Status**
Displays the status bits of the speed controller.

You can find more information on the ECON-4 and the identically designed SC100 in the ECON-4 Global Guide from ComAp.

8.26 Values – DetConzo

The *DetConzo* value group is available if the configuration of the connected ALL-IN-ONE.NT is based on an AFR archive and the DetConzo module is configured. This group includes the following values:

- **AnalogOutput**
- **KnockIntensx**
Current knocking intensity of the respective cylinder
- **BO/Status**
Displays the status bits of the binary outputs and the device status of the detonation controller.
- **SensFlsx**
Displays via status bits which knock sensors have failed.

You can get more information on the DetConzo in the DetCon Operating Manual from MOTORTECH.

9 MONITORING / CONTROLLING

The IntelliMonitor SCADA software is available for monitoring and controlling the ALL-IN-ONE generator & CHP control systems using a computer.

ALL-IN-ONE generator & CHP control systems can also be controlled and monitored with special displays suitable for operation in systems. You can use the following displays with the ALL-IN-ONE.NT:

- ALL-IN-ONE.NT Display (see *ALL-IN-ONE.NT Display* on page 83)
- ALL-IN-ONE.Vision 5 (see *ALL-IN-ONE.Vision 5* on page 92)
- ALL-IN-ONE.Vision 8 (see *ALL-IN-ONE.Vision 8* on page 98)

You can connect up to three displays to the ALL-IN-ONE.NT. The user interface of the ALL-IN-ONE.Vision 5 and ALL-IN-ONE.Vision 8 displays can be individually adapted to the system and specific requirements via the GenConfig configuration software.

You can also use the ALL-IN-ONE.Vision 17 display, which is a panel PC with a Windows® operating system, with the ALL-IN-ONE.NT. In that case, install the IntelliMonitor SCADA software on the display.

For more information, read the following sections.

9.1 IntelliMonitor

You need IntelliMonitor for the following tasks:

- Monitoring single or multiple gen-set system
- Fullscreen SCADA visualization
- Display of measured and computed values
- Displaying history of connected generator & CHP control system
- Adjusting setpoints
- Receiving active calls

9 MONITORING / CONTROLLING

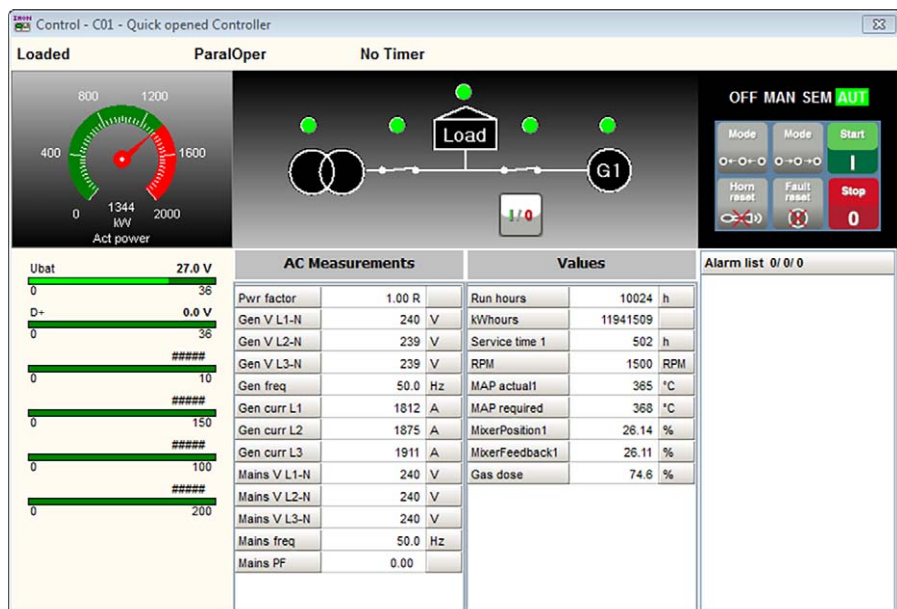

You can install IntelliMonitor via the ComAp PC Suite (see *ComAp PC Suite* on page 52). Further information on working with IntelliMonitor can be found in the IntelliMonitor 3.0 Reference Guide from ComAp.

9.2 ALL-IN-ONE.NT Display

9.2.1 Certifications

The ALL-IN-ONE.NT display is certified in compliance with the following directives:

CE

- Low Voltage Directive 2014/35/EU
- EMC Directive 2014/30/EU

The ALL-IN-ONE.NT display has been tested as per the following standards:

- Immunity for residential, commercial and light-industrial environments as per EN 61000-6-1:2007 and EN 61000-6-3:2007/A1:2011/AC:2012
- Immunity standard for industrial environments as per EN 61000-6-2:2005/AC:2005 and EN 61000-6-4:2007/A1:2011
- Shock as per EN 60068-2-27:2009
- Immunity against voltage dips, short interruptions and voltage variations on d.c. input power port as per EN 61000-4-29:2000
- Cold as per EN 60068-2-1:2007
- Dry heat as per EN 60068-2-2:2007
- Damp heat, cyclical (12 + 12 hours) as per EN 60068-2-30:2005
- Vibration (sinusoidal) as per EN 60068-2-6:2008
- Conducted disturbance measurements as per EN 55016-2-1:2014
- Immunity to conducted, common mode disturbances in the frequency range 0 Hz to 150 kHz as per EN 61000-4-16:1998/A1:2004/A2:2011
- Radiated disturbance measurements as per 55016-2-3:2010/A1:2010/AC:2013/A2:2014

EU DECLARATION OF CONFORMITY

The company: **MOTORTECH GmbH**
Hogrevestr. 21-23
29223 Celle
Germany

declares in sole responsibility that the product: **ALL-IN-ONE.NT Display**

intended purpose: **Display unit for gen-set controllers**
ALL-IN-ONE.NT/.NTC

complies with the provisions of the following EU Directives: **Low Voltage Directive 2014/35/EU**
EMC Directive 2014/30/EU

under consideration of the following standards: **EN 61000-6-1:2007**
EN 61000-6-2:2005/AC:2005
EN 61000-6-3:2007/A1:2011/AC:2012
EN 61000-6-4:2007/A1:2011
EN 60068-2-27:2009, EN 61000-4-29:2000
EN 60068-2-1:2007, EN 60068-2-2:2007
EN 60068-2-30:2005, EN 60068-2-6:2008
EN 55016-2-1:2014
EN 61000-4-16:1998/A1:2004/A2:2011
EN 55016-2-3:2010/A1:2010/AC:2013/A2:2014

The marking of the product is: **P/N 63.50.103**

This declaration is submitted by: Name: Florian Virchow
Position in company: Managing Director

Celle, 2016-08-11
Place, date 

Legally binding signature

9.2.2 Mechanical Data

The ALL-IN-ONE.NT display has the following mechanical properties:

Feature	Value
Dimensions	Device: 290 mm x 184 mm x 30 mm (11.42" x 7.25" x 1.19") (length x width x height)
Weight	1.3 kg (2.9 lbs)
Mounting	On basebox, as remote display
Mechanical environmental conditions	Protection class of front panel: IP65
Climatic environmental conditions	Operation: -20 °C to +70 °C (-4 °F to +158 °F) Storage: -30 °C to +80 °C (-22 °F to +176 °F) Max. 95 % humidity without condensation

9.2.3 Warning Notices on the Device

Device Rear Side Warning Information

Max. ambient temperature 70 °C

9.2.4 Product Identification – Labeling on the Device

The numbers required for unique product identification are on the device:

- P/N: product number of the display
- HW version: hardware version and production code of the display
- Barcode and number: serial number of the display



9 MONITORING / CONTROLLING

9.2.5 Electrical Data

The ALL-IN-ONE.NT display has the following electrical properties:

Feature	Value
Power supply	8 V DC to 36 V DC
Required current	0.3 A at 8 V DC 0.1 A at 24 V DC 0.09 A at 30 V DC

9.2.6 Display

The ALL-IN-ONE.NT display has the following properties:

Feature	Value
Display dimensions	115.2 mm x 86.4 mm (4.54" x 3.4") (width x height)
Screen diagonal	145 mm (5.7")
Type	FSTN, monochrome
Resolution	320 x 240 pixels
Pixel size	0.33 mm x 0.36 mm

9.2.7 Interfaces

RS485

- Maximum length: 1 km (3,280')

9.2.8 Buttons and LEDs on the Device





You can operate the ALL-IN-ONE.NT generator & CHP control system using the keys on the front panel of the ALL-IN-ONE.NT Display. The following tables give an overview of the keys and their functions.





Numerical Keypad 1

Key	Function
	<p>Sign Key Depending on the context, the key has the following function:</p> <ul style="list-style-type: none"> – When entering parameters, the preceding sign is changed if the respective parameter allows positive and negative values. – Displays the symbol in the <i>History</i> view. When the symbol is displayed, you can leaf through the pages of the recording with the \uparrow and \downarrow arrow buttons of the navigation key block (see below).
	<p>Separator Key Key for entering numbers with decimal places or for separating the numbers of an IP address.</p>



9 MONITORING / CONTROLLING

Key	Function
	Number Keys Keys for entering numbers
	Clear Depending on the context, the key has the following function: <ul style="list-style-type: none">– Deletes the character left of the cursor.– <i>History view</i>: Calls up the first column of the first history page.
	Enter Depending on the context, the key has one of the following functions: <ul style="list-style-type: none">– Adopts entry or selection– All <i>Metering</i> views: For quick editing of the <i>ProcessControl: Base load</i> parameter, press the <i>Enter</i> key for 4 seconds.– All <i>Setpoints</i> views: opens selected parameter for editing– <i>Language view</i>: saves selection and exits the language window

Control Keys 2







Key	Function
	<p>Operation Mode Changes between the operation modes of the ALL-IN-ONE.NT in the desired direction.</p>
	<p>Alarm Tone Reset This key is used to deactivate the alarm tone without confirming alarms.</p>
	<p>Alarm Confirmation You confirm active alarms and deactivate the alarm tone with this key.</p>
	<p>Start This key is used to initiate the start sequence of the gen-set in the <i>MAN</i> and <i>SEM</i> operation modes.</p>
	<p>Stop This key is used to initiate the stop sequence of the gen-set in the <i>MAN</i> and <i>SEM</i> operation modes. By pressing the key twice or holding it down for more than 2 seconds, the stop sequence is interrupted at the respective point (for example, generator unloading or aftercooling), the generator circuit breaker is opened and the gen-set is immediately stopped.</p>

Shortcut Keys 3

Key	Function
	<p>Alarm List Calls up the <i>AlarmList</i> view.</p>
	<p>History Calls up the <i>History</i> view.</p>

9 MONITORING / CONTROLLING

Navigation Keys 4

Key	Function
 	<p>Depending on the context, the keys have the following function:</p> <ul style="list-style-type: none">– Navigate in a selection list– All <i>Metering</i> views: navigate between the <i>Metering</i> views– Increase or decrease parameter values– <i>History</i> view: leaf between the pages of the recording when the  symbol is displayed
 	<p>Depending on the context, the keys have the following function:</p> <ul style="list-style-type: none">– All <i>Setpoints</i> views: jump to the beginning or the end of the list on the current or the next page– <i>AlarmList</i> view: leaf through pages, upwards or downwards– <i>History</i> view: move displayed column to the left or right
	<p>Escape</p> <p>Depending on the context, the key has one of the following functions:</p> <ul style="list-style-type: none">– Leaves current view without changes– Cancels editing of a parameter without changes– Leaves the <i>Language</i> view without changes– In the character table: toggle between the character table, the menu bar and the text line
	<p>Enter</p> <p>Corresponds to the <i>Enter</i> key of the numerical keypad of the ALL-IN-ONE.NT Display. For further information, see the <i>Numerical Keypad</i> table above.</p>

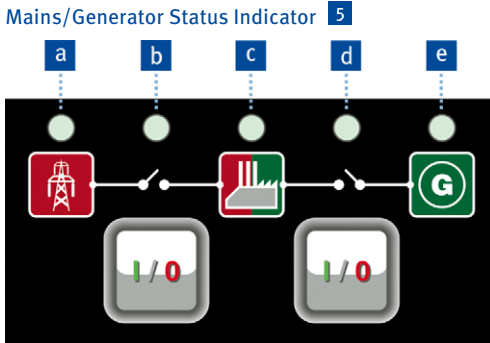

The I/O keys open or close the respective circuit breaker.

The LEDs in this area show the following statuses:

Pos.	Status indicator
a	Mains
b	Mains circuit breaker position Using the I/O keys, you can open and close the mains circuit breaker in the <i>MAN</i> operation mode.
c	Load
d	Generator circuit breaker position Using the I/O keys, you can open and close the generator circuit breaker in the <i>MAN</i> operation mode.
e	Generator

You can find more information on operating the ALL-IN-ONE.NT Display in the IGS-NT-3.0 Operator Guide from ComAp in the following sections:

- *InteliSysNT Basebox pushbuttons and LEDs*
- *Description of InteliSysNT MEASUREMENT screens*

The ALL-IN-ONE.NT Display corresponds to the IS Display.

9 MONITORING / CONTROLLING

9.3 ALL-IN-ONE.Vision 5

9.3.1 Certifications

The ALL-IN-ONE.Vision 5 is certified in compliance with the following directives:

CE

- Low Voltage Directive 2014/35/EU
- EMC Directive 2014/30/EU
 - Immunity for residential, commercial and light-industrial environments as per EN 61000-6-1:2007 and EN 61000-6-3:2007/A1:2011/AC:2012
 - Immunity standard for industrial environments as per EN 61000-6-2:2005/AC:2005 and EN 61000-6-4:2007/A1:2011

EU DECLARATION OF CONFORMITY

The company:

**MOTORTECH GmbH
Hogrevestr. 21-23
29223 Celle
Germany**

declares in sole responsibility that the product:

ALL-IN-ONE.Vision 5 – TFT Color Display

intended purpose:

**Display unit for gen-set controllers
ALL-IN-ONE.NT/.NTC**

complies with the provisions of the following EU Directives:

**Low Voltage Directive 2014/35/EU
EMC Directive 2014/30/EU**

under consideration of the following standards:

**EN 61000-6-1:2007
EN 61000-6-2:2005/AC:2005
EN 61000-6-3:2007/A1:2011/AC:2012
EN 61000-6-4:2007/A1:2011**

The marking of the product is:

P/N 63.50.105

This declaration is submitted by:

Name: Florian Virchow

Position in company: Managing Director

Celle, 2016-08-11

Place, date



Legally binding signature

9 MONITORING / CONTROLLING

9.3.2 Mechanical Data

The ALL-IN-ONE.Vision 5 has the following mechanical properties:

Feature	Value
Dimensions	245 mm x 164 mm x 61 mm (9.65" x 6.45" x 2.4") (length x width x height)
Weight	855 g (1.89 lbs)
Mounting	Engine room, engine
Mechanical environmental conditions	Protection class of front panel: IP65
Climatic environmental conditions	Operation: -40 °C to +70 °C (-40 °F to +158 °F) Storage: -30 °C to +80 °C (-22 °F to +176 °F) Max. 85 % humidity without condensation

9.3.3 Warning Notices on the Device

For use on a flat surface of a type 1 enclosure

User copper conductors only

Max. ambient temperature 70 °C

Refer to installation instructions for torque values

9.3.4 Product Identification – Labeling on the Device

The numbers required for unique product identification are on the device.

Lower Device Side

- P/N: product number of the display

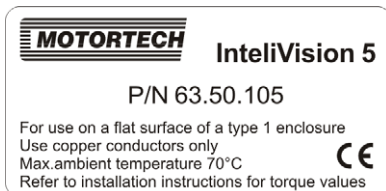

For an overview of the warning information on the device plate, see also section *Warning Notices on the Device* on page 94.

Upper Device Side

- HW version: hardware version and production code of the display
- Barcode and number: serial number of the display



9.3.5 Electrical Data

The ALL-IN-ONE.Vision 5 has the following electrical properties:

Feature	Value
Power supply	8 V DC to 36 V DC
Required current	0.7 A at 8 V DC 0.55 A at 24 V DC 0.45 A at 36 V DC

9.3.6 Display

The display of the ALL-IN-ONE.Vision 5 has the following properties:

Feature	Value
Display dimensions	115.2 mm x 86.4 mm (4.54" x 3.4") (width x height)
Screen diagonal	145 mm (5.7")
Type	TFT, color
Resolution	320 x 240 pixels
Pixel size	0.12 mm x 0.36 mm

9.3.7 Interfaces

RS485

- Speed: up to 57.6 kBd
- Maximum length: 2 m (6.56')

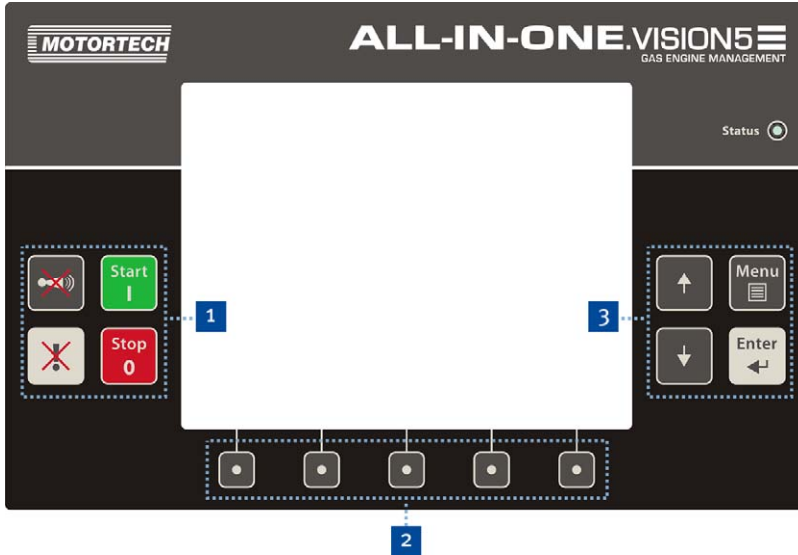

9 MONITORING / CONTROLLING

9.3.8 Buttons and LEDs on the Device



You can operate the ALL-IN-ONE.NT generator & CHP control system using the keys of the front panel of the ALL-IN-ONE.Vision 5. The LED *Status* shows that ALL-IN-ONE.Vision 5 is in operation. The following tables give an overview of the keys and their functions.

Control Keys 1

Key	Function
	Alarm Confirmation You confirm active alarms and deactivate the alarm tone with this key.
	Alarm Tone Reset This key is used to deactivate the alarm tone without confirming alarms.
	Start This key is used to initiate the start sequence of the gen-set in the <i>MAN</i> and <i>SEM</i> operation modes.

Key	Function
	<p><i>Stop</i></p> <p>This key is used to initiate the stop sequence of the gen-set in the <i>MAN</i> and <i>SEM</i> operation modes. By pressing the key twice or holding it down for more than 2 seconds, the stop sequence is interrupted at the respective point (for example, generator unloading or aftercooling), the generator circuit breaker is opened and the gen-set is immediately stopped.</p>





Context Keys 2

The context keys can be modified via the *Screen Editor* of the GenConfig configuration software (see section *InteliVision Screen Editor* in the GenConfig 3.0 Reference Guide from ComAp). In addition, their assignment changes in certain views. They are pre-assigned as follows in the main views:

Key	Function
Open/Close MCB	<p><i>Mains Circuit Breaker Control</i></p> <p>Opens or closes the mains circuit breaker in the <i>MAN</i> operation mode (available with certain archives).</p>
Open/Close GCB	<p><i>Generator Circuit Breaker Control</i></p> <p>Closes or opens the generator circuit breaker in <i>MAN</i> operation mode.</p>
AlarmList	<p><i>Alarm List</i></p> <p>Calls up the <i>AlarmList</i> view.</p>
History	<p><i>History</i></p> <p>Calls up the <i>History</i> view.</p>
Mode	<p><i>Operation Mode</i></p> <p>Calls up the dialog window for selection of the operation mode.</p>

9 MONITORING / CONTROLLING

Navigation Keys 3

Key	Function
 	Keys for navigation
	Menu Depending on the context, the key has the following function: <ul style="list-style-type: none">– Calls up or exits the navigation menu– Exits parameter editing without changes
	Enter This key is used to select entries from menus or lists, open parameters for editing and confirm entered parameter values.

You can find more information on operating the ALL-IN-ONE.Vision 5 in the following publications:

- *InteliVision 5 Reference Guide* from ComAp
- Section *InteliVision 5* in the *IGS-NT-3.0 Operator Guide* from ComAp

The ALL-IN-ONE.Vision 5 corresponds to *InteliVision 5*.

The user interface of the ALL-IN-ONE.Vision 5 can be individually adapted in the *Screen Editor* of the GenConfig configuration software. For more information, read the section *InteliVision Screen Editor* in the *GenConfig 3.0 Reference Guide* from ComAp.

9.4 ALL-IN-ONE.Vision 8

9.4.1 Certifications

The ALL-IN-ONE.Vision 8 is certified in compliance with the following directives:

CE

- Low Voltage Directive 2014/35/EU
- EMC Directive 2014/30/EU
 - Immunity for residential, commercial and light-industrial environments as per EN 61000-6-1:2007 and EN 61000-6-3:2007/A1:2011/AC:2012
 - Immunity standard for industrial environments as per EN 61000-6-2:2005/AC:2005 and EN 61000-6-4:2007/A1:2011

EU DECLARATION OF CONFORMITY

The company: **MOTORTECH GmbH**
Hogrevestr. 21-23
29223 Celle
Germany

declares in sole responsibility that the product: **ALL-IN-ONE.Vision 8 – TFT Color Display**

intended purpose: **Display unit for gen-set controllers**
ALL-IN-ONE.NT/.NTC

complies with the provisions of the following EU Directives: **Low Voltage Directive 2014/35/EU**
EMC Directive 2014/30/EU

under consideration of the following standards: **EN 61000-6-1:2007**
EN 61000-6-2:2005/AC:2005
EN 61000-6-3:2007/A1:2011/AC:2012
EN 61000-6-4:2007/A1:2011

The marking of the product is: **P/N 63.50.101**

This declaration is submitted by:
Name: Florian Virchow Position in company: Managing Director

Celle, 2016-08-11
Place, date

Legally binding signature

9.4.2 Mechanical Data

The ALL-IN-ONE.Vision 8 has the following mechanical properties:

Feature	Value
Dimensions	289,5 mm x 186 mm x 33,6 mm (11.4" x 7.33" x 1.33") (length x width x height)
Weight	1.6 kg (3.6 lbs)
Mounting	Engine room, engine
Mechanical environmental conditions	Protection class of front panel: IP65
Climatic environmental conditions	Operation: -20 °C to +70 °C (-4 °F to +158 °F) Storage: -30 °C to +80 °C (-22 °F to +176 °F) Max. 95 % humidity without condensation

9.4.3 Warning Notices on the Device

For use on a flat surface of a type 1 enclosure

Max. ambient temperature 70 °C

User copper conductors only

Refer to installation instructions for torque values

9.4.4 Product Identification – Labeling on the Device

The numbers required for unique product identification are on the device:

- P/N: product number of the display
- HW version: hardware version of the display
- Barcode and number: serial number of the display



9 MONITORING / CONTROLLING

9.4.5 Electrical Data

The ALL-IN-ONE.Vision 8 has the following electrical properties:

Feature	Value
Power supply	8 V DC to 36 V DC
Required current	1 A at 8 V DC 0.35 A at 24 V DC 0.25 A at 36 V DC

9.4.6 Display

The display of the ALL-IN-ONE.Vision 8 has the following properties:

Feature	Value
Display dimensions	162 mm x 121.5 mm (6.38" x 4.79") (width x height)
Screen diagonal	204 mm (8")
Type	TFT, color
Resolution	800 x 600 pixels
Pixel size	0.2025 mm x 0.2025 mm
Viewing angle	From left, below and right: – At least 60°, optimally from 70° From above: – At least 40°, optimally from 50°
Contrast ratio	At least 400:1, in optimal range 500:1
Brightness	Display center: at least 300 cd/m ² , in optimal range 350 cd/m ²
Display lifetime	At least 20,000 operating hours

9.4.7 Interfaces

RS232

- Speed: up to 57.6 kBd
- Maximum length: 10 m (32')

RS485

- Galvanically isolated
- Speed: up to 57.6 kBd
- Maximum length: 1,000 m (3,280')

CAN

- Galvanically isolated
- Maximum CAN bus length: 200 m (656') at 250 kBd
- Nominal impedance: 120 Ω
- Cable type: STP

9 MONITORING / CONTROLLING

9.4.8 Buttons and LEDs on the Device

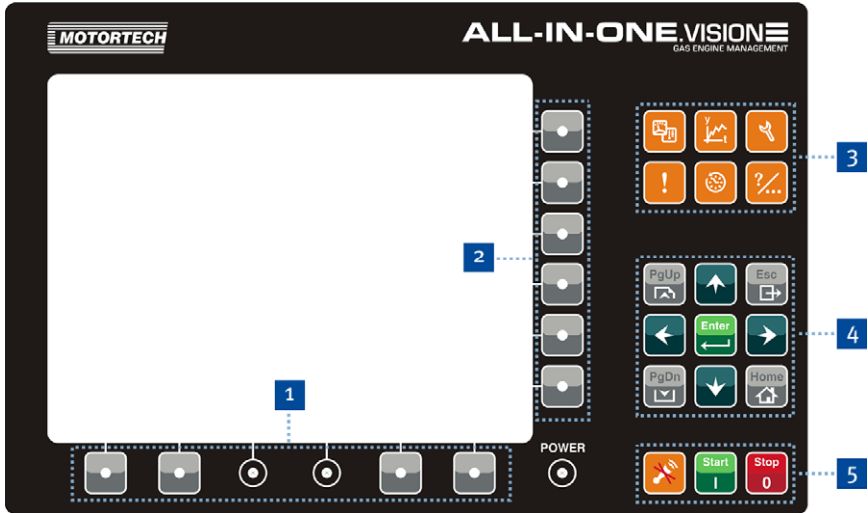

You can operate the ALL-IN-ONE.NT generator & CHP control system using the keys of the front panel of the ALL-IN-ONE.Vision 8. The *Power* LED shows that the ALL-IN-ONE.Vision 8 is in operation.

The following tables give an overview of the keys and their functions.

Lower Context Key Group ¹







The context keys of this group can be modified via the *Screen Editor* of the GenConfig configuration software (see section *InteliVision Screen Editor* in the GenConfig 3.0 Reference Guide from ComAp). They are pre-assigned as follows:

Key	Function
Open/Close MCB	Mains Circuit Breaker Control Opens or closes the mains circuit breaker in the <i>MAN</i> operation mode (available with certain archives).
Open/Close GCB	Generator Circuit Breaker Control Closes or opens the generator circuit breaker in <i>MAN</i> operation mode.
Fault reset	Alarm Confirmation You confirm active alarms and deactivate the alarm tone with this key.
Controller mode	Operation Mode Opens a context menu which you can use to set the desired operation mode of the ALL-IN-ONE.NT.

Side Context Key Group ²









You can use the context keys of this group to select sub-menu items in certain views and for certain functions. If more than six sub-menu items are available, you can call up more sub-menu items using the *PgUp* and *PgDn* keys.

Shortcut Keys ³



Key	Function
	<p><i>Measurement Results</i> Opens a context menu with which you can select the desired <i>Metering</i> view.</p>
	<p><i>Runtime Data</i> Calls up the <i>Trends</i> view.</p>
	<p><i>Setpoints</i> Opens a context menu which you can use to call up the desired group to check or change the setting of parameters (<i>setpoints</i>).</p>
	<p><i>Alarm List</i> Calls up the <i>AlarmList</i> view.</p>
	<p><i>History</i> Calls up the <i>History</i> view.</p>
	<p><i>Help/Other</i> Calls up the <i>Help/Other</i> context menu which you can use to make other settings (language selection, communication settings, etc.).</p>

9 MONITORING / CONTROLLING

Navigation Keys 4

Key	Function
 	Keys for navigation
 	
 	<i>Page Up, Page Down</i> Depending on the context, the keys have one of the following functions: <ul style="list-style-type: none">– Leaf through context menu– In certain views: move up or down within the page when context menu is inactive
	<i>Escape</i> Leaves the current dialog window or menu or interrupts an action.
	<i>Enter</i> Confirms a value or opens a setting parameter for changes.
	<i>Home Key</i> Calls up the start view of the <i>Metering</i> views.

Control Keys 5

Key	Function
	<p>Alarm Tone Reset</p> <p>This key is used to deactivate the alarm tone without confirming alarms.</p>
	<p>Start</p> <p>This key is used to initiate the start sequence of the gen-set in the <i>MAN</i> and <i>SEM</i> operation modes.</p>
	<p>Stop</p> <p>This key is used to initiate the stop sequence of the gen-set in the <i>MAN</i> and <i>SEM</i> operation modes. By pressing the key twice or holding it down for more than 2 seconds, the stop sequence is interrupted at the respective point (for example, generator unloading or aftercooling), the generator circuit breaker is opened and the gen-set is immediately stopped.</p>

You can find more information on operating the ALL-IN-ONE.Vision 8 in the following publications:

- IntelliVision 8 Reference Guide from ComAp
- Section *IntelliVision 8* in the IGS-NT-3.0 Operator Guide from ComAp

The ALL-IN-ONE.Vision 8 corresponds to IntelliVision 8.

The user interface of the ALL-IN-ONE.Vision 8 can be individually adapted in the *Screen Editor* of the GenConfig configuration software. For more information, read the section *IntelliVision Screen Editor* in the GenConfig 3.0 Reference Guide from ComAp.

9.5 Modbus

Note that the history of the ALL-IN-ONE.NT cannot be read out via the RTU protocol when using the Modbus communication protocol.

You can find more information on using the Modbus communication protocol in the section *Monitoring local on site - MODBUS* in the IGS-NT-3.0 Communication Guide from ComAp. The ALL-IN-ONE.NT generator & CHP control system corresponds to the generator & CHP control system IS-NT-BB.

10 RUNTIME DATA VIA WINSCOPE

For the following tasks, you need WinScope in connection with the ALL-IN-ONE.NT generator & CHP control system:

- Displaying runtime data
- Recording runtime data
- Saving a runtime data recording
- Displaying a runtime data recording

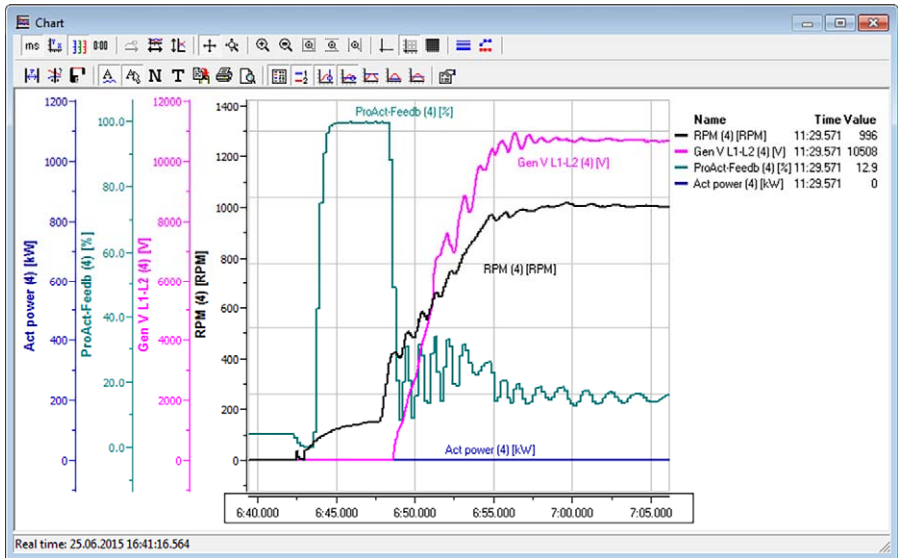

You can install WinScope via the ComAp PC Suite (see *ComAp PC Suite* on page 52). Further information on working with WinScope can be found in the WinScope 2.0 Reference Guide from ComAp.

11 OPERATION

11.1 Start-up

Information on start-up of the ALL-IN-ONE.NT generator & CHP control system can be found in the IGS-NT-3.0 Installation Guide from ComAp. The ALL-IN-ONE.NT generator & CHP control system corresponds to the generator & CHP control system IS-NT-BB.

11.2 Firmware Update



Operational safety!

Before a firmware update, remove all binary outputs including the control connectors of the generator circuit breaker to prevent damage to the system. Also observe the information you receive in the firmware documentation.

After a firmware update, the ALL-IN-ONE.NT is in an undefined state. Restart the generator & CHP control system and check its configuration carefully. Only after having successfully checked the configuration, reconnect the wiring in order to restart the system.

The GenConfig configuration software is used to perform firmware updates for the ALL-IN-ONE.NT generator & CHP control system. Note that GenConfig is downward compatible for firmware updates, but not upward compatible. You should therefore install the newest version of GenConfig via the current ComAp PC Suite before every firmware update. Also observe the information you receive in the firmware documentation.

You can find more information about running firmware updates in the GenConfig 3.0 Reference Guide from ComAp in the section *Controller firmware upgrade*.

Contact your MOTORTECH contact person if you have any questions on the firmware update.

12 ERRORS

12.1 Possible Faults

You can find information on troubleshooting for the ALL-IN-ONE.NT generator & CHP control system in the IGS-NT-3.0 Troubleshooting Guide from ComAp. The ALL-IN-ONE.NT generator & CHP control system corresponds to the generator & CHP control system IS-NT-BB.

12.2 Customer Service Information

You can reach our customer service during business hours at the following phone and fax number, or by email:

Phone: +49 5141 93 99 0

Fax: +49 5141 93 99 99

Email: service@motortech.de

12.3 Returning Equipment for Repair / Inspection

To return the device for repair and inspection, obtain a return form and return number from MOTORTECH.

Fill out the return form completely. The completely filled out return form guarantees fast, uncomplicated processing of your repair order.

Send the device and the return form to one of the two addresses below or to the nearest MOTORTECH representative:

MOTORTECH GmbH

Hogrevestr. 21-23
29223 Celle

Germany

Phone: +49 5141 93 99 0

Fax: +49 5141 93 99 98

www.motortech.de

motortech@motortech.de

MOTORTECH Americas, LLC

1400 Dealers Avenue, Suite A
New Orleans, LA 70123

USA

Phone: +1 504 355 4212

Fax: +1 504 355 4217

www.motortechamericas.com

info@motortechamericas.com

12.4 Instructions for Packaging the Equipment

For return shipment, equipment should be packaged as follows:

- Use packaging material that does not damage the equipment surfaces.
- Wrap the equipment with sturdy materials and stabilize it inside the packaging.
- Use sturdy adhesive film to seal the packaging.

13 MAINTENANCE

13.1 Maintenance Instructions

When performing more extensive maintenance work, regularly check that the emission values are being adhered to via the manifold pressure characteristic configured in the ALL-IN-ONE.NT.

Observe the following information when doing maintenance work on the system:



Risk of injury or death!

The generator & CHP control system can be controlled remotely. During maintenance work on the gen-set, make absolutely sure that the engine cannot be started.

Disconnect the following connections:

- Remote control via RS232 or another communication connection
 - *Rem start/stop* input
- or
- *Starter, GCB close/open, MCB close/open* outputs



Operational safety!

Note that the states of the binary outputs can change during and after the configuration of the device software. Before you put the generator & CHP control system back into operation, make absolutely sure that the configuration and parameter settings match your system.



Risk of injury or death!

Note that the mains circuit breaker can be closed and the gen-set started when you disconnect at least one of the following connections on the generator & CHP control system:

- Mains voltage measurement
- Binary outputs for the control of the mains circuit breaker
- Feedback of the mains circuit breaker

To prevent automatic gen-set start or closing of the generator circuit breaker during all work on the gen-set or the switch panel, ensure the following:

- Switch the generator & CHP control system to manual mode.
- Disconnect the *Starter* and *Fuel solenoid* binary outputs or press the emergency stop button.

13 MAINTENANCE

13.2 Spare Parts and Accessories

For spare parts and accessories, please refer to our current Product Guide, which is available for you to download on the internet at www.motortech.de.

14 INDEX

A

Abbreviations	8
Act. calls/SMS	69
Active power measured value filter	37
AFR archives	57
AFR control	
Setpoints	70
Values	78
Air/gas mixers, two	43
Alarm notifications	49
ALL-IN-ONE control system	
Application	16
Dimensions	20, 26
Disposal	15
Electrical data	21
Function	16
Mechanical data	20
Memory space	56
Mounting	31
Return	110
Start-up	109
ALL-IN-ONE.NT Display	83
ALL-IN-ONE.Vision 5	92
ALL-IN-ONE.Vision 8	99
Analog inputs	
Description	64
Electrical data	21
Analog mixer control	36
Application Guide VDE-AR-N 4105	51
Archives	57

B

Basic settings	65
BDEW Medium Voltage Guideline	51
Binary inputs	
Description	61
Electrical data	21
Binary mixer control	36
Binary outputs	
Description	62
Electrical data	21
Buttons	
ALL-IN-ONE.NT Display	87
ALL-IN-ONE.Vision 5	96
ALL-IN-ONE.Vision 8	104

C

CAN bus	
ALL-IN-ONE control system	24
ALL-IN-ONE.Vision 8	103

Certifications

ALL-IN-ONE control system	18
ALL-IN-ONE.NT Display	83
ALL-IN-ONE.Vision 5	92
ALL-IN-ONE.Vision 8	99
ComAp PC Suite	52
Comms settings	66
Conduct with off load	46
Configuration	54
Cylinder temperature, measuring inputs	34

D

Declaration of conformity	
ALL-IN-ONE control system	18
ALL-IN-ONE.NT Display	83
ALL-IN-ONE.Vision 5	92
ALL-IN-ONE.Vision 8	99
DetCon2o	
Modules	61
Setpoints	77
Values	80
Detonation controller	46
Device	
Application	16
Dimensions	20, 26
Disposal	15
Electrical data	21
Function	16
Mechanical data	20
Memory space	56
Mounting	31
Return	110
Start-up	109
Dimensions	20, 26

Display

ALL-IN-ONE.NT Display	83
ALL-IN-ONE.Vision 5	92
ALL-IN-ONE.Vision 8	99

E

ECON4	
EngRPM	75
EngStart	76
MainPID	76
Values	80
ECU list	
Description	50
Install	53
Setting	60

14 INDEX

Electrical data	
ALL-IN-ONE control system.....	21
ALL-IN-ONE.NT Display.....	86
ALL-IN-ONE.Vision 5.....	95
ALL-IN-ONE.Vision 8	102
Engine protect	66
Engine shutdown timer.....	49
EngRPM.....	75
EngStart	76
Evaluation parameters mains voltage.....	37
F	
Firmware update	109
Fixed mixer position	
Description	38
Methane content adjustment	40
Function enabling hardware dongle.....	34
G	
Gas ventilation test	35
GenConfig	
AFR archives	57
Program mode	59
H	
Hardware dongle.....	34
Hardware version	
ALL-IN-ONE control system.....	21
ALL-IN-ONE.NT Display.....	85
ALL-IN-ONE.Vision 8	101
I	
Idle time	46
IntelIMonitor.....	81
Interfaces	
ALL-IN-ONE control system.....	24
ALL-IN-ONE.NT Display.....	86
ALL-IN-ONE.Vision 5.....	95
ALL-IN-ONE.Vision 8	103
I-Step	
Setpoints.....	74
Values	79
J	
Jumpers.....	26
L	
LED	
ALL-IN-ONE.NT Display.....	87
ALL-IN-ONE.Vision 5.....	96
ALL-IN-ONE.Vision 8	104
Logical analog inputs	
Description	64
Electrical data	21
Logical binary inputs	
Description	61
Electrical data	21
Logical binary outputs	
Description	62
Electrical data	21
M	
MainPID.....	76
Mains protect.....	67
Mains protections, signaling of	49
Mains voltage evaluation parameters	37
Maintenance.....	111
Measuring inputs cylinder temperatures.....	34
Mechanical data	
ALL-IN-ONE control system.....	20
ALL-IN-ONE.NT Display	85
ALL-IN-ONE.Vision 5.....	94
ALL-IN-ONE.Vision 8.....	101
Methane content adjustment	40
Misfire protection.....	45
Mixer control.....	36
Mixture control	
Description	38
Mode	42
Power-dependent	41
Mixture control mode	42
Modbus	107
Modules	61
MOTORTECH	
Address	110
ECUs.....	50, 60
Mounting.....	31
O	
Off load, conduct with.....	46
Operation with MOTORTECH devices.....	50
Overspeed alarm reset.....	48
Overspeed protection	36
P	
Power-dependent air/fuel mixture control.....	41
Process Control.....	65
Product identification	
ALL-IN-ONE control system.....	21
ALL-IN-ONE.NT Display	85
ALL-IN-ONE.Vision 5.....	94
ALL-IN-ONE.Vision 8.....	101
Product number	
ALL-IN-ONE control system.....	21
ALL-IN-ONE.NT Display.....	85
ALL-IN-ONE.Vision 5.....	94
ALL-IN-ONE.Vision 8.....	101

Program mode.....	59	Start blocking delay.....	49
R		Start-up	109
Regulations		Statistics.....	78
ALL-IN-ONE control system	18	Sync/Load ctrl	69
ALL-IN-ONE.NT Display	83	Synchronization attempts	37
ALL-IN-ONE.Vision 5	92	T	
ALL-IN-ONE.Vision 8.....	99	Two air/gas mixers	43
Repair.....	110	U	
Required current.....	21	Update.....	109
Reset overspeed alarm.....	48	USB	24
Return shipment.....	110	V	
RS232 interface		Values	
ALL-IN-ONE control system	24	AFR control	78
ALL-IN-ONE.Vision 8	103	DetCon20	80
RS485 interface		ECON4.....	80
ALL-IN-ONE control system	24	I-Step	79
ALL-IN-ONE.NT Display	86	Statistics.....	78
ALL-IN-ONE.Vision 5	95	VDE-AR-N 4105.....	51
ALL-IN-ONE.Vision 8.....	103	W	
S		Warning notices	
Safety instructions	13, 14	ALL-IN-ONE control system	20
Scope of supply.....	31	ALL-IN-ONE.NT Display	85
Serial number		ALL-IN-ONE.Vision 5	94
ALL-IN-ONE control system	21	ALL-IN-ONE.Vision 8	101
ALL-IN-ONE.NT Display	85	WinScope.....	108
ALL-IN-ONE.Vision 8.....	101	Wiring	32
Service timer shutdown	49		
Setpoints			
Act. calls/SMS.....	69		
AFR control.....	70		
Basic settings.....	65		
Comms settings.....	66		
DetCon20.....	77		
ECON4-EngPRM	75		
ECON4-EngStart	76		
ECON4-MainPID	76		
Engine protect	66		
I-Step.....	74		
Mains protect	67		
Process Control	65		
Sync/Load ctrl.....	69		
Signaling of mains protections	49		
Software			
ComAp PC Suite.....	52		
GenConfig	54		
IntelIMonitor	81		
WinScope.....	108		

Original MOTORTECH® Accessories for Stationary Gas Engines

As a supplier, MOTORTECH develops, produces and distributes accessories as well as spare and wearing parts for nearly all kinds of stationary gas engines worldwide: Ignition control and monitoring, industrial spark plugs and spark plug leads, wiring systems and gas regulation – from detonation to speed control up to complete gas engine management. On-site support and special training courses complete our service.



MOTORTECH GmbH

Hogrevestr. 21-23
29223 Celle
Germany
Phone: +49 5141 93 99 0
Fax: +49 5141 93 99 99
www.motortech.de
motortech@motortech.de

MOTORTECH Americas, LLC

1400 Dealers Avenue, Suite A
New Orleans, LA 70123
USA
Phone: +1 504 355 4212
Fax: +1 504 355 4217
www.motortechamericas.com
info@motortechamericas.com