

# EMCON5 – EMISSION CONTROLLER

## OPERATING MANUAL

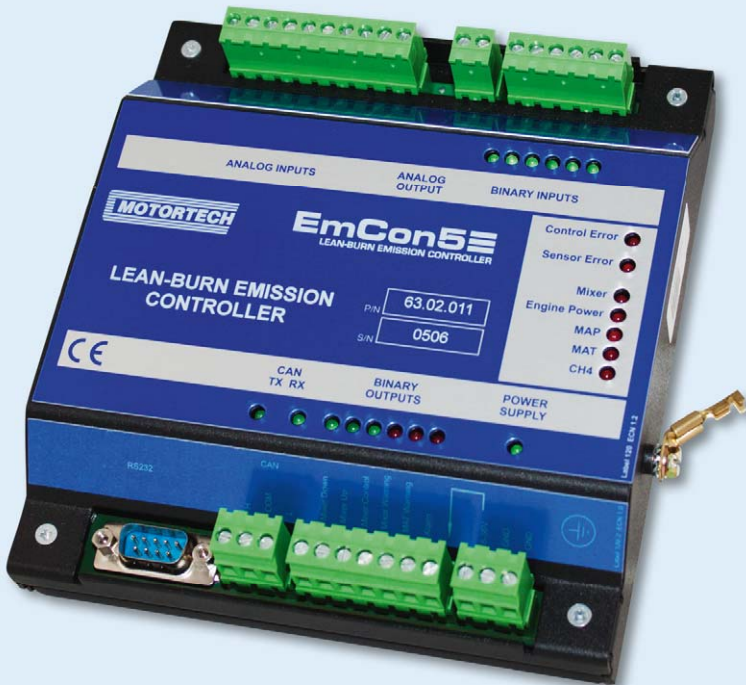

**EmCon5**  
MOTORTECH LEAN-BURN EMISSION CONTROLLER

### Copyright

© Copyright 2016 MOTORTECH GmbH. All rights reserved.

Distribution and reproduction of this publication or parts thereof, regardless of the specific purpose and form, are not permissible without express written approval by MOTORTECH. Information contained in this publication may be changed without prior notice.

### Trademarks

MOTORTECH products and the MOTORTECH logo are registered and/or common law trademarks of the MOTORTECH Holding GmbH. All other trademarks and logos displayed or used in this publication are the property of the respective entitled person.

# TABLE OF CONTENTS

<b>1 General Information .....</b>	<b>6</b>
1.1 What Is the Purpose of this Operating Manual? .....	6
1.2 Who Is this Operating Manual Targeted to? .....	6
1.3 Which Symbols Are Used in the Operating Manual? .....	6
1.4 Which Abbreviations/Acronyms Are Used in the Operating Manual? .....	7
<b>2 Safety Instructions .....</b>	<b>9</b>
2.1 General Safety Instructions .....	9
2.2 Electrostatic Discharge Hazards .....	9
2.3 Information on Electric Isolation .....	10
2.4 Special Safety Instructions for the Device .....	11
2.5 Proper Disposal.....	13
<b>3 Intended Use .....</b>	<b>14</b>
3.1 Functional Description .....	14
3.2 Applications.....	18
<b>4 Product Description .....</b>	<b>19</b>
4.1 Technical Data .....	19
4.1.1 Certifications .....	19
4.1.2 Mechanical Data .....	21
4.1.3 Electrical Data.....	21
4.1.4 Interfaces .....	22
4.1.5 Overview Drawings.....	23
<b>5 Installation Instructions.....</b>	<b>26</b>
5.1 Unpacking.....	26
5.2 Installation of the Emission Controller .....	26
5.3 Installation of Sensors .....	27
<b>6 Wiring of the Device.....</b>	<b>28</b>
6.1 Wiring – Analog Connections .....	28
6.1.1 Set Jumpers .....	29
6.2 Wiring – Binary Inputs .....	31
6.3 Wiring – CAN Bus Interface.....	32
6.4 Wiring – Binary Outputs .....	33
6.5 Wiring – Power Supply .....	34
<b>7 Functions .....</b>	<b>35</b>
7.1 Overview of Functions .....	35
7.2 Mixture Control Modes.....	37

# TABLE OF CONTENTS

7.3 Power-Dependent Air/Fuel Mixture Control.....	38
7.4 Configurable Fixed Mixer Position Sets .....	39
7.5 Configurable Sensor Inputs .....	40
7.6 Methane Content Adjustment of the Fixed Mixer Positions .....	40
7.7 Misfire Correction .....	42
7.8 Analog and Binary Mixer Control .....	42
7.9 Error Detection .....	43
<b>8 Settings via WinScope .....</b>	<b>44</b>
8.1 WinScope System Requirements .....	44
8.2 Executing WinScope.....	44
8.3 Activating WinScope.....	45
8.4 Main View.....	46
8.4.1 Menu Bar and Toolbar .....	48
8.4.2 Establishing A Connection to the EmCons .....	50
8.5 Messages Window.....	51
8.6 Setpoints Window .....	52
8.6.1 Toolbar .....	55
8.6.2 Password Protection .....	56
8.7 Sensor Chars Group.....	57
8.7.1 Signal Processing at the Sensor Inputs .....	58
8.7.2 Error Detection at Sensor Inputs .....	62
8.7.3 Configuring Mixer Feedback Input .....	63
8.7.4 Configuring Engine Power Input.....	64
8.7.5 Configuring MAP Input .....	64
8.7.6 Configuring MAT Input .....	65
8.7.7 Configuring %CH <sub>4</sub> Input.....	65
8.7.8 Setting the Characteristic for the Methane Content Adjustment.....	66
8.8 Control Group .....	67
8.8.1 Setting Fixed Mixer Positions .....	68
8.8.2 Configuring Manifold Pressure Characteristic .....	69
8.8.3 Setting Control Parameters of the Power-Dependent Mixture Control.....	72
8.8.4 Setting Mixture Control Mode .....	72
8.8.5 Setting Manual Mixer Position .....	73
8.8.6 Setting Position Control .....	73
8.8.7 Setting the Methane Content Adjustment Mode.....	74
8.9 Protections Group .....	75
8.9.1 Setting Misfire Correction .....	76
8.9.2 Setting Manifold Pressure Control.....	76

<b>8.9.3</b>	Setting Control of MAP Input .....	76
<b>8.9.4</b>	Setting Manifold Air Temperature Control .....	77
<b>8.10</b>	CAN Comm Group .....	77
<b>8.11</b>	Channels Window.....	78
<b>8.11.1</b>	Toolbar .....	80
<b>8.11.2</b>	Adding Channels .....	82
<b>8.11.3</b>	Editing Channels .....	85
<b>8.12</b>	Period Window .....	86
<b>8.13</b>	Chart Window .....	88
<b>8.13.1</b>	Toolbar .....	90
<b>8.13.2</b>	Setting Axes Scaling .....	95
<b>8.14</b>	Options Window .....	96
<b>9</b>	<b>Operation .....</b>	<b>98</b>
<b>9.1</b>	Start-up .....	98
<b>9.2</b>	Configuring Mixture Control .....	99
<b>9.3</b>	Shutdown .....	101
<b>10</b>	<b>Faults .....</b>	<b>102</b>
<b>10.1</b>	Error Overview.....	102
<b>10.2</b>	Acknowledging Errors .....	104
<b>10.3</b>	Possible Faults .....	106
<b>10.4</b>	Customer Service Information .....	107
<b>10.5</b>	Returning Equipment for Repair / Inspection .....	107
<b>10.6</b>	Instructions for Packaging the Equipment .....	107
<b>11</b>	<b>Maintenance.....</b>	<b>108</b>
<b>11.1</b>	Maintenance Instructions .....	108
<b>11.2</b>	Spare Parts and Accessories .....	108
<b>12</b>	<b>Index .....</b>	<b>109</b>

# 1 GENERAL INFORMATION

Read through this operating manual carefully before use and become familiar with the machine. Installation and start-up should not be carried out before reading and understanding this document. Keep this manual readily available so that you can reference it as needed.

## 1.1 What Is the Purpose of this Operating Manual?

This manual serves as an aid for the installation and operation of the product and supports the technical staff with all operating and maintenance tasks to be performed. Furthermore, this manual is aimed at preventing dangers to life and health of the user and third parties.

## 1.2 Who Is this Operating Manual Targeted to?

The operating manual provides a code of conduct for personnel tasked with the set-up, operation, maintenance, and repair of gas engines. A certain level of technical knowledge with respect to the operation of gas engines and basic knowledge of electronic ignition systems are necessary. Persons who are only authorized to operate the gas engine shall be trained by the operating company and shall be expressly instructed concerning potential hazards.

## 1.3 Which Symbols Are Used in the Operating Manual?

The following symbols are used in this manual and must be observed:



### Example

This symbol indicates examples, which point out necessary handling steps and techniques. In addition, you receive additional information from the examples, which will increase your knowledge.



### Notice

This symbol indicates important notices for the user. Follow these. In addition, this symbol is used for overviews that give you a summary of the necessary work steps.



### Warning

This symbol indicates warnings for possible risks of property damage or risks to health. Read these warning notices carefully and take the mentioned precautionary measures.



### Danger

This symbol indicates warnings for danger to life, especially due to high voltage. Read these warning notices carefully and take the mentioned precautionary measures.

## 1.4 Which Abbreviations/Acronyms Are Used in the Operating Manual?

In the manual or the user interface, the following abbreviations / acronyms are used.

Abb.	Term	Description	Explanation
CAN bus	Controller Area Network Bus	Bus for control devices / networks	Asynchronous serial connection system for linking control units
CE	Conformité Européenne	Conformity with EU directives	Mark based on EU legislation for certain products in conjunction with product safety
CH <sub>4</sub>	Methane	Abbreviation for methane derived from the chemical empirical formula CH <sub>4</sub>	Natural combustible gas, which forms the main constituent of natural gas.
CSA	Canadian Standards Association		Organization that defines standards, inspects products for safety compliance, and issues pertinent certifications.
DC	Direct Current	Direct current	
EMC	Electromagnetic Compatibility		Compatibility of electrical or electronic equipment items with their surroundings
EMS	EmCon5 settings file		WinScope file format for saving configuration parameters
ESD	Electrostatic Discharge	Electrostatic discharge	
GCB	Generator Circuit Breaker	Generator circuit breaker	
LED	Light Emitting Diode	Light emitting diode	Light emitting electronic semi-conductor
MAP	Manifold Absolute Pressure	Manifold absolute pressure	

# 1 GENERAL INFORMATION

Abb.	Term	Description	Explanation
MAT	Manifold Air Temperature	Manifold air temperature	
MCB	Mains Circuit Breaker	Mains circuit breaker	
PI	Proportional Integral	Proportional, integral	
SDT	WinScope data file		WinScope file format for saving runtime data
SHN	WinScope channel file		WinScope file format for saving channel lists
USB	Universal Serial Bus		Serial connection system to link a computer to external devices



## 2 SAFETY INSTRUCTIONS

### 2.1 General Safety Instructions

MOTORTECH equipment is manufactured as state of the art and therefore safe and reliable to operate. Nevertheless the equipment can cause risks or damage can occur, if the following instructions are not complied with:

- The gas engine must only be operated by trained and authorized personnel.
- Operate the equipment only within the parameters specified in the technical data.
- Use the equipment correctly and for its intended use only.
- Never apply force.
- For all work such as installation, conversion, adaptation, maintenance, and repair, all equipment must be disconnected from the mains and secured against unintentional reactivation.
- Perform only such maintenance and repair work as is described in this operating manual, and follow the instructions given while working. For maintenance of the equipment, only use spare parts supplied by MOTORTECH. Further work must only be performed by personnel authorized by MOTORTECH. Non-compliance with the instructions will void any warranties for the proper function of the equipment as well as the responsibility for the validity of the certifications.
- Safety devices must not be dismantled or disabled.
- Avoid all activities that can impair the function of the equipment.
- Operate the equipment only while it is in proper condition.
- Investigate all changes detected while operating the gas engine or ignition system.
- Ensure compliance with all laws, directives and regulations applicable to the operation of your system, including such not expressly stated herein.
- If the gas-carrying parts of the system are not entirely tight, gas may escape and result in an explosion hazard. Upon completion of all assembly works, always check the system's tightness.
- Always ensure adequate ventilation of the engine compartment.
- Ensure a safe position at the gas engine.

### 2.2 Electrostatic Discharge Hazards

Electronic equipment is sensitive to static electricity. To protect these components from damage caused by static electricity, special precautions must be taken to minimize or prevent electrostatic discharge.

Observe these safety precautions while you work with the equipment or in its vicinity.

- Before performing maintenance or repair work, ensure that the static electricity inherent to your body is discharged.
- Do not wear clothing made from synthetic materials to prevent static electricity from building up. Your clothing should therefore be made of cotton or cotton mix materials.

## 2 SAFETY INSTRUCTIONS

- Keep plastics such as vinyl and Styrofoam materials as far away from the control system, the modules, and the work environment as possible.
- Do not remove the circuit boards from the housing of the device.

### 2.3 Information on Electric Isolation

If ground and earth potential are not properly isolated, the following problems as well as others can occur:

- Electro magnetic interferences (e.g. ground loops)
- Signal corruption (e.g. of the analog voltage signal)
- Unwanted leakage currents

Therefore, earth potential and the negative pole of the power supply of all devices in the electric assembly that provide the option, should be connected separately. If possible, the negative pole of the power supply should only be connected to earth potential at one point in the entire system.

#### Wiring Example

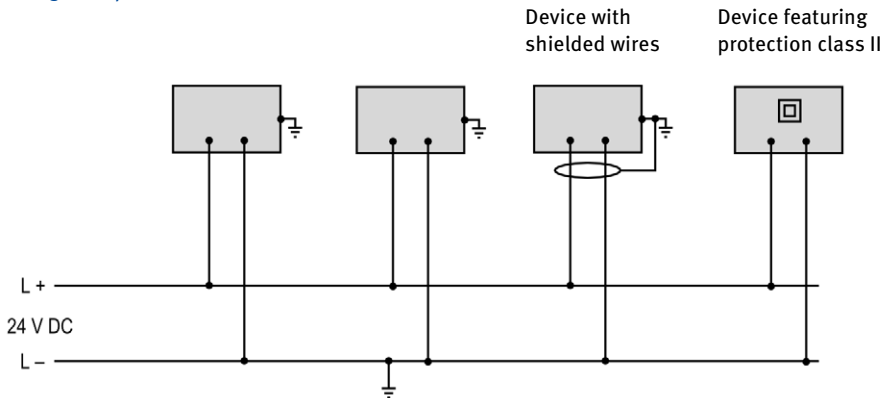



### Occurrence of ground loops

The devices shown in the following image do not feature the possibility to connect the earth potential and the negative pole of the power supply separated from each other. How ground loops are created.

A ground loop is a ground connection of an electric wiring assembly that is closed as a loop. Due to impedance (resistance  $R > 0$ ) of the loop, low-frequency interference currents can lead to an unwanted voltage drop in the signal path.

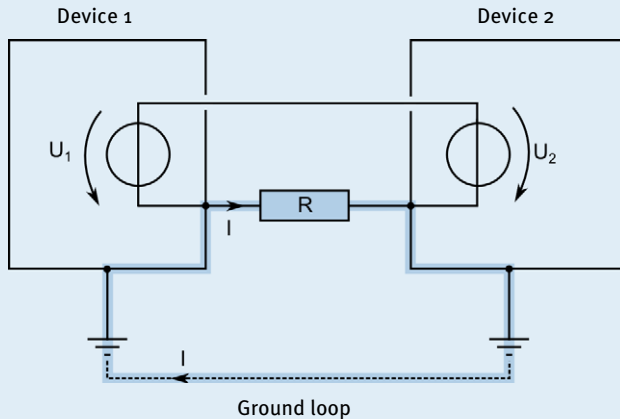

## 2.4 Special Safety Instructions for the Device



### Explosion hazard!

When the system is powered up, do not remove any connectors unless the system is not located in a potentially explosive atmosphere.



### Explosion hazard!

If the gas-carrying parts of the system are not entirely tight, gas may escape and result in an explosion hazard. Upon completion of all assembly works, always check the system's tightness.

All works involving gas-carrying parts must be executed by trained personnel only.

## 2 SAFETY INSTRUCTIONS



### Operational safety!

All screws of the connectors must be adequately tightened.



### Risk of destruction due to electrostatic discharge!

The emission controller EmCon5 may only be installed by specialized personnel who has been trained in handling ESD sensitive components and with due regard to relevant ESD standards. It must be installed into a control cabinet, and must comply with the ESD standard DIN EN 61340-5-1; VDE 0300-5-1:2008-07.

Damage caused by electrostatic discharge is not covered by warranty.



### Risk of burning!

The surfaces of the system may heat up to high temperatures.



### Risk of destruction!

Incorrect configuration of the EmCon5 may lead to serious damage to the engine. Consequently, the EmCon5 may only be configured by trained, authorized personnel. If you have any questions, contact your MOTORTECH contact partner (see *Customer Service Information* on page 107).

Damage caused by incorrect configuration is not covered by warranty.



### Risk of destruction!

Magnetic fields and heat occur when welding, which may damage or destroy the EmCon5. Therefore, pay attention to the following when welding:

- Disconnect all electrical connections to the EmCon5 prior to welding.
- Protect the EmCon5 against direct contact with the welding unit and magnetic fields, sparks and liquid metal.

## 2.5 Proper Disposal

After the expiration of its service life, MOTORTECH equipment can be disposed of with other commercial waste, or it may be returned to MOTORTECH. We will ensure its environmentally friendly disposal.

## 3 INTENDED USE

### 3.1 Functional Description

The emission controller EmCon5 adjusts the optimal air/fuel ratio for a turbo-charged lean-burn engine so that nitrogen oxide emissions remain low and misfires are avoided in the engine.

The EmCon5 calculates the optimal air/fuel ratio via the manifold pressure (*MAP*), the manifold air temperature (*MAT*) and the engine power (*Engine Power*). It controls the air/fuel ratio via a connected air/gas mixer, so that the optimal air/fuel ratio is achieved for every load.

If the gen-set is operated parallel to a grid, the power-dependent air/fuel ratio control of the EmCon5 can be limited to parallel operation.

Fixed mixer positions can be configured for an optimal air/fuel ratio upon engine start, when idling and when running with a load below the power-dependent control range. To facilitate operation with two types of gas or gas qualities, two configurable sets of fixed mixer positions are available. Depending on the signals at the binary inputs, for example from a master control or switches connected to it, the EmCon5 drives to the fixed mixer positions.

The fixed mixer positions can be adjusted for further optimization to the methane content (*%CH<sub>4</sub>*) of the inflowing gas.

Analog sensor inputs are available that can be adjusted to different input quantities and signal spans for the measurands manifold pressure, manifold air temperature, engine power, methane content and mixer feedback (*Mixer Feedback*).

Moreover, the EmCon5 checks compliance with the permissible manifold air temperature and permissible manifold pressure, the signals of the measurands to the analog inputs and the position of the air/gas mixer reported back. The EmCon5 signals error states via LEDs on the device and signals at the binary outputs.

If misfires are signaled to the EmCon5 via an external device, the manifold pressure can be corrected.

The configuration of the EmCon5 is done via the computer software WinScope. The configuration can be saved in a file with WinScope. Through displaying, recording and storing of runtime data, WinScope in addition permits monitoring and recording of the ongoing operation.

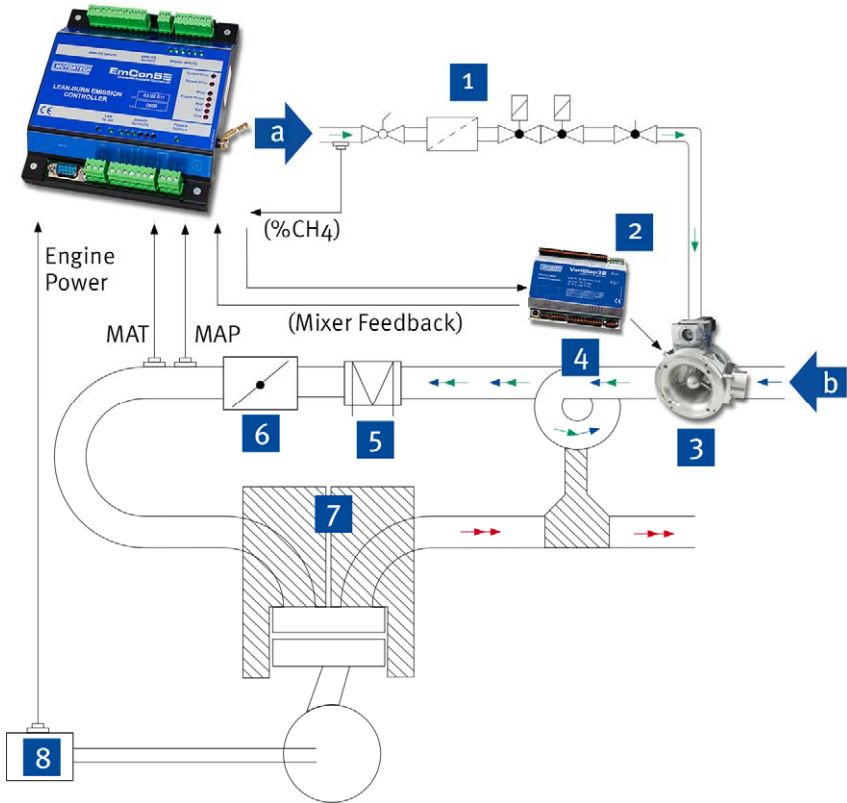

Position	Designation	Position	Designation
1	Gas train	a	Gas
2	Stepper motor driver	b	Air
3	Air/gas mixer		
4	Turbocharger		
5	Mixture cooler		
6	Throttle		
7	Gas engine		
8	Generator		

### 3 INTENDED USE

#### Regulation of the Air/Fuel Ratio in Lean-Burn Engines

Lean-burn engines operate using a "lean" air/fuel mixture, in which more air is added to the mixture than required for combustion in the cylinder. As a result, the air/fuel ratio of a lean-burn engine is always greater than 1  $\lambda$  (lambda). The advantage of the lean mode of an engine is that the combustion temperature remains relatively low and less nitrogen oxide arises.

The optimal air/fuel ratio changes depending on the engine power (*Engine Power*). An excessively lean air/fuel mixture leads to misfires in the engine (*misfire limit line*). An excessively rich air/fuel mixture leads to a rise in nitrogen oxide emissions (*Nitrogen oxide emissions line*) and from a certain engine power, this may also lead to uncontrolled explosions of the residual mixture amount, so-called "knocking".

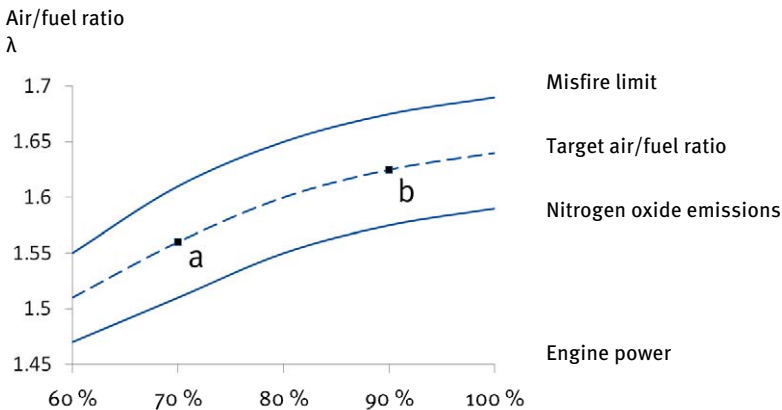

More air must be introduced into the air/fuel mixture for an optimal air/fuel ratio when the engine power increases. Thus, the lambda value also rises with increasing engine power.

However, the emission controller EmCon5 does not measure the current air/fuel ratio via a lambda sensor, but instead determines it via the manifold pressure (*MAP*). In doing so, it makes use of the following relationship: If the air/fuel ratio changes at a constant engine power, constant manifold air temperature and constant fuel value, the manifold pressure in the manifold in front of the intake valve changes correspondingly. In this way, a power-dependent target value of the manifold pressure can be assigned to each power-dependent target value of the air/fuel ratio.

In this regard, it must be borne in mind that the characteristics for the air/fuel ratio and the manifold pressure differ from engine to engine. Therefore, they must be determined for each engine before the EmCon5 can be used.



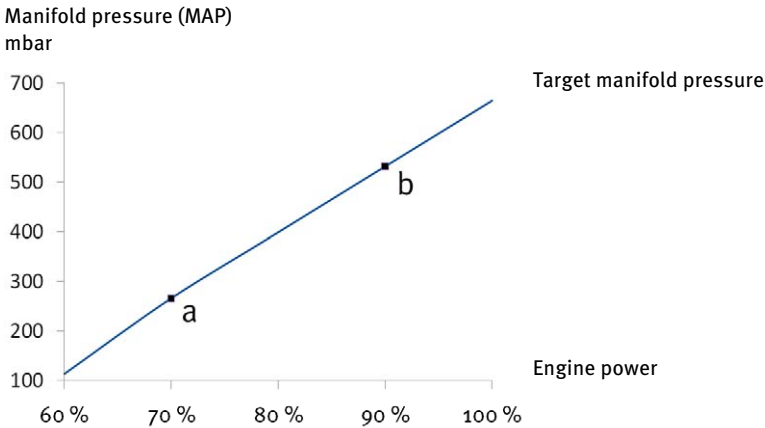

Consequently, the EmCon5 achieves the optimal air/fuel ratio by controlling the air/fuel mixture via an air/gas mixer and in this creating the manifold pressure that corresponds to the optimal air/fuel ratio for a particular engine power.

Pos.	Engine power	Target air/fuel ratio	Target manifold pressure
a	70 %	1.56 λ	266 mbar
b	90 %	1.63 λ	532 mbar

The reciprocal relationship between manifold pressure and air/fuel ratio depends on the manifold air temperature (*MAT*). If the manifold air temperature in the manifold in front of the inlet valve changes, the EmCon5 must adjust the manifold pressure characteristic accordingly.

The reciprocal relationship between manifold pressure and air/fuel ratio also depends on the fuel value of the gas. Since the normal fuel value fluctuations are negligible, the EmCon5 does not evaluate them for the power-dependent air/fuel mixture control.

However, changes in the air/fuel ratio do affect the engine power. Consequently, the engine has to be fitted with a power-controlled throttle that keeps the engine power constant.

## 3 INTENDED USE

### 3.2 Applications

The EmCon5 is intended for stationary turbo-charged lean-burn gas engines with constant speed. An absolute pressure sensor and a Pt100 temperature sensor are required for proper operation. The EmCon5 can be operated independently without a master control.

Any use other than the one described in the operating manual shall be considered improper use and will result in the voiding of all warranties.

## 4 PRODUCT DESCRIPTION

### 4.1 Technical Data

#### 4.1.1 Certifications

The emission controller EmCon5 is certified according to the following directives:

##### CE

- EMC Directive 2004/108/EC
  - Immunity for residential, commercial and light-industrial environments as per DIN EN 61000-6-1 and DIN EN 61000-6-3
  - Immunity for industrial environments as per DIN EN 61000-6-2 and DIN EN 61000-6-4
- Low Voltage Directive 2006/95/EC
  - Safety requirements for electrical equipment for measurement, control and laboratory use as per DIN EN 61010-1:2003

## 4 PRODUCT DESCRIPTION

### CE DECLARATION OF CONFORMITY

The company: **MOTORTECH GmbH**  
**Hogrevestrasse 21 - 23**  
**29223 Celle**

declares that the products: **EmCon5 Emission Controller**

Intended purpose: **to be used on engines**

complies with the provisions of the following EC-Directives:  
**EMC Directive 2004/108/EC**  
**Low Voltage Directive 2006/95/EC**

under consideration of following standards:  
**DIN EN 61010-1:2003**  
**DIN EN 61000-6-1, DIN EN 61000-6-2**  
**DIN EN 61000-6-3, DIN EN 61000-6-4**

The marking of the product is: **P/N 63.02.011**

This declaration is submitted by:  
Name: Florian Virchow Professional status: Managing Director

Celle, 01.04.2011  
City, Date

  
legally binding signature

### 4.1.2 Mechanical Data

The emission controller EmCon5 has the following mechanical characteristics:

Feature	Value
Dimensions	163 mm x 161 mm x 52 mm (6.42" x 6.34" x 2.05") (length x width x height)
Weight	590 g (1.31 lbs)
Shape of device	See section <i>Overview Drawings</i> on page 23
Mechanical environmental conditions	Protection: IP20
Climatic environmental conditions	-30 °C to +70 °C max. (-22 °F to +158 °F) Max. 95 % humidity without condensation up to 2000 m (6562') above sea level

### 4.1.3 Electrical Data

The emission controller EmCon5 has the following electrical characteristics:

Feature	Value
Power consumption	Max. 2.4 W
Power supply	8 V DC to 36 V DC
Required current	Max. 100 mA at 24 V

#### Electrical Data for Inputs and Outputs

The inputs and outputs of the emission controller have the following electrical data:

Inputs and outputs	Values/characteristics
Binary outputs	Grounded Input impedance: 4.7 kΩ Input voltage: 0 to 24 V DC Save high level: voltages above 7 V Save low level: voltages below 1.5 V
Binary outputs	Open collector Maximum output current: 500 mA Open output: max. current < 50 μA Closed output: resistance < 0.15 Ω

## 4 PRODUCT DESCRIPTION

Inputs and outputs	Values/characteristics
Analog inputs	<p>Not galvanically isolated</p> <p>Input signal for mixer feedback:</p> <ul style="list-style-type: none"><li>– Voltage: 0 to 12.5 V</li><li>– Current: 0 to 25 mA</li><li>– Resistance: 0 to 2.5 k<math>\Omega</math></li></ul> <p>Input signal for engine power, manifold air temperature, manifold pressure, methane content:</p> <ul style="list-style-type: none"><li>– Voltage: 0 to 1.25 V</li><li>– Current: 0 to 25 mA</li><li>– Resistance: 0 to 250 <math>\Omega</math></li></ul> <p>Voltage precision: <math>\pm 1\%</math> (entire range)</p> <p>Current precision: <math>\pm 1\%</math> (entire range)</p> <p>Resistance precision: <math>\pm 2\%</math> at 240 <math>\Omega</math></p>
Analog output	<p>Output voltage: 0 to 20 mA</p> <p>Voltage precision: <math>\pm 2\%</math> (entire range)</p> <p>Output current: 0 to 10 V</p> <p>Current precision: <math>\pm 1\%</math> (entire range)</p>

### 4.1.4 Interfaces

#### CAN Bus Interface

- Galvanically isolated
- Transmission rate: 250 kBd
- Maximum cable length: 200 m
- Impedance: 120  $\Omega$
- Cable type: two-core, shielded

#### RS232 Interface

- Data rate: 19,200 Baud
- Maximum lead length: 10 m
- Plug connection: D-SUB, 9-pole

## 4.1.5 Overview Drawings

### Dimensions

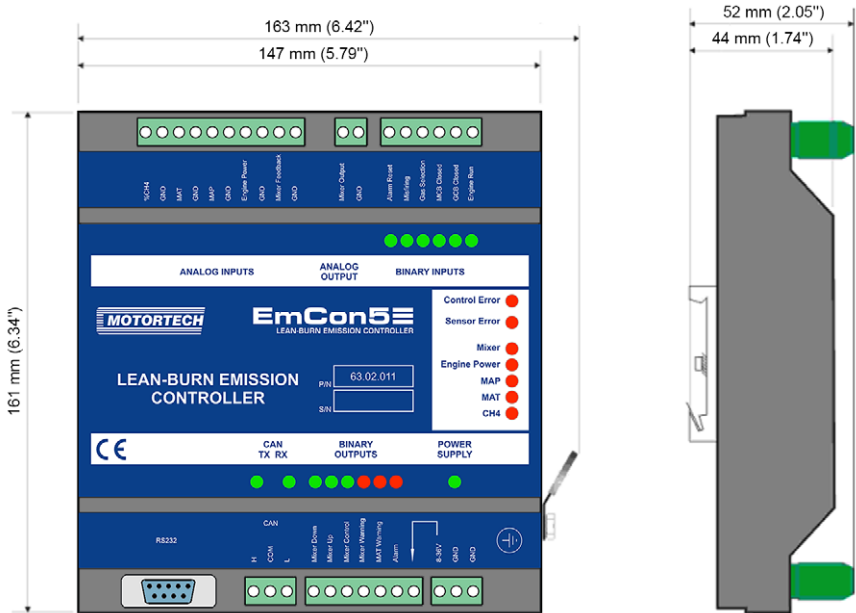

## 4 PRODUCT DESCRIPTION

### Ports/Connections and LEDs

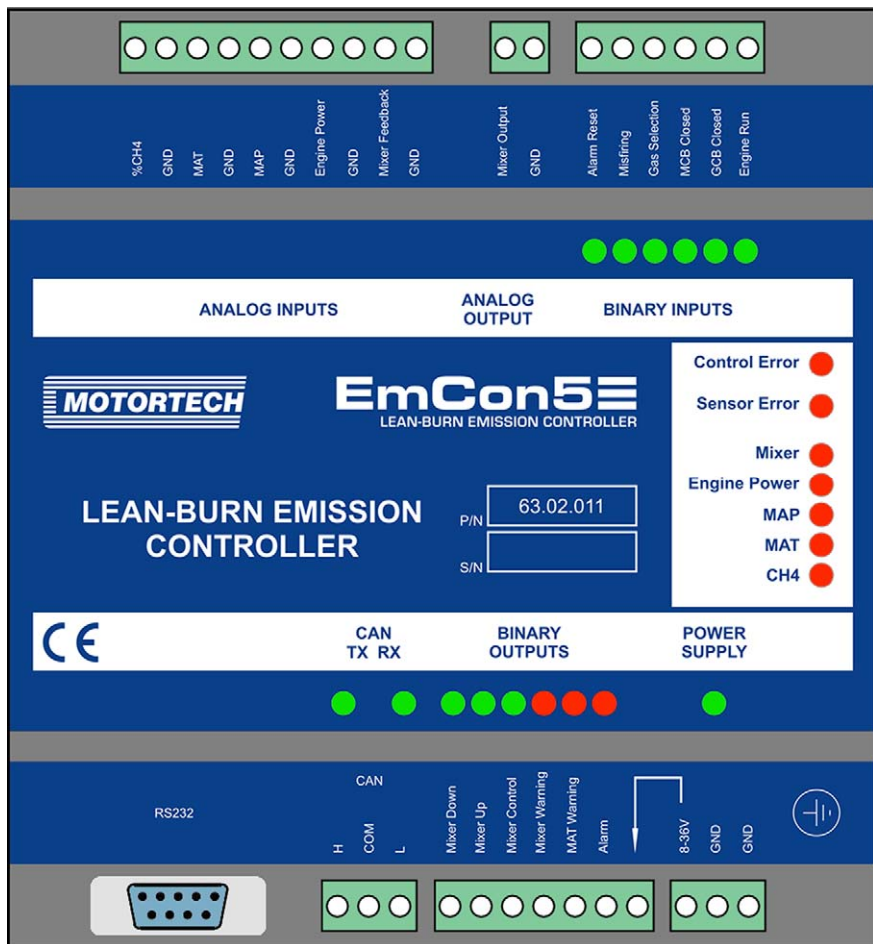



Designation	Function
ANALOG INPUTS	Inputs for the analog signals of the measurands methane content, manifold air temperature, manifold pressure, engine power and mixer feedback (see <i>Wiring – Analog Connections</i> on page 28).
ANALOG OUTPUT	Output that sends the targeted mixer position to the air/gas mixer as an analog signal (see <i>Set Jumpers</i> on page 29).
BINARY INPUTS	Inputs for the binary status and control signals (e. g. for error resetting or gas selection), that influence the behavior of the EmCon5. Closed inputs are indicated by the illumination of the relevant LEDs (see <i>Wiring – Binary Inputs</i> on page 31).
Control Error, Sensor Error, Mixer, Engine Power, MAP, MAT, CH <sub>4</sub>	LEDs for the display of error states (see <i>Error Overview</i> on page 102).
RS232	RS232 port for connecting the EmCon5 to a computer for configuration using WinScope (see <i>Establishing A Connection to the EmCon5</i> on page 50)
CAN	Port for communication via the CAN bus. Data transmission is signaled by the blinking LEDs TX and RX (TX=Data are being sent, RX=Data are being received). For more information on the CAN bus, see <i>Wiring – CAN Bus Interface</i> on page 32.
BINARY OUTPUTS	Binary outputs for the transmission of control signals to the connected control of the air/gas mixer and for indicating the power-dependent mixture control and error states on a master control or display. Closed outputs and indicated error states are signaled by illumination of the relevant LEDs (see <i>Wiring – Binary Outputs</i> on page 33).
POWER SUPPLY	Connection to the power supply. The LED is illuminated if the device is connected to the power supply (see <i>Wiring – Power Supply</i> on page 34).

### Product Identification

Designation	Description	Explanation
P/N	P/N number	Product number of the emission controller
S/N	S/N number	Serial number of the emission controller

# 5 INSTALLATION INSTRUCTIONS

## 5.1 Unpacking

Unpack the device, taking care not to damage it, and ensure that the operating manual is always stored with the emission controller and is easily accessible. Check the contents for completeness.

### Scope of Supply

The scope of supply of the EmCon5 emission controller consists of the following components:

- Emission controller EmCon5
- Storage device (USB flash drive or CD-ROM) with software for configuration and monitoring of the emission controller
- RS232 interface cable for connecting the emission controller to a computer
- Operating manual

## 5.2 Installation of the Emission Controller



### Risk of destruction!

The device must not be installed directly on or at the engine, as vibration and heat may cause damage to electronic components.



### Risk of destruction!

Make sure that the device is not covered and ensure sufficient circulation of air.



### Risk of destruction due to electrostatic discharge!

The emission controller EmCon5 may only be installed by specialized personnel who has been trained in handling ESD sensitive components and with due regard to relevant ESD standards. It must be installed into a control cabinet, and must comply with the ESD standard DIN EN 61340-5-1; VDE 0300-5-1:2008-07.

Damage caused by electrostatic discharge is not covered by warranty.

The EmCon5 emission controller is mounted on a DIN rail in the control cabinet. The installation location of the device must be selected so that the distance to the sensors installed on the pipes ensures a reliable signal transmission to the emission controller, and so that there is adequate space for maintenance and repair work. Also ensure adequate space for the connection wiring.

The mechanical specifications must always be complied with (refer to *Mechanical Data* on page 21).

Ground the device using the ground contact installed on the side. Ensure a flawless electrical connection for this purpose.

Installation locations where strong vibrations or ambient temperatures of below  $-30\text{ }^{\circ}\text{C}$  ( $-22\text{ }^{\circ}\text{F}$ ) or above  $+70\text{ }^{\circ}\text{C}$  ( $+158\text{ }^{\circ}\text{F}$ ) are present are not permissible and result in the warranty being voided.

### 5.3 Installation of Sensors



#### **Explosion hazard!**

If the gas-carrying parts of the system are not entirely tight, gas may escape and result in an explosion hazard. Upon completion of all assembly works, always check the system's tightness.

All works involving gas-carrying parts must be executed by trained personnel only.

Install the sensors in a pressure-free and disconnected state.

Sensors for manifold pressure (MAP) and manifold air temperature (MAT):

- The EmCon5 is designed for operation with an absolute pressure sensor and a Pt100 temperature sensor.
- Install both sensors on the manifold behind the throttle.

Optional methane sensor (%CH<sub>4</sub>):

- Install the methane sensor on the gas supply line leading to the air/gas mixer before the gas valves of the gas pressure control system.

The installation locations of the sensors must have adequate mechanical strength and may not exceed the specified temperature ranges. Observe the tightening torques as specified by the manufacturer. Comply with the pertinent regulations for wiring. Upon completion of all assembly work, check the system's tightness.

# 6 WIRING OF THE DEVICE

## 6.1 Wiring – Analog Connections

### Wiring Example with Analog Mixer Control

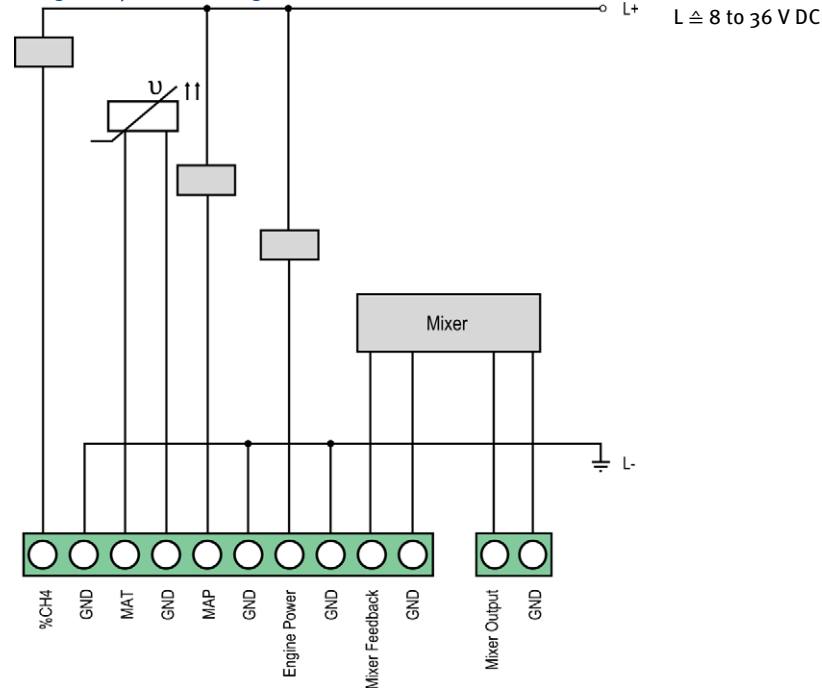

#### Analog Inputs

For each of the five inputs, the input quantity is determined via a jumper on the EmCon5 board (see section *Set Jumpers* on page 29).

Designation	Function
%CH <sub>4</sub>	Input for the measured value signal of the methane sensor
GND	
MAT	Input for the measured value signal of the manifold air temperature sensor
GND	
MAP	Input for the measured value signal of the manifold pressure sensor
GND	
Engine Power	Input for the measured value signal of the engine power measurement
GND	

Designation	Function
Mixer Feedback	Input for the position feedback of the air/gas mixer ( <i>Mixer</i> )
GND	

### Analog Output

The output quantity of the analog output is determined via a jumper on the EmCon5 board (see section *Set Jumpers* on page 29).

Designation	Function
Mixer Output	Analog output which sends the targeted mixer position as an analog signal to the control of the air/gas mixer ( <i>Mixer</i> ).
GND	

## 6.1.1 Set Jumpers

### Preparation

The upper housing cover must first be removed to set the jumpers or check their position. For this purpose remove the Phoenix clamps from the connections. Loosen and then remove the four screws at the corners of the housing cover. Remove the housing cover. After the jumpers have been set or their position checked, screw the housing cover back on and put the Phoenix clamps back in place.

### Jumper Positions

The jumpers are placed on the EmCon5 board directly in front of each output and are only visible if the upper housing cover has been removed. In as-delivered state, the jumpers of the EmCon5 are set as follows:

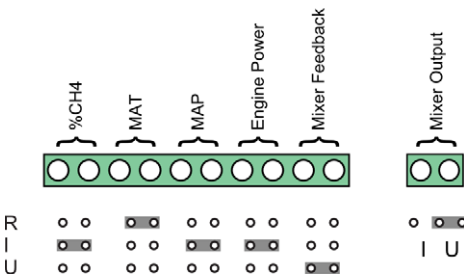

## 6 WIRING OF THE DEVICE

### Analog Inputs

The input quantity is determined via the jumper position for each of the analog inputs. The input quantity can be resistance (R), current (I) or voltage (U). Depending on the input, the following signal levels can be processed:

Input	Signal range at jumper position		
	R (resistance)	I (current)	U (voltage)
Mixer Feedback	0 – 2.5 k $\Omega$	0 – 25 mA	0 – 12.5 V
Engine Power	0 – 250 $\Omega$		0 – 1.25 V
MAP			
MAT			
%CH <sub>4</sub>			



#### Risk of destruction!

Excessive voltage or current at the inputs destroys the EmCon5. Compliance with the ranges stated is essential.

### Analog Output

The output quantity is determined via the jumper position for the analog output *Mixer Output*. The output quantity can be current (I) or voltage (U). The EmCon5 issues the following signal levels depending on the jumper position:

Output	Signal range at jumper position	
	I (current)	U (voltage)
Mixer Output	0 – 20 mA	0 – 10 V

## 6.2 Wiring – Binary Inputs

### Wiring Example

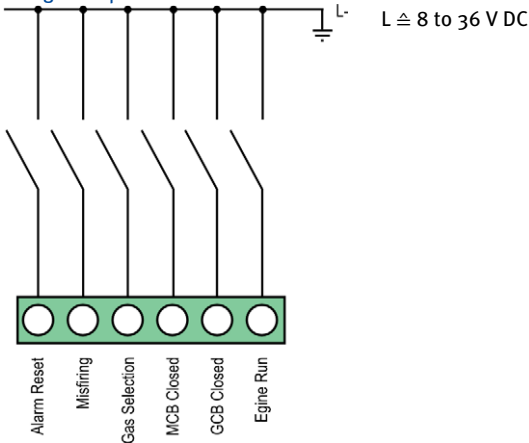

Designation	Function
Alarm Reset	Used to reset error messages. If the input is closed for at least 100 ms, resetting is triggered (see <i>Acknowledging Errors</i> on page 104).
Misfiring	Input for misfire detection. A closed input signals to the EmCon5 that misfires are occurring in the engine (see <i>Misfire Correction</i> on page 42).
Gas Selection	Used to switch between the mixer position sets. When the input is open, the EmCon5 uses position set 1, when the input is closed position set 2 (see <i>Configurable Fixed Mixer Position Sets</i> on page 39).
MCB Closed	Connection for the feedback signal of the mains circuit breaker. Used in mixture control mode <i>AUT-PAR</i> to signal parallel operation (input closed) and island operation (input open). For more information see <i>Setting Mixture Control Mode</i> on page 72.
GCB Closed	Connection for the feedback signal of the generator circuit breaker. When the input is closed, the EmCon5 drives to the low power position ( <i>Low Pwr pos</i> ) or starts the power-dependent air/fuel mixture control (see <i>Overview of Functions</i> on page 35).
Engine Run	Signals that the engine is running. When the input is closed, the EmCon5 drives to the run position ( <i>Run pos</i> ).

# 6 WIRING OF THE DEVICE

## 6.3 Wiring – CAN Bus Interface

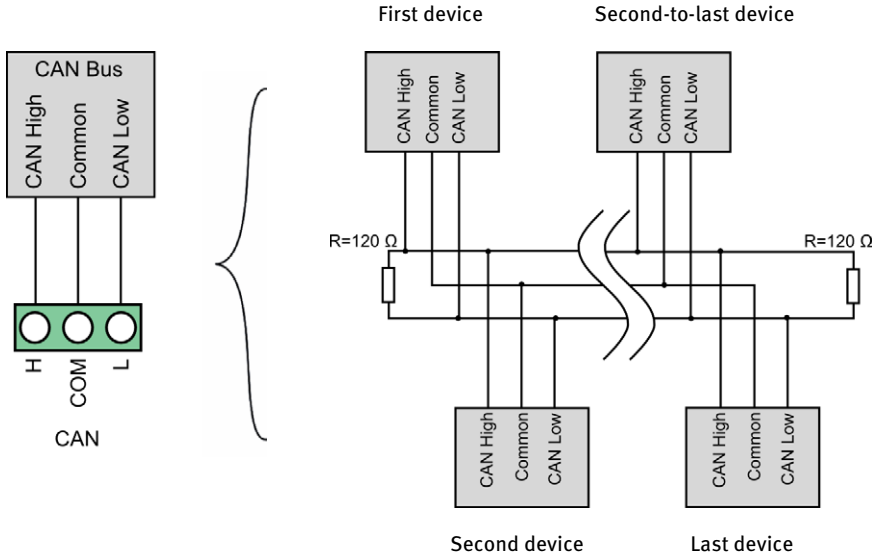

### CAN bus wiring

Note the following when connecting the CAN bus:

- A maximum of 110 devices can be connected to a CAN bus.
- The maximum wire length is 200 m (656') for a transmission rate of 250 kBd.
- Each bus end must be fitted with a terminating resistor of 120 Ω (see drawing).



## 6.4 Wiring – Binary Outputs

Wiring Example with Connected Binary Mixer Control (*Mixer*) and Four Relays

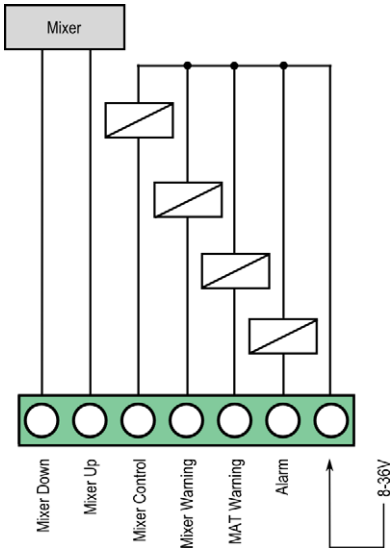

Designation	Function
Mixer Down	The output is closed if the mixer position reported back is above the targeted mixer position and exceeds a defined tolerance. Can be used as binary control signal in the direction closed (see <i>Setting Position Control</i> on page 73).
Mixer Up	The output is closed if the mixer position reported back is below the targeted mixer position and exceeds a defined tolerance. Can be used as binary control signal in the direction open (see <i>Setting Position Control</i> on page 73).
Mixer Control	Signals by a closed output that the power-dependent air/fuel mixture control of the EmCon5 is active.
Mixer Warning	Signals an error in the mixer control: The output is closed if the distance between the reported and the targeted mixer position exceeds a set tolerance for a certain amount of time (see <i>Setting Position Control</i> on page 73).
MAT Warning	Signals in the event of a closed input an exceedance of the configurable maximum permissible manifold air temperature (see <i>Setting Manifold Air Temperature Control</i> on page 77).

# 6 WIRING OF THE DEVICE

Designation	Function
Alarm	Signals in the event of a closed input that an operating error exists (see <i>Error Overview</i> on page 102).
8-36V	Output for the power supply, which if necessary can be used by units connected to the binary outputs (e. g. relays).

## 6.5 Wiring – Power Supply

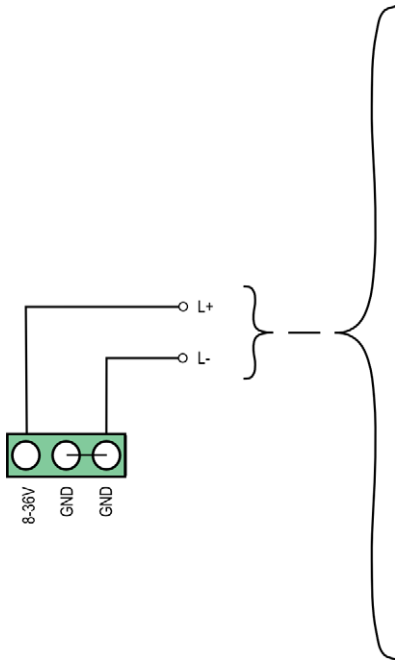

Variations			
1	Battery	Generator	Control unit
2	Power supply		
3	Battery	Charger	

# 7 FUNCTIONS

## 7.1 Overview of Functions

### Functional Diagram

The following diagram illustrates the mode of operation of the emission controller EmCon5. For error detection, the manifold pressure control is presented as an example. The individual functions are explained in more detail in the sections below.

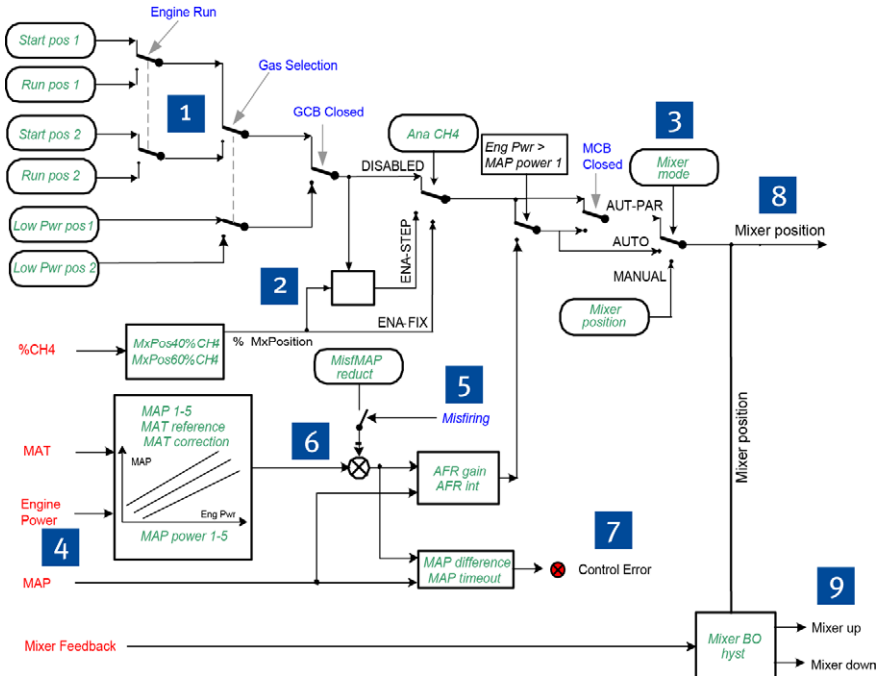

Pos.	Description	Explanation
1	Fixed mixer positions	See <i>Configurable Fixed Mixer Position Sets</i> on page 39
2	Methane content adjustment of the fixed mixer positions	See <i>Methane Content Adjustment of the Fixed Mixer Positions</i> on page 40
3	Mixture control mode	See <i>Mixture Control Modes</i> on page 37
4	Sensor inputs	See <i>Configurable Sensor Inputs</i> on page 40
5	External misfire detection	See <i>Misfire Correction</i> on page 42
6	Power-dependent air/fuel mixture control	See <i>Power-Dependent Air/Fuel Mixture Control</i> on page 38

# 7 FUNCTIONS

Pos.	Description	Explanation
7	Error signaling	See <i>Error Detection</i> on page 43
8	Analog mixer control	See <i>Analog and Binary Mixer Control</i> on page 42
9	Binary mixer control	

## Time Control Diagram

As an example, the following time control diagram illustrates the control behavior of the EmCon5 in mixture control mode *AUTOMATIC* and with closed mains circuit breaker (input *MCB Closed* closed) in mixture control mode *AUT-PAR*. Read the section *Mixture Control Modes* on page 37 for more information on the mixture control modes.

Mixer position

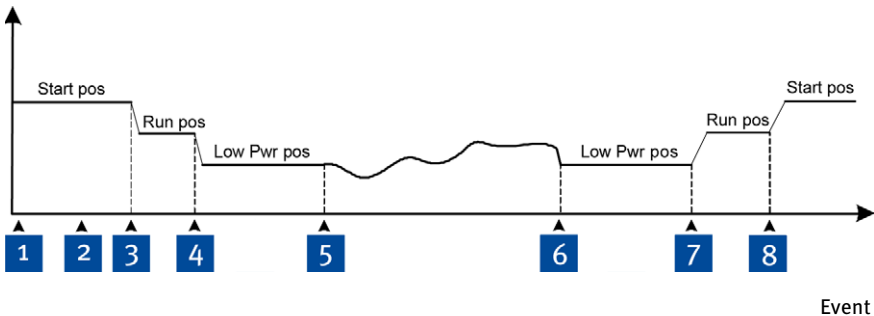

Event

Pos.	Event	Explanation
1	Engine off	The <i>Engine Run</i> and <i>GCB Closed</i> inputs are open. The mixer is in start position ( <i>Start pos</i> ).
2	Engine start	The engine is started.
3	<i>Engine Run</i> input closed	The closed <i>Engine Run</i> input signals to the EmCon5 that the engine is running. The EmCon5 drives the mixer to the run position ( <i>Run pos</i> ).
4	<i>GCB Closed</i> input closed	The closed <i>GCB Closed</i> input signals to the EmCon5 that the generator circuit breaker has been closed. The EmCon5 drives the mixer to the low power position ( <i>Low Pwr pos</i> ).
5	<i>MAP power 1</i> reached/ exceeded	The power-dependent air/fuel mixture control is activated as soon as the current power lies within the power-dependent control range.

Pos.	Event	Explanation
6	<i>MAP power 1</i> not met	If the current power falls below the power-dependent control range, the power-dependent air/fuel mixture control is disabled and the EmCon5 drives the mixer to the low power position ( <i>Low Pwr pos</i> ).
7	<i>GCB Closed</i> input open	The generator circuit breaker is open. The EmCon5 drives the mixer to the run position ( <i>Run pos</i> ).
8	<i>Engine Run</i> input open	The open <i>Engine Run</i> input signals to the EmCon5 that the engine has been stopped. The EmCon5 drives the mixer to the start position ( <i>Start pos</i> ).

## 7.2 Mixture Control Modes

The EmCon5 can be operated in the following mixture control modes:

- Manual mode (*MANUAL*)
- Automatic mode (*AUTOMATIC*)
- Automatic mode with power-dependent air/fuel mixture control in parallel operation (*AUT-PAR*)

### MANUAL

In the mixer control mode *MANUAL*, the targeted mixer position is defined solely by the parameter *Mixer position*. The EmCon5 does not evaluate the binary input signals or the sensor inputs to position the mixer.

### AUTOMATIC

In the mixer control mode *AUTOMATIC*, the EmCon5 evaluates the signals of the binary inputs and sensor inputs to position the mixer. The EmCon5 drives to the configured fixed mixer positions (start position, run position, low power position) depending on the signals on the binary inputs. In addition, when the generator circuit breaker (input *GCB Closed*) is closed, the power-dependent air/fuel mixture control is active provided the engine power reported back is within the power-dependent control range.

The position of the mains circuit breaker (input *MCB Closed*) for signaling parallel operation is not evaluated by the EmCon5 in this mode.

### AUT-PAR

This mode corresponds to the mixture control mode *AUTOMATIC*. However in the *AUT-PAR* mode the EmCon5 restricts the power-dependent air/fuel mixture control to parallel operation. The EmCon5 evaluates the position of the mains circuit breaker (input *MCB Closed*) for this purpose: A closed input *MCB Closed* signals parallel operation, an open input island operation. In island operation, the EmCon5 always drives to the low power position when the generator circuit breaker (input *GCB Closed* closed) is closed and the engine is running (input *Engine Run* closed).

# 7 FUNCTIONS

For example, the *AUT-PAR* mixture control mode can be used in cases in which the settings of the power-dependent air/fuel mixture control are not suitable for island operation. This allows you to ensure that the EmCon5 drives to a safe mixer position in island operation in the event of a power failure.

The mixture control mode is set via the WinScope software. The section *Setting Mixture Control Mode* on page 72 contains more information.

## 7.3 Power-Dependent Air/Fuel Mixture Control

The EmCon5 has an air/fuel mixture control that produces the optimal air/fuel ratio by controlling the manifold pressure depending on the engine power.

The EmCon5 determines an optimal target value for the manifold pressure depending on the engine power from a characteristic. The EmCon5 compares this target value with the current manifold pressure. If there is a deviation between both values, the emission controller changes the air/fuel mixture via the connected air/gas mixer until the manifold pressure in the manifold corresponds to the target value.

Two to five setpoints and the reference temperature of the characteristic can be defined for the manifold pressure characteristic. The manifold pressure characteristic defines the manifold pressure ( $MAP_x$ ) required for a certain engine power ( $MAP\ power_x$ ) for up to five setpoints. The EmCon5 performs a linear calculation to determine the values between two setpoints.

Manifold pressure ( $MAP$ )  
mbar

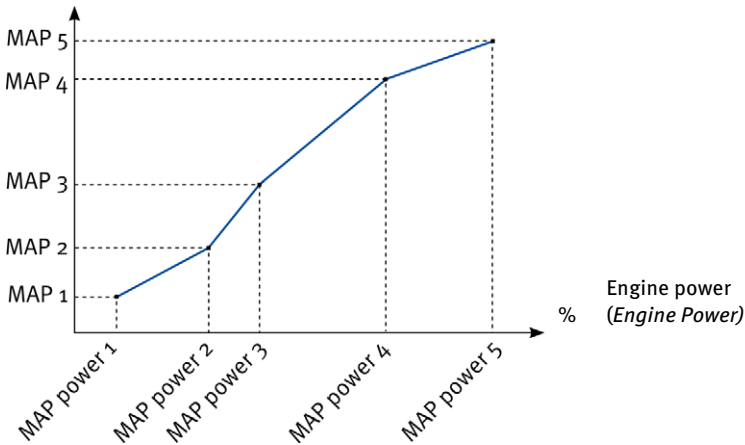

If the actual manifold air temperature in the manifold deviates from the reference temperature, the target manifold pressure to be achieved can be corrected proportionally by a definable factor depending on the size of the difference measured up to a particular value.

The power-dependent air/fuel mixture control of the EmCon5 kicks in as soon as the engine power is in the power-dependent control range. This control range begins with the first lower setpoint (*MAP power 1*). Below this limit, the EmCon5 drives the mixer to the low power position.

The EmCon5 signals that the power-dependent air/fuel mixture control is active by the illumination of the LED *Mixer Control* on the device and by the closed output *Mixer Control*.

The power-dependent air/fuel mixture control is available in the mixture control modes *AUTOMATIC* and *AUT-PAR*. It is restricted to parallel operation in the mixture control mode *AUT-PAR*. Read the section *Mixture Control Modes* on page 37 for more information on the mixture control modes.

Read the section *Configuring Manifold Pressure Characteristic* on page 69 for information on configuring the manifold pressure characteristic.

## 7.4 Configurable Fixed Mixer Position Sets

The EmCon5 drives to the following configurable fixed mixer positions depending on the gen-set state signaled:

- Start position (*Start pos*): Position of the mixer at engine start and simultaneously rest position when the engine is not in operation.
- Run position (*Run pos*): Position of the mixer when running without load.
- Low power position (*Low Pwr pos*): Position of the mixer running with load below the power-dependent control range

You can set two sets of fixed mixer positions for operations using two types of gas or gas qualities. You can use the *Gas Selection* binary input to switch between the mixer position sets.

Position set	Gas Selection input	Mixer positions
1	open	<i>Start pos 1, Run pos 1, Low Pwr pos 1</i>
2	closed	<i>Start pos 2, Run pos 2, Low Pwr pos 2</i>

The fixed mixer position sets are set via the WinScope software. There is more information in the section *Setting Fixed Mixer Positions* on page 68.

## 7 FUNCTIONS

### 7.5 Configurable Sensor Inputs

The EmCon5 has analog sensor inputs for the measurands:

- Manifold pressure
- Manifold air temperature
- Methane content
- Engine power
- Mixer feedback

For each of the sensor inputs, jumpers on the EmCon5 board can be used to set the input quantity of the measured value signal. The measured values can be transmitted as:

- Resistance value
- Current value
- Voltage value

The signal and measured value range can be set for each of the inputs via the EmCon5. This allows the EmCon5 to be adjusted to various sensors and transducers.

The sensor inputs are configured using the WinScope software. There is more information in the section *Sensor Chars Group* on page 57.

### 7.6 Methane Content Adjustment of the Fixed Mixer Positions

To optimize engine start, idling and running without load, the fixed mixer positions can be made dependent on the methane content of the inflowing gas. In this way, the fixed mixer positions can be adjusted to the fluctuating methane contents of the inflowing gas.



The adjustment to the methane content takes place using a characteristic with two setpoints. You define the optimal mixer position for the engine start for a methane content of 40 % (Parameter  $MxPos_{40\%CH_4}$ ) and of 60 % (parameter  $MxPos_{60\%CH_4}$ ). The EmCon5 calculates the mixer position linearly for all other methane values and stores this calculated position internally in the parameter  $MxPos_{CH_4}$ .

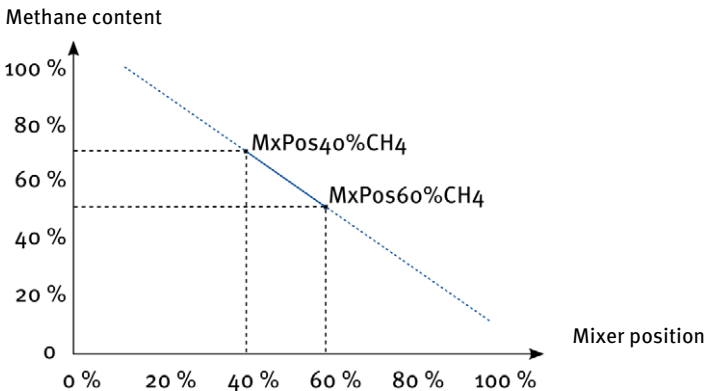

Two modes are available for the methane content adjustment of the fixed mixer positions:

- **ENA-FIX:** The EmCon5 determines the start position and run position using the characteristic. The EmCon5 drives to the low power position as defined in the configuration.
- **ENA-STEP:** The EmCon5 determines the fixed mixer positions using the characteristic ( $=MxPos_{CH_4}$ ). The EmCon5 shifts the run position and the low power position based on the configured difference to the start position.

Mixer position	Position determination in ENA-STEP mode
Start position	$MxPos_{CH_4}$
Run position	$MxPos_{CH_4} + (\text{run position} - \text{start position})$
Low power position	$MxPos_{CH_4} + (\text{low power position} - \text{start position})$

The adjustment of the fixed mixer positions to the methane content is configured with the WinScope software. There is more information in the sections *Setting the Characteristic for the Methane Content Adjustment* on page 66 and *Setting the Methane Content Adjustment Mode* on page 74.

## 7 FUNCTIONS

### 7.7 Misfire Correction

Using the binary input *Misfiring*, the status signal of an external misfire detection can be connected to the EmCon5 in order to adjust the calculated target value for the manifold pressure in power-dependent air/fuel mixture control when misfires occur. When the input *Misfiring* is connected, the manifold pressure target value is changed by a fixed configurable correction value. In this way the mixture can for example be enriched when misfires occur.

The correction value for the manifold pressure target value is set via the WinScope software. There is more information in the section *Setting Misfire Correction* on page 76.

### 7.8 Analog and Binary Mixer Control

On the EmCon5, an analog output and two binary outputs are available for position and control signals to a connected mixture control.

#### Analog Mixer Control

The current targeted position is issued as position signal at the analog output *Mixer Output*. The signal can be output as:

- Current value (0 to 20 mA)
- Voltage value (0 to 10 V)

The analog signal output is selected via a jumper on the EmCon5 board. The level of the signal is in this regard proportional to the targeted mixer position. A level of 20 mA or 10 V corresponds to the position open (100 %), a level of 0 mA or 0 V to the position closed (0 %). The *Mixer Feedback* sensor input is not required for the analog control.

For more information on jumper settings of the output *Mixer Output* read the section *Set Jumpers* on page 29.

#### Binary Mixer Control

At the binary outputs *Mixer Up* and *Mixer Down*, a closed output signals the direction of movement of the mixer until the target position has been reached and reported back correspondingly via the analog input *Mixer Feedback*. A movement in the closed direction is signaled via *Mixer Down*, a movement in the open direction via *Mixer Up*.

The closing of the outputs *Mixer Up* and *Mixer Down* arises from the difference between the target mixer position and the actual mixer position reported back via the analog input *Mixer Feedback*. Consequently, the binary mixer control can only work if the actual mixer position is reported back via the analog input *Mixer Feedback*.

Is the air/gas mixer to be controlled binarily, observe the notes in the section *Setting Position Control* on page 73.

## 7.9 Error Detection

The EmCon5 has various error detection functions, whose parameters can be configured specifically. If an error is detected, these errors are signaled on the device via special LEDs and special binary outputs, for example for a master control or display. The errors displayed can be reset by closing the binary input *Alarm Reset*.

### Mixer Position Control

The EmCon5 continually compares the mixer position targeted via the outputs with the mixer position reported back via the analog input *Mixer Feedback*. A maximum permissible difference can be set between the two by configuration. If this maximum permissible difference is exceeded for an adjustable period, the EmCon5 signals a control error of the mixer. To set the mixer position control, read the section *Setting Position Control* on page 73.

### Manifold Air Temperature Control

You define the maximum permissible manifold air temperature via the EmCon5 configuration. If it is exceeded for an adjustable period, the EmCon5 signals an exceedance of the maximum permissible manifold air temperature. To set the manifold air temperature control, read the section *Setting Manifold Air Temperature Control* on page 77.

### Manifold Pressure Control

The maximum permissible deviation of the actual manifold pressure from the target manifold pressure is set via the EmCon5 configuration. If it is exceeded for an adjustable period, the EmCon5 signals an exceedance of the maximum permissible manifold pressure. To set the manifold pressure control, read the section *Setting Manifold Pressure Control* on page 76.

### Error Detection at Sensor Inputs

If a deviation from the permissible signal range of 5 % or more is determined at the sensor inputs for a particular period, the EmCon5 signals a sensor error for the relevant input. More information on error detection at the sensor inputs is available in the section *Error Detection at Sensor Inputs* on page 62.

Information on error signaling is available in the section *Error Overview* on page 102.

# 8 SETTINGS VIA WINSCOPE

## 8.1 WinScope System requirements

The following minimum requirements must be met for the WinScope software:

- RS232 interface; alternatively USB 1.1 with a USB to RS232 converter
- Display with minimum VGA resolution (640 x 480 pixels) recommended
- Operating system: Microsoft® Windows® 98 / NT / 2000 / XP / Vista / 7 / 8
- RAM: Up to 1 GB may be necessary for runtime data recordings.

## 8.2 Executing WinScope

The WinScope software is on the storage device (USB flash drive or CD-ROM) enclosed with the EmCon5. You can execute WinScope directly from the storage device or from the computer. After the first start of WinScope, it is usually necessary to activate WinScope. To activate WinScope, read the section *Activating WinScope* on page 45.

### Executing from Storage Device

Proceed as follows:

- Via the menu:  
Start the file *Start.exe* on the storage device. Launch WinScope via *Software -> WinScope -> Run WinScope*.
- Directly from the storage device:  
Execute WinScope directly. It is on the storage device in the sub-directory *Installation* and is named as follows: *WinScope.exe*

### Executing from Computer

To execute WinScope from your computer, first copy WinScope from the storage device to your computer. Proceed as follows:

1. Select a location for saving WinScope on the hard disk of your computer, for example by creating a folder named *WinScope*.
2. Copy WinScope from the storage device to your computer:
  - Via the menu:  
Start the file *Start.exe* on the storage device. Copy WinScope via *Software -> WinScope -> Copy to computer* to your computer. Select in window *Copy files* the location selected in step 1.
  - Directly from the storage device:  
Copy from the directory *Installation* of the storage device the file *WinScope.exe* to the location selected in step 1.
3. Note the location where the WinScope software is saved on your computer. Put a link on the desktop if needed by *right-clicking mouse on WinScope.exe -> Send to -> Desktop*.
  - ▶ WinScope can now be launched on your computer by double-clicking the file *WinScope.exe* or its shortcut.

### 8.3 Activating WinScope

WinScope initially starts in demo mode, which offers you restricted functionality. This can be seen in WinScope in the title bar of the main view by the suffix *demo version*.

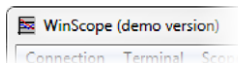

To permit WinScope to be used in full in combination with the EmCon5, activate WinScope.

Proceed as follows:

1. Launch WinScope by double-clicking the file *WinScope.exe*.
  - ▶ The main view of WinScope appears.
2. In the main window, go to *Help -> Activation Code* via the menu bar.
  - ▶ The window *WinScope - Activation* appears.

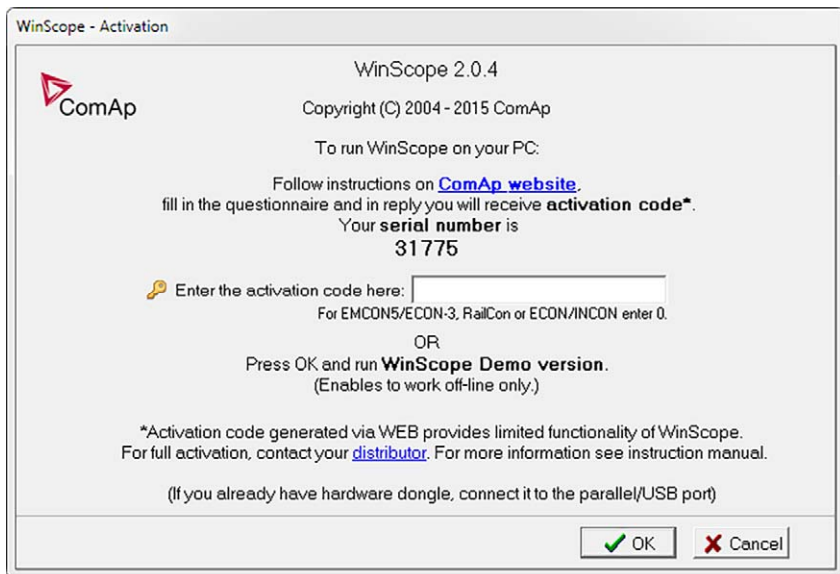

3. Enter on the right next to *Enter the activation code here* as code 0 and click the button *OK*.
  - ▶ All functions have now been activated in WinScope that are intended for use with the EmCon5. This activation is not lost after termination of the program on the computer.
  - ▶ The successful activation can be identified in the title bar of the main view of WinScope by the suffix *full version for EMCON5/INCON/ECON only*.

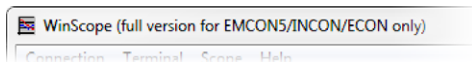

# 8 SETTINGS VIA WINSCOPE

## 8.4 Main View

The main view is divided into the following sections:

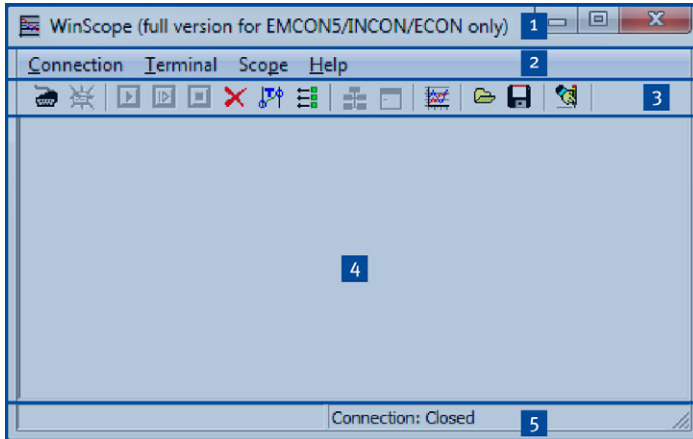

### Title Bar 1

Indicates the status of the activation of WinScope and the file names of loaded or saved runtime data recordings. In addition, shows the device designation and firmware version of the device when connected.

### Menu Bar 2, Toolbar 3

Various WinScope functions are opened via the entries in the menu bar and the icons of the toolbar. For more information read the section *Menu Bar and Toolbar* on page 48.

### Display Area 4

In this area, various windows are shown that are described starting from the section *Messages Window* on page 51. The size of each window is adjustable. Several windows can be shown at once.

### Status Bar 5

The status bar provides you with the following information (from left to right):

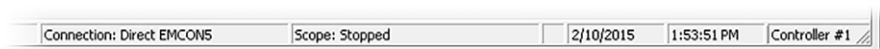

- **Connection**  
Indication of the connection status
- **Scope**  
Status of the runtime data recording

- Current date
- Current time
- **Controller**  
Number (*Controller #*) of the control unit with which WinScope is currently connected. The field remains empty if there is no connection to a control unit.

Please note that not all elements of the status bar are displayed if the window is narrow.



#### **WinScope runs as demo version**

If the information text *demo version* appears in the title line, WinScope has not been activated and particular functions are unavailable. To activate WinScope, read the section *Activating WinScope* on page 45.











#### **Window sizes and window positioning**

- In the case of the main window and the windows *Channels*, *Chart* and *Setpoints*, you can adjust the window height and window width individually. Bear in mind in this regard that you can also set the windows so that not all information and options are visible.
- The windows *Channels*, *Chart* and *Setpoints* appear in WinScope within the display area. The windows can only be displayed and placed within this display area. Bear in mind in this regard that the size of the main window can be set so that the windows *Channels*, *Chart* and *Setpoints* are invisible. In this case, draw the main window larger.
- All other windows (for example *Controllers*, *Options*) have a fixed size and can be placed outside the main window.







# 8 SETTINGS VIA WINSCOPE

## 8.4.1 Menu Bar and Toolbar

In the main view, the following functions are available to you via the icons on the toolbar and the entries in the menu bar:

Symbol	Menu	Short cut	Function
	<i>Connection -&gt; Open connection</i>		Opens the window <i>Open connection</i> via which a connection can be established between the computer and the EmCon5.
	<i>Connection -&gt; Close connection</i>		Terminates the connection between computer and EmCon5.
	<i>Connection -&gt; Load data from file</i>		Loads a runtime data recording including channel list that is available as <i>WinScope data file</i> (SDT, DAT or XML).
	<i>Connection -&gt; Save data to file</i>		Saves the current runtime data recording including channel list in a file as <i>WinScope data file</i> (SDT).
	or		
	<i>Connection -&gt; Save selected data to file</i>		Saves the runtime data range that was selected in the <i>Chart</i> window as <i>WinScope data file</i> (SDT).
	<i>Connection -&gt; Export</i>		Exports the entire runtime data recording as Excel® list (XLS) or CSV file.
	<i>Connection -&gt; Exit</i>		Terminates WinScope.
	<i>Terminal -&gt; Show</i>		Opens a terminal connection to the connected device. This function cannot be used in combination with the EmCon5.
	<i>Scope -&gt; Start scope</i>	<i>ALT+O</i>	Starts the runtime data recording in default mode. WinScope records the channels that are selected in the <i>Channels</i> window.
	<i>Scope -&gt; Start scope in automatic mode</i>	<i>ALT+A</i>	Starts the runtime data recording in automatic mode. WinScope only records in automatic mode if the values of at least one selected channel are within the range that is defined in the <i>Channels</i> window under <i>Auto start scope</i> . Only channels are recorded that are selected in the <i>Channels</i> window (see <i>Channels Window</i> on page 78)
	<i>Scope -&gt; Stop scope</i>	<i>Alt+S</i>	Terminates the runtime data recording.



Symbol	Menu	Short cut	Function
	Scope -> Clear data	Alt+D	Deletes all recorded data in the <i>Chart</i> window.
	Scope -> Channels		Opens the <i>Channels</i> window. On this, read chapter <i>Channels Window</i> on page 78.
	Scope -> Controllers		Opens the <i>Controllers</i> window, which supports multi-device administration. The <i>Controllers</i> window cannot be used in combination with the EmCon5.
	Scope -> Period		Opens the <i>Period</i> window. On this, read chapter <i>Period Window</i> on page 86.
	Scope -> Chart		Opens the <i>Chart</i> window. On this, read chapter <i>Chart Window</i> on page 88.
	Scope -> Setpoints		Opens the <i>Setpoints</i> window. On this, read chapter <i>Setpoints Window</i> on page 52.
	Scope -> Read Dongle	CTRL+U	Reads out the hardware dongle with which WinScope can alternatively be activated. Activation via a hardware dongle is no longer provided.
	Scope -> Options		Opens the <i>Options</i> window. On this, read chapter <i>Options Window</i> on page 96.
	Scope -> Select language		Opens the window <i>Select application language</i> , via which the interface language of WinScope can be changed. Currently no other interface languages are available for WinScope.
	Help -> About		Opens information about WinScope.
	Help -> Activation code		Opens the window <i>WinScope - Activation</i> via which WinScope can be activated. On this, read chapter <i>Activating WinScope</i> on page 45.

Functions related to the password protection of the device parameters are available via the icons in the toolbar and the entries in the menu bar when there is a connection established between the EmCon5 and your computer. For more information, read the section *Password Protection* on page 56.

# 8 SETTINGS VIA WINSCOPE

When the *Setpoints* window is open, the functions of the *Setpoints* window are additionally available in the menu bar of the main view. For more information on the functions of the *Setpoints* window, read the section *Setpoints Window* on page 52.

## 8.4.2 Establishing A Connection to the EmCon5

WinScope establishes a connection to the EmCon5 via the function *Open connection*. In the main view, you open the function via:



*Connection -> Open connection*

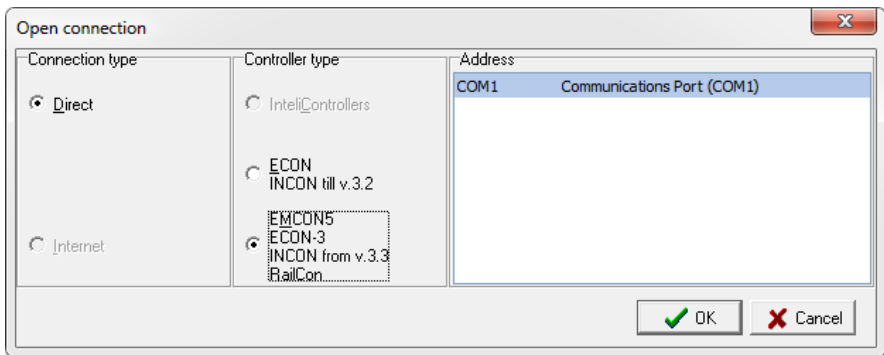

Proceed as follows:

1. Make sure that the EmCon5 is connected to your computer via its RS232 connection.
2. **Connection type**  
Make sure that *Direct* is selected.
3. **Controller type**  
Select *EMCON5 ECON-3 INCON from v.3.3 RailCon*.
4. **Address**  
Select the communication port (*COM*) via which your computer is connected to the EmCon5.
5. Confirm your selection using the button *OK*. WinScope closes the window *Open connection*.
  - ▶ The successful connection between the EmCon5 and WinScope is displayed in the main view in the status line by the text *Connection: Direct EMCON5*. In addition, WinScope displays the device name and firmware version of the device in the title bar.
  - ▶ In the event of an unsuccessful connection, an error message appears in the *Messages* window (see *Messages Window* on page 51).

## 8.5 Messages Window

WinScope records error messages regarding the connection to the EmCon5 via the *Messages* window. WinScope opens the window automatically as soon as an error message has to be recorded.

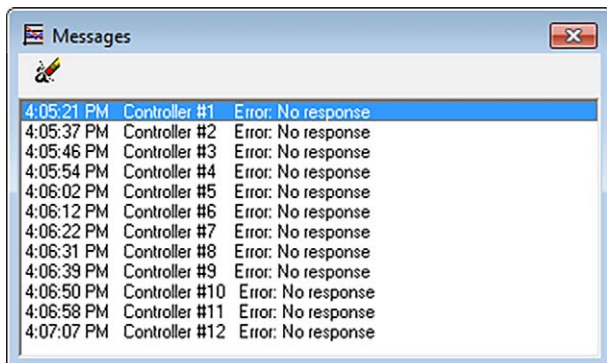

The following function is available to you via the toolbar:

Symbol	Designation	Function
	<i>Clear</i>	Deletes all recorded entries in the <i>Messages</i> window.

# 8 SETTINGS VIA WINSCOPE

## 8.6 Setpoints Window



### Risk of destruction!

Incorrect configuration of the EmCon5 may lead to serious damage to the engine. Consequently, the EmCon5 may only be configured by trained, authorized personnel. If you have any questions, contact your MOTORTECH contact partner (see *Customer Service Information* on page 107).

Damage caused by incorrect configuration is not covered by warranty.



### Cancel password protection before editing parameters

The parameters of the groups *Sensor Chars*, *Control* and *Protections* are protected by a password. They can only be edited after the password protection has been cancelled by entering the password. For more information, read the section *Password Protection* on page 56.

Configure the EmCon5 using the *Setpoints* window. From the main view, you open the window via:



*Scope -> Setpoints*

Groups	Name	Actual setting	Dimension	Alternative setting
Sensor Chars	MixerFeedblnp1	9	-	0
Control	MixerFeedblnp2	819	-	830
Protections	MixerFeedback1	0.0	%	0.1
CAN comm	MixerFeedback2	100.0	%	100.0
	EnginePwr-Inp1	165	-	165
	EnginePwr-Inp2	675	-	730
	EnginePower1	0.0	%	0.0
	EnginePower2	100.0	%	100.0
	MAP-Input1	160	-	200
	MAP-Input2	800	-	1000

Limit: 0 .. 1023

Read the section *Toolbar* on page 55 for an explanation of the icons in the toolbar of the *Setpoints* window.

The following information is provided:

- **Groups**  
The blue marking indicates which parameter group is currently selected and displayed in the configuration area. The parameter group is changed by clicking on the desired entry. You can find more information on the parameter groups in the following sections.
- **Name**  
Name of the parameter
- **Actual setting**  
Actual value of the parameter. The parameters are changed in this column.



#### **Actual setting column**

The EmCon5 implements parameter changes in the column *Actual setting* as follows:

- Parameter changes carried out manually are implemented by the EmCon5 immediately and permanently stored in the configuration.
- If you have loaded a configuration from a setpoints file in the column *Actual setting*, it is only implemented by the EmCon5 if you have downloaded the configuration via the function *Write all setpoints to controller* to the EmCon5.

- **Dimension**  
Unit of the parameter
- **Alternative setting**  
WinScope displays a loaded alternative configuration in the optional *Alternative setting* column. This allows the current configuration to be compared with a previously saved configuration before importing the saved configuration to the EmCon5. In addition, the *Import selected alternative setpoint* function can be used to only import selected parameters to the current configuration.

## 8 SETTINGS VIA WINSCOPE

WinScope compares the values of the column *Alternative setting* with the current configuration in the column *Actual setting* and displays the following information:

Display	Meaning
<b>Value bold</b>	The value in the column <i>Alternative setting</i> deviates from the value in the column <i>Actual setting</i> .
Cell background gray	The values in both columns agree.
Cell background yellow	The value in the column <i>Alternative setting</i> is outside the permissible range.
Value red	The value could not be downloaded to the EmCon5.









Status bar:

- **Limit**

WinScope shows the value range in which the currently selected parameter is permitted for editing.

### 8.6.1 Toolbar

The following functions are available in the *Setpoints* window via the icons in the toolbar. Alternatively, you can retrieve the functions via additional entries in the menu bar of the main view if the *Setpoints* window is active.



Symbol	Menu bar main view	Short cut	Function
	<i>Setpoints -&gt; Read all setpoints from controller</i>		Uploads the configuration of the EmCon5 to the computer and displays it in the column <i>Actual setting</i> .
	<i>Setpoints -&gt; Write all setpoints to controller</i>		Downloads the configuration from the column <i>Actual setting</i> to the EmCon5.
	<i>Setpoints -&gt; Open setpoints</i>		Opens an existing configuration previously saved as <i>Setpoints file</i> (EMS) and displays it in the column <i>Actual setting</i> .  At this step, the configuration has not yet been transferred to the configuration memory of the EmCon5.
	<i>Setpoints -&gt; Save setpoints</i>		Saves the current configuration in the column <i>Actual setting</i> in a file as <i>Setpoints file</i> (EMS).
	<i>Setpoints -&gt; Open alternative setpoints</i>		Opens an existing configuration previously saved as <i>Setpoints file</i> (EMS) and displays it as alternative configuration in the column <i>Alternative setting</i> .
	<i>Setpoints -&gt; Import alternative setpoints</i>	CTRL+I	The alternative configuration that is loaded in the column <i>Alternative setting</i> overwrites the current configuration in the column <i>Actual setting</i> and is downloaded to the EmCon5.
	<i>Setpoints -&gt; Import selected alternative setpoint</i>	CTRL+W	The parameter selected in the column <i>Alternative setting</i> is adopted in the column <i>Actual setting</i> into the current configuration and downloaded to the EmCon5.
	<i>Setpoints -&gt; Close alternative setpoints</i>		Closes the alternative configuration loaded in the column <i>Alternative setting</i> .
	<i>Export setpoints</i>		Exports the current configuration to the column <i>Actual setting</i> as text file.

## 8 SETTINGS VIA WINSCOPE

### 8.6.2 Password Protection

The parameters of the groups *Sensor Chars*, *Control* and *Protections* are protected by a password. In order to be able to edit the parameters, use the entry *Enter password* to enter the password with which the parameters are protected during an existing connection to the EmCon5. The password in the as-delivered state is the number 0. The parameters can be modified once the password has been entered. You can change the password via the entry *Change password*, once you have established a connection between the computer and the EmCon5. The password can consist of up to five numbers. You can withdraw the authorization via the *Deactivate password* field. Disconnecting from the EmCon5 also disables the authorization.

The following functions are available when the EmCon5 is connected in the main view via the icons in the toolbar and the entries in the menu bar:

Symbol	Menu bar main view	Function
	<i>Scope -&gt; Enter password</i>	Opens the <i>Password</i> window. The parameters can be modified via WinScope once the password has been entered.
	<i>Scope -&gt; Change password</i>	Opens the window <i>Change password</i> which can be used to change the existing password. The password of the EmCon5 in the as-delivered state is the number 0.
	<i>Scope -&gt; Deactivate password</i>	Withdraws the authorization to change parameters. The parameters of the relevant groups are protected thereafter.



## 8.7 Sensor Chars Group

The EmCon5 is adjusted to the signal and measured value range of the units connected to the sensor inputs via the *Sensor Chars* group and the characteristic configured for the methane content adjustment of the fixed mixer positions. Note that the parameters of this group are protected by a password. In order to be able to edit these parameters, remove the password protection by entering the password (see *Password Protection* on page 56). From the main view, you open the group via:

Scope -> Setpoints: Groups -> Sensor Chars

Groups	Name	Actual setting	Dimension
Sensor Chars	MixerFeedblnp1	9	-
Control	MixerFeedblnp2	819	-
Protections	MixerFeedback1	0.0	%
CAN comm	MixerFeedback2	100.0	%
	EnginePwr-Inp1	165	-
	EnginePwr-Inp2	675	-
	EnginePower1	0.0	%
	EnginePower2	100.0	%
	MAP-Input1	160	-
	MAP-Input2	820	-
	MAP1	0	mba
	MAP2	3000	mba
	MAT-Input1	382	-
	MAT-Input2	603	-
	MAT1	-20	°C
	MAT2	120	°C
	%CH4-Input1	0	-
	%CH4-Input2	330	-
	%CH4-1	40.0	%
	%CH4-2	60.0	%
	MxPos40%CH4	44.0	%
	MxPos60%CH4	36.0	%

Limit: 0 .. 1023

## 8 SETTINGS VIA WINSCOPE



### Configuring the sensor inputs

It is essential that the settings in the group *Sensor Chars* and the jumper settings on the EmCon5 board correspond with the characteristics of the units connected for proper functioning of the EmCon5. Before configuring the sensor inputs, read the section *Signal Processing at the Sensor Inputs* on page 58 on this, where you will obtain additional information.



### Unused sensor inputs

If a sensor input is not used, disable error detection on the relevant input to ensure the correct functioning of the EmCon5. More information on this is available in the section *Error Detection at Sensor Inputs* on page 62.

The following sections include information on configuring the parameters of the group *Sensor Chars*.

### 8.7.1 Signal Processing at the Sensor Inputs

The EmCon5 can process various input quantities at the analog sensor inputs and these can be adjusted to the various operating and value ranges of the connected units. All analog input signals undergo a linear conversion to digital values on a scale from 0 to 1023 in the EmCon5 for internal processing.

The following steps must be performed for every sensor input to ensure that the EmCon5 can correctly interpret and process the signals transmitted by the sensor inputs:

- Adjust input quantities
- Adjust operating range
- Adjust measured value output

#### Adjust Input Quantities

The input quantity at the sensor inputs may be a resistance, current or voltage signal. The maximum signal ranges that can be processed are prescribed by the EmCon5 and are identical for all sensor inputs with the exception of the input *Mixer Feedback*. Using the jumpers on the EmCon5 board, set for each sensor input the input quantity that matches the connected unit (see *Set Jumpers* on page 29).

Depending on the jumpers set, the EmCon5 can process the following signal ranges at the sensor inputs:

Input	Signal range at jumper position		
	R (resistance)	I (current)	U (voltage)
Mixer Feedback	0 – 2.5 kΩ	0 – 25 mA	0 – 12.5 V
Engine Power	0 – 250 Ω		0 – 1.25 V
MAP			
MAT			
%CH <sub>4</sub>			

### Internal Analog-Digital Conversion

For further internal processing, all input signals at the sensor inputs are converted by the EmCon5 as follows into digital values between 0 and 1023:

Digital value

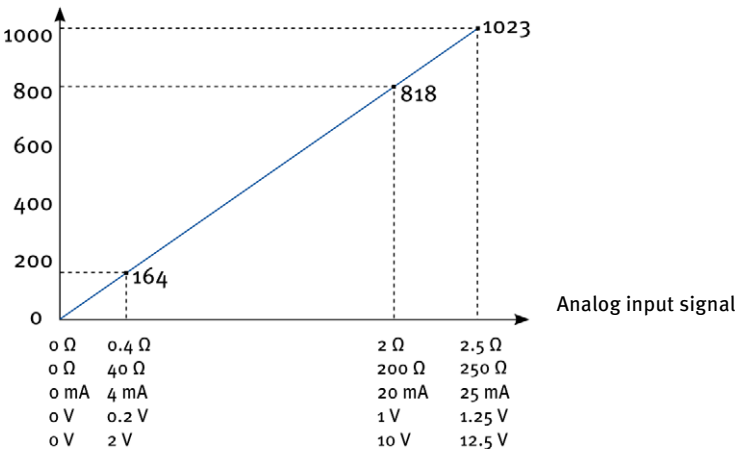

## 8 SETTINGS VIA WINSCOPE

These analog to digital converted values are in addition assigned to the following internal parameters:

Input	Internal parameters after analog-digital conversion
Mixer Feedback	Mixer-AD1Input
Engine Power	EngPwrAD2Input
MAP	MAP-AD3 Input
MAT	MAT-AD4 Input
%CH <sub>4</sub>	CH <sub>4</sub> -AD5 Input

These internal parameters can be read out and displayed via WinScope.

### Adjust Operating Range

Normally the operating range of the connected unit is smaller than the signal range that the EmCon5 can process at the relevant sensor input. Consequently, the EmCon5 must be adjusted to the operating range of the connected unit to function properly. For this purpose, specify for each input the beginning and end value of the operating range as converted digital value in WinScope (for example 164 for a 4 mA voltage signal and 818 for 20 mA).

### Adjust Measured Value Output

To enable the EmCon5 to output and display the input signals correctly as measured values, state in WinScope for each digital beginning and end value of the operating range which measured value it correlates with (for example for the input *MAP* 0 mbar for 4 mA, 3000 mbar for 20 mA). The EmCon5 calculates the values in-between linearly. For this purpose, take notice of the following configuration example for the analog input *MAP*.



### Configuration example for the analog input MAP

A manifold pressure sensor with an operating range from 0 mbar to 3,000 mbar outputs its measured values as a current signal in a signal range from 4 mA to 20 mA. A signal of 4 mA corresponds to a manifold pressure of 0 mbar, a signal of 20 mA corresponds to a manifold pressure of 3,000 mbar.

On the EmCon5 board, set the jumper at the sensor input *MAP* on I to enable the EmCon5 to evaluate the current signal present at this input. After the analog-digital conversion, 4 mA at the analog input *MAP* correspond to the digital value 164, 20 mA correspond to the digital value 818.

Parameters are configured as follows via WinScope:

<i>MAP-Input1</i>	164	Starting value for the operating range after the analog-digital conversion
<i>MAP-Input2</i>	818	End value for the operating range after the analog-digital conversion
<i>MAP1</i>	0 mbar	Measured manifold pressure value that corresponds to the starting value of the operating range.
<i>MAP2</i>	3000 mbar	Measured manifold pressure value that corresponds to the end value of the operating range.

# 8 SETTINGS VIA WINSCOPE

## 8.7.2 Error Detection at Sensor Inputs

### Maximum Tolerated Signal Deviation

If the input signal deviates by more than 5 percentage points or more from the operating range of the unit connected at the sensor inputs, the EmCon5 signals a sensor error for the relevant input (*Sensor Error*). See also the following example:



### Example: Error detection at sensor inputs

The connected unit has an operating range from 4 mA to 20 mA, i. e. values between 164 and 818 are permissible at the sensor input after the analog-digital conversion.

Digital value

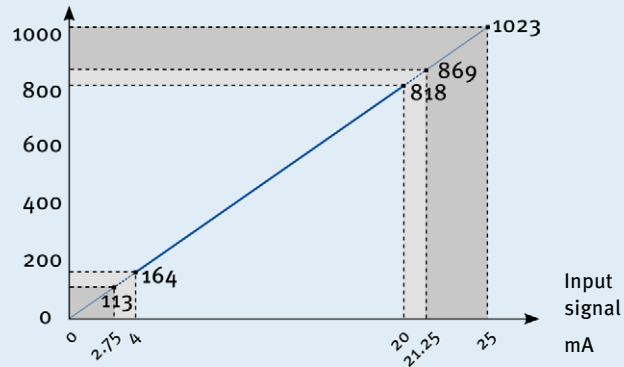

If there is an input signal of  $\leq 2.75$  mA or  $\geq 21.25$  mA, it deviates at least 5 percentage points from the operating range. If this deviation exists for a particular period, the EmCon5 signals a sensor error.

Bear in mind that in the following cases the EmCon5 cannot signal any sensor error:

- The configured *Input1* value (e.g. *MAP-Input1*) is below 51 and is not met at the corresponding sensor input.
- The configured *Input2* value (e.g. *MAP-Input2*) is above 972 and is exceeded at the corresponding sensor input.

For more information on the signaling of errors, read the section *Error Overview* on page 102.

### Maximum Duration of the Deviation

The maximum tolerated duration of the signal deviation from the operating range depends on the input:

- *Mixer Feedback, Engine Power, MAT, %CH4*: The signal deviation must exist for at least 1 second for the EmCon5 to signal a sensor error.
- *MAP*: You can define the maximum tolerated duration of the signal deviation in WinScope using the *MAP Fls del* parameter. To configure this parameter, read section *Setting Control of MAP Input* on page 76.

### Disabling Error Detection on the Sensor Input

To deactivate the error detection at the individual sensor inputs, for example because no unit is connected to this input, set the relevant *Input1* value (e. g. *%CH4-Input1*) to 0 and the relevant *Input2* value (e. g. *%CH4-Input2*) to 1023.

## 8.7.3 Configuring Mixer Feedback Input

You configure the sensor input *Mixer Feedback* in the group *Sensor Chars* via the following parameters:

MixerFeedbInp1	9	-
MixerFeedbInp2	819	-
MixerFeedback1	0.0	%
MixerFeedback2	100.0	%

You can make the following settings:

- **MixerFeedbInp1**  
Starting value for the operating range after the analog-digital conversion on the input *Mixer Feedback*
- **MixerFeedbInp2**  
End value for the operating range after the analog-digital conversion on the input *Mixer Feedback*
- **MixerFeedback1**  
Position of the mixer in percent corresponding to the starting value *MixerFeedbInp1* (generally 0 %).
- **MixerFeedback2**  
Position of the mixer in percent corresponding to the end value *MixerFeedbInp2* (generally 100%).

## 8 SETTINGS VIA WINSCOPE

### 8.7.4 Configuring Engine Power Input

You configure the sensor input *Engine Power* in the group *Sensor Chars* via the following parameters:

EnginePwr-Inp1	165	-
EnginePwr-Inp2	675	-
EnginePower1	0.0	%
EnginePower2	100.0	%

You can make the following settings:

- **EnginePwr-Inp1**  
Starting value for the operating range after the analog-digital conversion on the input *Engine Power*
- **EnginePwr-Inp2**  
End value for the operating range after the analog-digital conversion on the input *Engine Power*
- **EnginePower1**  
Engine power in percent corresponding to the starting value *EnginePwr-Inp1* (generally 0 %).
- **EnginePower2**  
Engine power in percent corresponding to the end value *EnginePwr-Inp2* (generally 100 %).

### 8.7.5 Configuring MAP Input

You configure the sensor input *MAP* in the group *Sensor Chars* via the following parameters:

MAP-Input1	160	-
MAP-Input2	820	-
MAP1	0	mba
MAP2	3000	mba

You can make the following settings:

- **MAP-Input1**  
Starting value for the operating range after the analog-digital conversion on the input *MAP*
- **MAP-Input2**  
End value for the operating range after the analog-digital conversion on the input *MAP*
- **MAP1**  
Manifold pressure corresponding to the starting value *MAP-Input1*
- **MAP2**  
Manifold pressure corresponding to the end value *MAP-Input2*



### 8.7.6 Configuring MAT Input

You configure the sensor input *MAT* in the group *Sensor Chars* via the following parameters:

MAT-Input1	382	-
MAT-Input2	603	-
MAT1	-20	°C
MAT2	120	°C

You can make the following settings:

- **MAT-Input1**  
Starting value for the operating range after the analog-digital conversion on the input *MAT*
- **MAT-Input2**  
End value for the operating range after the analog-digital conversion on the input *MAT*
- **MAT1**  
Manifold air temperature corresponding to the starting value *MAT-Input1*
- **MAT2**  
Manifold air temperature corresponding to the end value *MAT-Input2*

### 8.7.7 Configuring %CH<sub>4</sub> Input

You configure the sensor input *%CH<sub>4</sub>* in the group *Sensor Chars* via the following parameters:

%CH <sub>4</sub> -Input1	0	-
%CH <sub>4</sub> -Input2	330	-
%CH <sub>4</sub> -1	40.0	%
%CH <sub>4</sub> -2	60.0	%

You can make the following settings:

- **%CH<sub>4</sub>-Input1**  
Starting value for the operating range after the analog-digital conversion on the input *%CH<sub>4</sub>*
- **%CH<sub>4</sub>-Input2**  
End value for the operating range after the analog-digital conversion on the input *%CH<sub>4</sub>*
- **%CH<sub>4</sub>-1**  
Methane content in percent corresponding to the starting value *%CH<sub>4</sub>-Input1*
- **%CH<sub>4</sub>-2**  
Methane content in percent corresponding to the end value *%CH<sub>4</sub>-Input2*

## 8 SETTINGS VIA WINSCOPE

### 8.7.8 Setting the Characteristic for the Methane Content Adjustment

The characteristic for the methane content adjustment of the fixed mixer positions is configured in the group *Sensor Chars* via the following parameters:

MxPos40%CH4	44.0	%
MxPos60%CH4	36.0	%

You can make the following settings:

- [MxPos40%CH4](#)  
Mixer position in percent that is to be targeted at a methane content of 40 %.
- [MxPos60%CH4](#)  
Mixer position in percent that is to be targeted at a methane content of 60 %.

For more information on the adjustment of the fixed mixer positions to the methane content read the section *Methane Content Adjustment of the Fixed Mixer Positions* on page 40.

## 8.8 Control Group

The *Control* group is used to configure the mixture control of the EmCon5. Note that the parameters of this group are protected by a password. In order to be able to edit these parameters, remove the password protection by entering the password (see *Password Protection* on page 56). From the main view, you open the group via:

*Scope -> Setpoints: Groups -> Control*

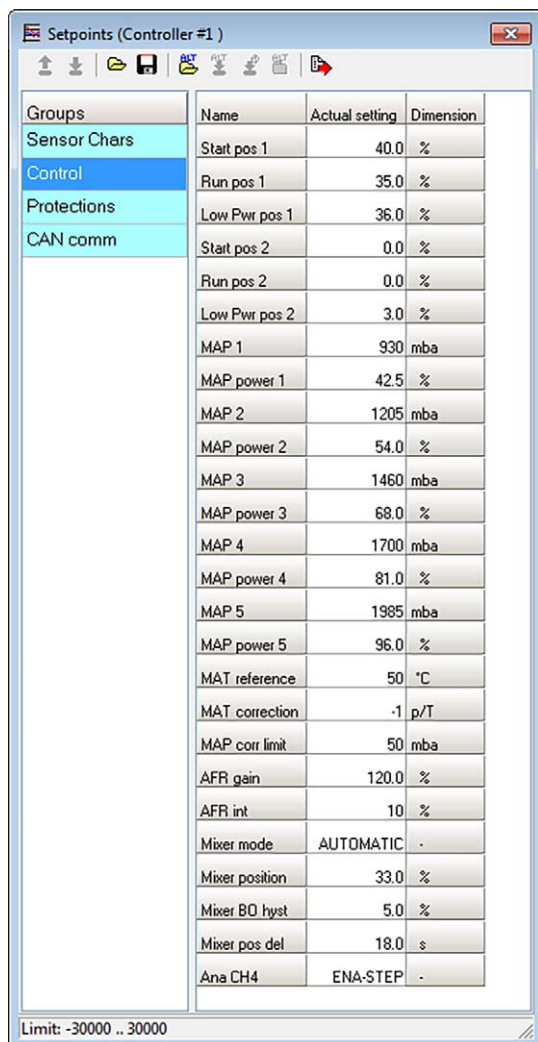

Groups	Name	Actual setting	Dimension
Sensor Chars	Start pos 1	40.0	%
<b>Control</b>	Run pos 1	35.0	%
Protections	Low Pwr pos 1	36.0	%
CAN comm	Start pos 2	0.0	%
	Run pos 2	0.0	%
	Low Pwr pos 2	3.0	%
	MAP 1	930	mba
	MAP power 1	42.5	%
	MAP 2	1205	mba
	MAP power 2	54.0	%
	MAP 3	1460	mba
	MAP power 3	68.0	%
	MAP 4	1700	mba
	MAP power 4	81.0	%
	MAP 5	1985	mba
	MAP power 5	96.0	%
	MAT reference	50	°C
	MAT correction	-1	p/T
	MAP corr limit	50	mba
	AFR gain	120.0	%
	AFR int	10	%
	Mixer mode	AUTOMATIC	-
	Mixer position	33.0	%
	Mixer BO hyst	5.0	%
	Mixer pos del	18.0	s
	Ana CH4	ENA-STEP	-

Limit: -30000 .. 30000

## 8 SETTINGS VIA WINSCOPE

The following sections include information on configuring the parameters of this group.

### 8.8.1 Setting Fixed Mixer Positions

The fixed mixer positions are set in the group *Control* via the following parameters:

Start pos 1	40.0	%
Run pos 1	35.0	%
Low Pwr pos 1	36.0	%
Start pos 2	0.0	%
Run pos 2	0.0	%
Low Pwr pos 2	3.0	%

You can make the following settings:

- **Start pos 1**  
Start position in percent for the first mixer position set
- **Run pos 1**  
Run position in percent for the first position set
- **Low Pwr pos 1**  
Low power position in percent for the first mixer position set
- **Start pos 2**  
Start position in percent for the second mixer position set
- **Run pos 2**  
Run position in percent for the second mixer position set
- **Low Pwr pos 2**  
Low power position in percent for the second mixer position set

More information on the mixer position sets can be found in the section *Configurable Fixed Mixer Position Sets* on page 39.

## 8.8.2 Configuring Manifold Pressure Characteristic

The manifold pressure characteristic is configured in the group *Control* via the following parameters:

MAP 1	930	mba
MAP power 1	42.5	%
MAP 2	1205	mba
MAP power 2	54.0	%
MAP 3	1460	mba
MAP power 3	68.0	%
MAP 4	1700	mba
MAP power 4	81.0	%
MAP 5	1985	mba
MAP power 5	96.0	%
MAT reference	50	°C
MAT correction	-1	p/T
MAP corr limit	50	mba

You can make the following settings:

- **MAP 1**  
Manifold pressure target value of the first point of the characteristic in millibar for the engine power defined in the parameter *MAP power 1*
- **MAP power 1**  
Engine power of the first point of the characteristic in percent that must be produced at the manifold pressure target value *MAP 1*. Simultaneously, the control range of the power-dependent air/fuel mixture control begins with this parameter.
- **MAP 2**  
Manifold pressure target value of the second point of the characteristic in millibar for the engine power defined in the parameter *MAP power 2*
- **MAP power 2**  
Engine power of the second point of the characteristic in percent that must be produced at the manifold pressure target value *MAP 2*.
- **MAP 3**  
Manifold pressure target value of the third point of the characteristic in millibar for the engine power defined in the parameter *MAP power 3*
- **MAP power 3**  
Engine power of the third point of the characteristic in percent that must be produced at the manifold pressure target value *MAP 3*.

## 8 SETTINGS VIA WINSCOPE

- **MAP 4**  
Manifold pressure target value of the fourth point of the characteristic in millibar for the engine power defined in the parameter *MAP power 4*
- **MAP power 4**  
Engine power of the fourth point of the characteristic in percent that must be produced at the manifold pressure target value *MAP 4*.
- **MAP 5**  
Manifold pressure target value of the fifth point of the characteristic in millibar for the engine power defined in the parameter *MAP power 5*
- **MAP power 5**  
Engine power of the fifth point of the characteristic in percent that must be produced at the manifold pressure target value *MAP 5*.
- **MAT reference**  
Reference temperature of the manifold pressure characteristic in °C
- **MAT correction**  
Correction factor for the manifold pressure target value in the event of deviations from the reference temperature. The entry refers to a deviation of 10 °C. At temperatures in the manifold above the reference temperature, *MAT correction* is added proportionally to the manifold pressure target value, in the case of temperatures in the manifold below the reference temperature, *MAT correction* is subtracted proportionally to the manifold pressure target value.
- **MAP corr limit**  
Maximum value by which the manifold pressure target value can be positively and negatively corrected in the event of deviations from the reference temperature.



### Configuration of the manifold pressure characteristic

Observe the following conditions when configuring the manifold pressure characteristic of the EmCon5:

- The manifold pressure characteristic must consist of at least two setpoints, i. e. at least *MAP 1*, *MAP power 1*, *MAP 2* and *MAP power 2* must be defined.
- The manifold pressure characteristic must cover the range from the first setpoint through to full load (=100 %).
- The values for *MAP x* and *MAP power x* must rise from one setpoint to the next.
- The characteristic must always begin with *MAP 1* and *MAP power 1*.
- For setpoints you do not use, assign the corresponding parameters *MAP x* and *MAP power x* the value 0. You may not leave out any setpoints.

### Example

You would like to define a manifold pressure characteristic with three setpoints.

*Solution:*

1. Define in ascending order the parameters *MAP 1* to *3* and *MAP power 1* to *3*.
2. Set the parameters *MAP 4* and *5* and *MAP power 4* and *5* to 0.

There is more information on the manifold pressure characteristic in the section *Power-Dependent Air/Fuel Mixture Control* on page 38.

## 8 SETTINGS VIA WINSCOPE

### 8.8.3 Setting Control Parameters of the Power-Dependent Mixture Control

The control parameters of the power-dependent air/fuel mixture control are configured in the group *Control* via the following parameters:

AFR gain	120.0	%
AFR int	10	%

The power-dependent air/fuel mixture control of the EmCon5 is designed as a constant proportional-integral (PI) controller. The parameter *AFR gain* defines the proportional share (P share) of the PI control, the integral share (I share) via the parameter *AFR int*. The control speed is calculated according to the following formula:

$$\%/min = - \{ \text{sign}(\text{AFR gain}) \} (\text{AFR int} * \Delta) / 500$$

$\Delta$  = Difference between the manifold pressure target value calculated and the actual manifold pressure measured

You can make the following settings:

- **AFR gain**  
Proportional share of the PI control of the power-dependent air/fuel mixture control in percent
- **AFR int**  
Integral share of the PI control of the power-dependent air/fuel mixture control in percent

### 8.8.4 Setting Mixture Control Mode

You configure the mixture control mode in the group *Control* via the following parameters:

Mixer mode	AUTOMATIC	-
------------	-----------	---

#### Mixer mode

Setting the desired mixture control mode. The following modes are available:

- **MANUAL:** The current mixer position is set via the parameter *Mixer position* (see section *Setting Manual Mixer Position* on page 73).
- **AUTOMATIC:** The EmCon5 drives to the fixed mixer positions according to the signals at the inputs *Gas Selection*, *Engine Run* and *GCB Closed*. When the generator is running synchronously with the mains (input *GCB Closed* closed), the power-dependent air/fuel mixture control is activated as soon as the engine power reaches the power-dependent control range.
- **AUT-PAR:** The mode *AUT-PAR* corresponds to the mixture control mode *AUTOMATIC*, but the power-dependent air/fuel mixture control is only activated if the gen-set is running parallel to the mains (input *MCB closed* closed) and the engine power is in the power-dependent control range.



There is more information on mixture control modes in the section *Mixture Control Modes* on page 37.

### 8.8.5 Setting Manual Mixer Position

You configure the position of the mixer in mixture control mode *MANUAL* in the group *Control* via the following parameter:

Mixer position	33.0	%
----------------	------	---

#### Mixer position

Position of the mixer in percent that should be taken by the mixer in the mixture control mode *MANUAL*.



#### Mixer control in the *MANUAL* mixture control mode

The mixer position entered in WinScope for the *Mixer position* parameter is immediately implemented by the EmCon5 in the *MANUAL* mixture control mode, but only permanently stored in the device once you download the configuration to the EmCon5.

### 8.8.6 Setting Position Control

You configure the position control in the group *Control* via the following parameters:

Mixer BO hyst	5.0	%
Mixer_pos del	18.0	s

The position control needs feedback on the current mixer position via the analog input *Mixer Feedback*. If there is no feedback signal at this input or if the signal is not to be evaluated, switch off the position control by setting the parameter *Mixer BO hyst* to 100 %.

The EmCon5 continually compares the mixer position targeted via the outputs with the mixer position reported back via the analog input *Mixer Feedback*. If the maximum difference between the two positions defined in the parameter *Mixer BO hyst* is exceeded for the period defined in the parameter *Mixer\_pos del*, the EmCon5 signals a control error of the mixer (see *Error Overview* on page 102).

You can make the following settings:

- **Mixer BO hyst**  
Maximum difference of the mixer's opening angle in percent, which may exist between the targeted mixer position and the position reported back via the input *Mixer Feedback*. Enter 100 % if you do not wish to use the position control.

# 8 SETTINGS VIA WINSCOPE

- **Mixer pos del**  
Period for which *Mixer BO hyst* must be exceeded until the EmCon5 signals an error in the mixer control via the LED *Mixer Warning*.



## Configuration of position control

### In case of analog mixer control

In case of analog mixer control via the output *Mixer Output*, the position control only serves to identify errors in the connected mixer control.

Therefore, you define the control deviation of the air/gas mixer via the parameter *Mixer BO hyst*. Via the parameter *Mixer pos del*, you take into account a delayed response of the connected mixer control.

### In case of binary mixer control

In case of binary mixer control via the outputs *Mixer Up* and *Mixer Down*, the position control is also used to check whether the mixer has reached the position targeted for by the EmCon5.

The *Mixer BO hyst* is used to define the control accuracy. The *Mixer pos del* parameter indicates the maximum duration required for the connected mixer control to reach the mixer position targeted by the EmCon5 (normally from the closed position to the open position and vice-versa). This way you prevent the EmCon5 from signaling a control error although the connected mixer control is working properly.

## 8.8.7 Setting the Methane Content Adjustment Mode

You configure the adjustment of the fixed mixer positions to the methane content in the group *Control* via the following parameter:

Ana CH4	ENA-STEP	.
---------	----------	---

### Ana CH<sub>4</sub>

The following control modes are available:

- **DISABLED:** The adjustment of the fixed mixer positions to the methane content is switched off. The EmCon5 drives to the fixed mixer positions according to the configuration.
- **ENA-FIX:** The EmCon5 determines the start position and run position using the characteristic line for methane content adjustment. The configured positions for engine start (*Start pos 1*, *Start pos 2*) and run position (*Run pos 1*, *Run pos 2*) are not taken into account. The EmCon5 drives to the low power position as defined in the configuration.

- **ENA-STEP:** The EmCon5 determines the fixed mixer positions via the characteristic line for methane content adjustment. The EmCon5 shifts the run position and the low power position based on the configured difference to the fixed start position.

The characteristic line for methane content adjustment is set in the group *Sensor Chars*. On this, read the section *Setting the Characteristic for the Methane Content Adjustment* on page 66.

For more information on the methane content adjustment of the fixed mixer positions read the section *Methane Content Adjustment of the Fixed Mixer Positions* on page 40.

## 8.9 Protections Group

You configure the error detection of the EmCon5 via the group *Protections*. Note that the parameters of this group are protected by a password. In order to be able to edit these parameters, remove the password protection by entering the password (see *Password Protection* on page 56). From the main view, you open the group via:

Scope -> Setpoints: Groups -> Protections

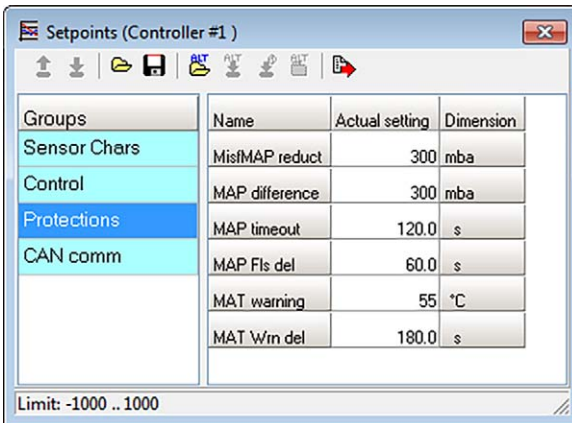

Groups	Name	Actual setting	Dimension
Sensor Chars	MisMAP reduct	300	mba
Control	MAP difference	300	mba
<b>Protections</b>	MAP timeout	120.0	s
CAN comm	MAP Fls del	60.0	s
	MAT warning	55	°C
	MAT W/m del	180.0	s

Limit: -1000 .. 1000

The following sections include information on configuring the parameters of this group.

## 8 SETTINGS VIA WINSCOPE

### 8.9.1 Setting Misfire Correction

You configure the correction of the manifold pressure target value in the group *Protections* via the following parameter:

MisfMAP reduct	300	mba
----------------	-----	-----

#### MisfMAP reduct

Correction value by which the calculated manifold pressure target value is corrected at closed input *Misfiring*. The correction value can be positive or negative and is added to the manifold pressure target value.

### 8.9.2 Setting Manifold Pressure Control

You configure the manifold pressure control in the group *Protections* via the following parameters:

MAP difference	300	mba
MAP timeout	120.0	s

If the maximum permissible manifold pressure deviation *MAP difference* is exceeded in the manifold for the period defined in the parameter *MAP timeout*, the EmCon5 signals a manifold pressure control error (see *Error Overview* on page 102).

You can make the following settings:

- **MAP difference**  
Maximum value by which the actual manifold pressure may deviate from the calculated manifold pressure target value positively or negatively.
- **MAP timeout**  
Maximum period that the maximum deviation from manifold pressure target value (*MAP difference*) may be exceeded.

### 8.9.3 Setting Control of MAP Input

You configure the control of the sensor input *MAP* in the group *Protections* via the following parameter:

MAP Fls del	60.0	s
-------------	------	---

#### MAP Fls del

Maximum period that the operating range at the input *MAP* can be exceeded or not met by 5 percentage points. If this period is overrun, the EmCon5 reports a sensor error (see *Error Overview* on page 102). The operating range is defined in the group *Sensor Chars* via the parameters *MAP-Input1* and *MAP-Input2* (see *Configuring MAP Input* on page 64).

More information on the mode of operation of the sensor input control is available in the section *Error Detection at Sensor Inputs* on page 62.

### 8.9.4 Setting Manifold Air Temperature Control

You configure the manifold air temperature control in the group *Protections* via the following parameters:

MAT warning	55	°C
MAT Wrn del	180.0	s

If the maximum permissible manifold air temperature *MAT warning* is exceeded for the period defined in the parameter *MAT Wrn del*, the EmCon5 signals an exceedance of the maximum permissible manifold air temperature (see *Error Overview* on page 102).

You can make the following settings:

- **MAT warning**  
Maximum permissible manifold air temperature that may not be exceeded in the manifold.
- **MAT Wrn del**  
Maximum permissible period that the maximum permissible manifold air temperature (*MAT warning*) may be exceeded in the manifold.

### 8.10 CAN Comm Group

The *CAN comm* group is used to configure the CAN bus interface of the EmCon5. From the main view, you open the group via:

*Scope -> Setpoints: Groups -> CAN comm*

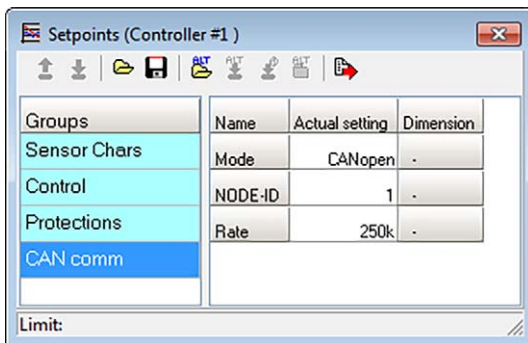

You can make the following settings:

- **Mode**  
Protocol that is to be used for communicating via the CAN bus interface. You can choose between the following protocols:

# 8 SETTINGS VIA WINSCOPE

- **CANopen**  
Protocol for communicating with devices that support the CANopen® protocol.
- **ComAp**  
Sets the ComAp communication protocol. The ComAp communication protocol is currently not supported.
- **NODE-ID**  
The EmCon5 node address for CAN bus interface communication. Note that IDs cannot be assigned more than once.
- **Rate**  
Data rate in baud for communicating via the CAN bus interface

## 8.11 Channels Window

The *Channels* window is used to configure the channels that are scanned during the runtime data recording and displayed in the *Chart* window. Communication objects (*ComObj*) are used to assign a parameter of the EmCon5 to each channel. You can set up as many as 32 channels. From the main view, you open the window via:

 *Scope -> Channels*

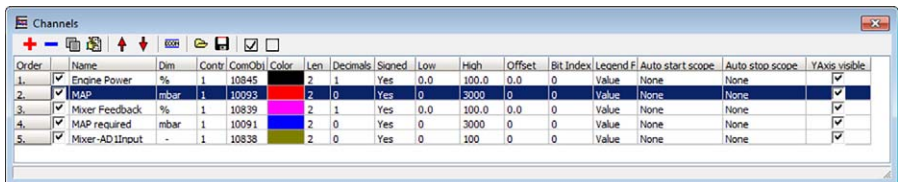

Order	Name	Dim	Contr	ComObj	Color	Len	Decimals	Signed	Low	High	Offset	Bit Index	Legend F	Auto start scope	Auto stop scope	Y Axis visible
1.	<input checked="" type="checkbox"/> Engine Power	%	1	10845	Black	2	1	Yes	0.0	100.0	0.0	0	Value	None	None	<input checked="" type="checkbox"/>
2.	<input checked="" type="checkbox"/> MAP	mbar	1	10693	Red	2	0	Yes	0	3000	0	0	Value	None	None	<input checked="" type="checkbox"/>
3.	<input checked="" type="checkbox"/> Mixer Feedback	%	1	10839	Blue	2	1	Yes	0.0	100.0	0.0	0	Value	None	None	<input checked="" type="checkbox"/>
4.	<input checked="" type="checkbox"/> MAP required	mbar	1	10691	Green	2	0	Yes	0	3000	0	0	Value	None	None	<input checked="" type="checkbox"/>
5.	<input checked="" type="checkbox"/> Mixer-AD11Input	-	1	10838	Yellow	2	0	Yes	0	100	0	0	Value	None	None	<input checked="" type="checkbox"/>

Read the section *Toolbar* on page 80 for an explanation of the icons in the toolbar of the *Channels* window.

For more information on the *Chart* window, read the section *Chart Window* on page 88.

The following information is provided:

- **Order**  
Display order of the channels in the legend of the runtime window *Chart*
- **Checkbox**  
The checkbox on the right next to the column indicates whether the channel is activated or deactivated.
  - If the checkbox is selected, the channel is activated. WinScope displays the channel in the runtime window *Chart* and scans it during runtime data recording.
  - If the checkbox has not been selected, the channel is deactivated. WinScope does not display the channel in the runtime window *Chart* and does not scan it either during runtime data recording.

- **Name**  
Display name of the channel
- **Dim**  
Unit (e. g. °C, mbar, %), with which the values of the channel are displayed.
- **Controller**  
Controller number of the device from which values are read out for this channel.
- **ComObj**  
Number of the communication object corresponding to a parameter of the EmCon5 to be read out and whose values WinScope is to read out via this channel.
- **Color**  
Display color of the channel in the *Chart* window
- **Len**  
Number of bytes of which a data element of the selected communication object consists.
- **Decimals**  
Number of decimal places that the output values of the selected communication object have.
- **Signed**  
Displays whether the data elements of the communication object are signed or unsigned. The following options are available:
  - **Yes**  
The data elements of the communication object are signed, i. e. they can have positive and negative values.
  - **No**  
The data elements of the communication object are unsigned, i. e. they have exclusively positive values.
- **Low**  
Output value of the selected communication object corresponding to the value 0 on the y-axis of the runtime diagram in the *Chart* window.
- **High**  
Output value of the selected communication object corresponding to the value 100 on the y-axis of the runtime diagram in the *Chart* window.
- **Offset**  
Offset of the output values of the selected communication object by which WinScope shifts the values for display in the runtime diagram of the *Chart* window.
- **Bit Index**  
Bit, which is selected for display in the legend.
- **Legend Format**  
Display format of the output value in the legend of the *Chart* window. The following formats are available:
  - **Value**  
Display of the output value as decimal number

# 8 SETTINGS VIA WINSCOPE



- **Binary**  
Display of the output value as binary number
- **StringList**  
Display of the output value as so-called string list
- **Auto start scope**  
Value range upon reaching WinScope begins runtime data recording in automatic mode.
- **Auto stop scope**  
Value range upon reaching WinScope ends runtime data recording in automatic mode.
- **YAxis visible**  
If the specific value scales are displayed on the y-axis in the *Chart* window via the function *Individual channel axes on/off* for each channel, the display of the corresponding value scales can be activated and deactivated for each channel.

The following settings can be made:









- **Select/deselect channel**  
To select a channel for display in the runtime window *Chart* and for runtime data recording, activate the checkbox of the corresponding channel.

## 8.11.1 Toolbar

The following functions are available in the *Channels* window via the icons in the toolbar. WinScope shows the designation of the function as soon as you hold the mouse above the corresponding symbol.

Symbol	Designation	Short cut	Function
	<i>Add channel</i>		Opens the window <i>Add channel</i> via which you can add more channels to the channel list. There is more information in the section <i>Adding Channels</i> on page 82.
	<i>Remove selected channel</i>		<p>Removes the channel from the channel list that you have selected with the mouse. Thus, the channel can no longer be selected for display in the <i>Chart</i> window.</p> <p>If you only want to deactivate the display in the <i>Chart</i> window and the recording of the channel, disable the checkbox in the line of the channel.</p>
	<i>Duplicate channels</i>		Creates a copy of the channels you have selected with the mouse. After clicking the button, the window <i>Select controller</i> appears. In this window, set 1 for the EmCon5 under <i>Controller</i> .



Symbol	Designation	Short cut	Function
	<i>Edit selected channel</i>	Alt+Enter	<p>Opens the window <i>Edit channel</i>, which can be used to edit the channel that you have selected with the mouse.</p> <p>Alternatively, the window <i>Edit channel</i> can be opened by double-clicking the desired channel with the left mouse button.</p> <p>The section <i>Editing Channels</i> on page 85 has more information on the window <i>Edit channel</i>.</p>
	<i>Move selected channel up</i>		Moves the channel selected with the mouse one line upwards. The order ( <i>Order</i> ) defined in the <i>Channels</i> window corresponds to the order in which WinScope displays the channels in the legend of the <i>Chart</i> window.
	<i>Move selected channel down</i>		Moves the channel selected with the mouse one line downwards. The order ( <i>Order</i> ) defined in the <i>Channels</i> window corresponds to the order in which WinScope displays the channels in the legend of the <i>Chart</i> window.
	<i>Set channels to ECON/INCON defaults</i>		Cannot be used in combination with the EmCon5.
	<i>Load channels from file</i>		Loads a channel list previously saved in a file as <i>WinScope channels file</i> (SHN).
	<i>Save channels to file</i>		Saves the current channel list in a file as <i>WinScope channels file</i> (SHN).
	<i>Enable selected channels</i>		Activates the channels selected with the mouse.
	<i>Disable selected channels</i>		Deactivates the channels selected with the mouse.

## 8 SETTINGS VIA WINSCOPE

### 8.11.2 Adding Channels

You can add channels shown in the *Chart* window via the window *Add channel*.



To open the window *Add channel*, click the left symbol in the *Channels* window.

**Add channel**

**Controlled variable**

Controller: Com. object:  
1 0 ...

Data len: Decimals: Format:  
1 0 Value

Name: Name: CH6  
Dim: Dim:

Signed  
 Bit index enabled

Bit index: -1

**Curve**

High (Y-Axis = 100)  
100

Offset:  
0

Low (Y-Axis = 0)  
0

Color:  
[Green] ...

**Limits**

Auto start scope: Auto stop scope:

Cross: Limit: Cross: Limit:  
None 0 None 0

Show limit in chart  Show limit in chart

OK Cancel

Make the following settings to add a channel:



#### Using the *Select com. object* window

Always select the desired display parameters via the window *Select com. object* for fast configuration. WinScope automatically sets all the relevant values when using this window.

## Controlled variable

- **Controller**  
Make sure that 1 is selected as controller number for the EmCon5.
- **Com. object**  
Using the number of the communication object (*Com. object*), select the parameter that is to be displayed via this channel in the *Chart* window.
  - ▶ For easy selection of the communication object, use the button . By clicking this button, the window *Select com. object* opens. In this window, you can select the desired communication object that is to be displayed in the *Chart* window from a list. WinScope automatically sets the other values of the communication object in the window *Add channel*.
- **Data len**  
Enter how many bytes a data element of the selected communication should consist of.
- **Decimals**  
For a correct display, enter how many decimal places the values of the selected communication object have (e. g. 0 for "123", 1 for "12.3", 2 for "1.23").
- **Format**  
Enter the format with which the communication object is to be displayed.  
The following formats are available:
  - **Value**  
WinScope shows the output value as decimal number.
  - **Binary**  
WinScope shows the output value as binary number.
  - **StringList**  
WinScope shows the output value as so-called string list.
- **Name**  
Enter a name for the channel. The display name is entered automatically once you have selected the communication object via the window *Select com. object*. If necessary, you can change the display name of the channel via this entry.
- **Dim**  
Enter the unit (e. g. °C, mbar, %) with which the values of the communication object are to be displayed.
- **Signed**  
Check *Signed*, if the data elements of the selected communication object are signed, i. e. can have negative values.
- **Bit index enabled**  
In case of binary output values, you can check *Bit index enabled* to be able to select the bit that is to be displayed in the legend as output value.

## 8 SETTINGS VIA WINSCOPE

- **Bit index**

If *Bit index enabled* has been checked, you can select the relevant bit that is to be displayed in the legend as output value.

### Curve

- **High**

Enter the highest scale value of the selected communication object that is to be displayed on the y-axis of the runtime data in the *Chart* window.

- **Offset**

If necessary, enter the offset with which this channel is to be displayed in the *Chart* window.

- **Low**

Enter the lowest scale value of the selected communication object that is to be displayed on the y-axis of the runtime data in the *Chart* window.

- **Color**

Using the button , select the color with which this channel is to be displayed in the *Chart* window.

### Limits

In this area, the threshold values of the channel are configured for the automatic mode of the runtime data recording. Automatic runtime data recording is started via the tool and menu bar of the main view. For more information read the section *Menu Bar and Toolbar* on page 48.

- **Auto start scope**

Select the value range upon reaching WinScope is to begin the runtime data recording in automatic mode.

- **Auto stop scope**

Select the value range upon reaching WinScope is to end the runtime data recording in automatic mode.

The value range is entered in the functions *Auto start scope* and *Auto stop scope* as follows:

- **Cross**

Set in each case for *Auto start scope* and *Auto stop scope* whether the threshold (*Limit*) must be exceeded or fall below. The following parameters are available:

- **Up**

The threshold must be exceeded.

- **Down**

The threshold must fall below.

- **None**

The function is deactivated.

- **Limit**

Enter in each case the threshold (*Limit*) for the function.

– Show limit in chart

Activate the checkbox if the threshold (*Limit*) is to be graphically displayed for each function in the runtime diagram of the *Chart* window.

You can setup up to 32 channels.

### 8.11.3 Editing Channels

The channels that have already been configured in the *Channels* window can be edited via the window *Edit channel*. There are two ways of opening the window:



- Mark the channel in the *Channels* window that you want to edit and click the left symbol.
- Double-click on the channel that you want to edit in the *Channels* window.

The number of the channel that you are currently editing is shown in the title bar behind *Edit channel* (Channel 1 in the above picture).

The editing of the input boxes corresponds to the window *Add channel*. Read the section *Adding Channels* on page 82 for more information.

# 8 SETTINGS VIA WINSCOPE

## 8.12 Period Window

Via the *Period* window, you configure the interval with which WinScope scans the activated channels during the runtime data recording in the *Chart* window. Additionally, statistical data is shown. From the main view, you open the window via:



Scope -> Period

You can choose between two views:

Detailed view

Requested period: [ms]	10	Apply
<<<		
Total samples	3335 of 3338	
Elapsed time	0:00:33.343	
Last period	15	
Last average period	10	
Max period	16	

Reduced view



switches to reduced view



switches to detailed view

The following settings can be made:

- **Requested period: [ms]**  
Via this entry, you define the scanning interval of the runtime data recording in milliseconds. You can enter any values between 1 and 1,000,000,000 milliseconds. A preselection of values is available via . WinScope adopts the value entered by clicking *Apply*. If you have loaded a runtime data recording, this entry shows the average scanning interval of the recording loaded if you have not changed the interval.

In addition, the following information is shown in the detailed view:

- **Total samples**  
Number of scans currently stored in the memory.
  - Left number: number of successful scans
  - Right number: number of requested scans
- **Elapsed time**  
Shows the time elapsed from the start of the runtime data recording during a runtime data recording.

- **Last period**  
Shows the interval in milliseconds between the last two readouts during a runtime data recording.
- **Last average period**  
Shows the average interval in milliseconds of the last readouts during a runtime data recording.
- **Max period**  
Shows the maximum measurement interval in milliseconds between two readouts within the recorded data during a runtime data recording.

### Possible Problems

Scans that cannot be successfully completed during the set interval are indicated by a red-marked data line as in the following example:

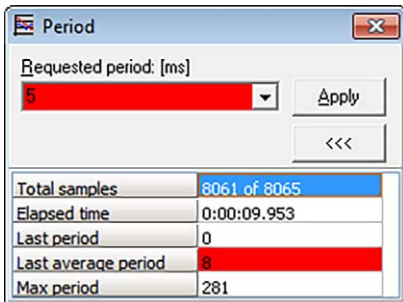

Possible causes can be:

- Loss of connection
- too many active channels or scan interval too short  
The number of channels scanned is too high for the set interval. In this case, one of the following measures can help:
  - Reduce the number of active channels.
  - Increase the scan interval.

# 8 SETTINGS VIA WINSCOPE

## 8.13 Chart Window

The *Chart* window shows the runtime data of the channels that you have configured and activated via the *Channels* window. From the main view, you open the window via:



Scope -> Chart

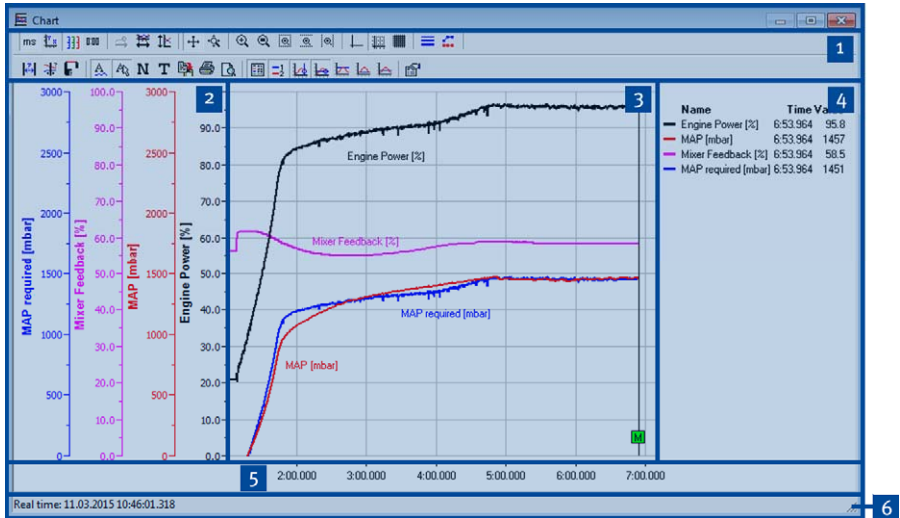

The window is divided into the following areas:

### Toolbar **1**

For a description of the functions available in the *Chart* window via the toolbar, read the section *Toolbar* on page 90.

### Value axis **2**

Display of one or more value scales of parameters on the y-axis

### Display area **3**

The parameter curves and optionally an editable title are shown in this area. The displayed stamps mean the following:



Indicates the beginning and the end of a runtime data recording in manual or automatic mode.



Indicates that at this point a threshold for the recording of runtime data was reached in automatic mode.



Indicates that a parameter was changed at this point.



If you click the stamp when the function *Select and move annotations* is activated (see *Toolbar* on page 90), you receive more information on the stamp.

#### Legend (optional) 4

You can obtain detailed information on the parameter curves via the legend that can be shown or hidden.

#### Time axis 5

Display of the time segment on the x-axis over which the parameter curves are distributed.

#### Status bar 6





Display of the current date and current time during a runtime data recording

Read the section *Channels Window* on page 78 for information on the *Channels* window.

# 8 SETTINGS VIA WINSCOPE







## 8.13.1 Toolbar









The following functions are available via the icons in the toolbar. WinScope shows the designation of the function as soon as you hold the mouse above the corresponding symbol.

Symbol	Designation	Function
	<i>Time format</i> <i>H:MM:SS/M:SS.MSS</i>	Sets the time resolution on the x-axis: <ul style="list-style-type: none"><li>– Off: Display as hours, minutes, seconds</li><li>– On: Display as minutes, seconds, milliseconds</li></ul>
	<i>Axes settings</i>	Opens the <i>Axes</i> window via which the scaling of the axes is changed. The standard values for axis scaling are simultaneously determined with the setting you make in the <i>Axes</i> window. The section <i>Setting Axes Scaling</i> on page 95 contains more information.
	<i>Individual channel axes on/off</i>	Adjusts the representation of the y-axis: <ul style="list-style-type: none"><li>– Off: WinScope displays a standard value scale for all channels on the y-axis. This standard value scale distributes the individual value ranges of the channels on a scale from 0 to 100. The value distribution for each channel refers to the settings of the parameters <i>Low</i> and <i>High</i> in the <i>Channels</i> window.</li><li>– On: WinScope displays for each channel a value axis with its specific value range on the y-axis. The value range to be displayed in the <i>Channels</i> window is determined by the parameters <i>Low</i> and <i>High</i>.</li></ul>
	<i>Reset axes to defaults</i>	Resets the scaling of the time axis (x-axis) and the value axis (y-axis) to the default values determined in the <i>Axes</i> window.  Also resets the start time of the time display to 0.  The section <i>Setting Axes Scaling</i> on page 95 contains more information.
	<i>Time tracking on/off</i>	Adjusts the behavior of the time axis (x-axis) during runtime data recording. <ul style="list-style-type: none"><li>– Off: The section of the time axis does not change during runtime data recording so that you only see the recorded values of the set section. However, the section can be changed manually during recording.</li><li>– On: The section of the time axis shifts automatically during runtime data recording so that the currently recorded values are always visible.</li></ul>







Symbol	Designation	Function
	<i>Zoom time to fit all data</i>	Clicking this button sets the section on the time axis (x-axis) that way that the complete period of the recorded runtime data is displayed in the runtime diagram.
	<i>Zoom Y axis to fit all data</i>	Clicking this button sets the section on the value axis (y-axis) that way that the complete period of the recorded runtime data is displayed in the runtime diagram.
	<i>Set axes to scroll mode</i>	<p>When the button is pressed in, the axes are in scroll mode. The zoom mode is switched off.</p> <p>Scroll mode: When the left mouse button is held down, moving the cursor over the axis legend causes the section to be moved correspondingly to the left or right on the x-axis or upwards or downwards on the y-axis.</p>
	<i>Set axes to zoom mode</i>	<p>When the button is pressed in, the axes are in zoom mode. The scroll mode is switched off.</p> <p>Zoom mode: When the left mouse button is held down, moving the cursor over the axis legend leads to zooming in on the value range of the section (movement of the cursor upwards or to the right) or zooming out of the value range (movement of the cursor downwards or to the left).</p>
	<i>Zoom in</i>	Zooms into the period displayed on the x-axis.
	<i>Zoom out</i>	Zooms out of the period displayed on the x-axis.
	<i>Set zoom box mode</i>	When the button is pressed in, the section of both axes can be changed by drawing a box with the mouse. To draw a box, hold down the left mouse button.
	<i>Set X axis zoom box mode</i>	When the button is pressed in, the section of the time axis (x-axis) can be changed by drawing a box with the mouse. To draw a box, hold down the left mouse button.
	<i>Set Y axis zoom box mode</i>	When the button is pressed in, the section of the value axis (y-axis) can be changed by drawing a box with the cursor. To draw a box, hold down the left mouse button.
	<i>Grid off</i>	When the button is pressed in, WinScope does not display any background grid in the runtime diagram.

## 8 SETTINGS VIA WINSCOPE

Symbol	Designation	Function
	<i>Thin grid</i>	When the button is pressed in, WinScope displays a thin background grid in the runtime diagram.
	<i>Dense grid</i>	When the button is pressed in, WinScope displays a dense background grid.
	<i>Set line width</i>	Opens a window with which the line width of the process curves can be set. Three levels can be selected.
	<i>Value markers on/off</i>	When the button is pressed in, WinScope marks every value scan on the process curve with a vertical mark.
	<i>Measure time on/off</i>	<p>When the button is pressed in, WinScope displays two timelines as vertical black lines with which the time interval can be measured.</p> <p>If you make the measurement for all channels, WinScope displays the time interval in the legend in the <i>Time</i> column.</p> <p>If you make the measurement for an individual channel (double-click on the channel name in the legend), WinScope shows the time interval between the timelines.</p> <p>Both timelines can be shifted by clicking the desired line with the left mouse button and holding down the mouse button during the movement.</p>
	<i>Measure values on/off</i>	<p>When the button is pressed in, WinScope displays a measurement line in the runtime diagram as vertical black line with which the values of all displayed channels on the position of the measurement line can be displayed in the legend.</p> <p>The measurement line can be shifted by clicking the left mouse button and holding down the mouse button during the movement.</p>

Symbol	Designation	Function
	<i>Select data part for saving</i>	When the button is pressed in, WinScope displays two timelines as vertical black lines. By using these timelines you can determine an area of the runtime diagram that is to be saved via the function <i>Save selected data to file</i> in the main view (see <i>Main View</i> on page 46).  Both timelines can be shifted by clicking the desired line with the left mouse button and holding down the mouse button during the movement.
	<i>Channel annotations on/off</i>	When the button is pressed in, WinScope displays the names of the channels in the runtime diagram.
	<i>Select and move annotations</i>	With the button pressed in, the names of the channels in the runtime diagram can be moved by clicking the name with the left mouse button and holding it down during the movement.
	<i>Notepad</i>	When the button is pressed in, WinScope displays the field <i>Comment</i> in the <i>Chart</i> window in which for example notes or remarks on the file can be filed. If you save the runtime data with WinScope as <i>WinScope data file</i> (*.SDT), the entries in this field are also saved.
	<i>Edit chart title</i>	Opens the window <i>Edit chart title</i> with which you can enter or change a title for the runtime diagram.
	<i>Copy snapshot to clipboard</i>	Copies a screenshot of the current view of the <i>Chart</i> window to the memory of your Windows® operating system.
	<i>Print</i>	Opens the Windows® print dialog with which you can print out the current view.
	<i>Print preview</i>	Opens the window <i>locomp Plot Preview</i> with the print preview. The print layout can be changed via the print preview.
	<i>Legend table on/off</i>	When the button is pressed in, WinScope displays a legend as table to the right of the process diagram.

## 8 SETTINGS VIA WINSCOPE

Symbol	Designation	Function
	<i>Legend lines on/off</i>	<p>Defines whether WinScope should display an example line in the legend for each channel.</p> <ul style="list-style-type: none"> <li>– Off: WinScope does not show any example lines and displays the channel name in the display color of the channel.</li> <li>– On: WinScope shows an example line in the display color of the channel in the legend and displays the channel name in black.</li> </ul>
	<i>Current time on/off</i>	<p>When the button is pressed in, WinScope displays the time of the last scan in the legend column <i>Time</i>.</p> <p>This button cannot be deactivated as long as the measurement line is displayed (see <i>Measure values on/off</i>).</p>
	<i>Current values on/off</i>	<p>When the button is pressed in, WinScope displays the last scanned value for each channel in the legend column <i>Value</i>.</p> <p>This button cannot be deactivated as long as the measurement line is displayed (see <i>Measure values on/off</i>).</p>
	<i>Max values on/off</i>	<p>When the button is pressed in, WinScope displays the highest value of all scans from the beginning of the recording in the legend column <i>Max</i> for each channel.</p>
	<i>Min values on/off</i>	<p>When the button is pressed in, WinScope displays the lowest value of all scans from the beginning of the recording in the legend column <i>Min</i> for each channel.</p>
	<i>Average values on/off</i>	<p>When the button is pressed in, WinScope displays the average value of all scans from the beginning of the recording in the legend column <i>Avg</i> for each channel.</p>
	<i>Advanced settings</i>	<p>Opens the <i>Plot</i> window via which advanced settings can be made for the graphic display in the <i>Chart</i> window.</p> <p>This button is only available if in the <i>Options</i> window on the <i>General</i> tab the checkbox <i>Allow advanced chart settings</i> is activated (see <i>Options Window</i> on page 96).</p> <p>Alternatively, you can open the <i>Plot</i> window by clicking the right mouse button in the runtime diagram and selecting the option <i>Edit</i>.</p>

### 8.13.2 Setting Axes Scaling

You define the standard values for the scaling of the x- and y-axes via the *Axes* window.



To open the *Axes* window, click the left symbol in the *Chart* window.

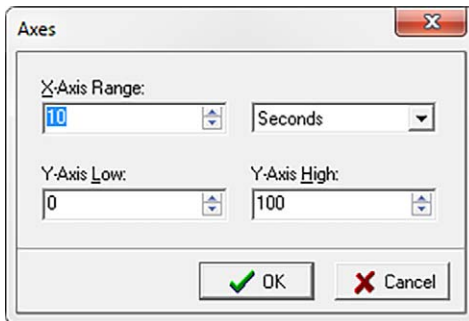

You can make the following settings:

- **X-Axis Range**  
Enter the standard length of the period that is to be represented on the x-axis. With the right selection field you can select hours (*Hours*), minutes (*Minutes*) or seconds (*Seconds*) as time unit.
- **Y-Axis Low**  
The lowest scale values to be displayed of all channels (parameter *Low* in the *Channels* window) are defined by *Y-Axis Low*. Using *Y-Axis Low*, enter the value which is to be displayed as lowest scale value when the standard value axis is shown. The default setting is 0 (zero).
- **Y-Axis High**  
The highest scale values to be displayed of all channels (parameter *High* in the *Channels* window) are defined by *Y-Axis High*. Using *Y-Axis High*, enter the value which is to be displayed as highest scale value when the standard value axis is shown. The default setting is 100.

By clicking the *OK* button, WinScope saves the default values and applies them to the runtime diagram in the *Chart* window. By using the button *Reset axes to defaults* in the *Chart* window, you can reset the scaling of the runtime diagram to the standard values at any time (see *Chart Window* on page 88).

# 8 SETTINGS VIA WINSCOPE

## 8.14 Options Window

The *Options* window lets you perform the basic settings to operate WinScope. From the main view, you open the window via:

*Scope* -> *Options*

The following three tabs are available to you in the *Options* window:

- General
- Data capacity
- User dongle

### General

You can make the general settings for WinScope via the *General* tab.

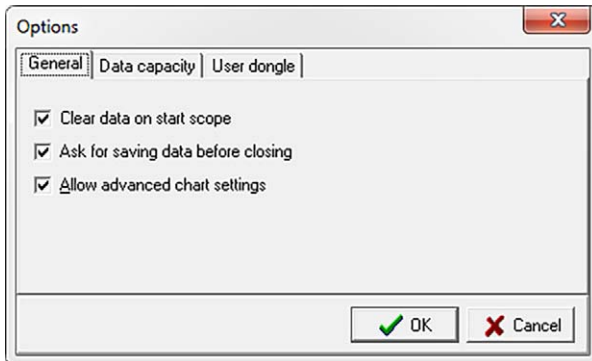

The following options are available:

- **Clear data on start scope**  
When the checkbox is activated, WinScope deletes all runtime data in the *Chart* window at the beginning of a runtime data recording. When the checkbox is deactivated, WinScope places a gap at the end of the currently loaded recording and continues the runtime data recording there.
- **Ask for saving data before closing**  
When opening a runtime data file (\*.SDT), WinScope deletes all runtime data in the *Chart* window. When the checkbox is activated, WinScope asks before each opening of a runtime data file whether the runtime data in the *Chart* window should be saved in advance.
- **Allow advanced chart settings**  
When the checkbox is activated, the button *Advanced settings* is in addition available to you in the *Chart* window (see *Chart Window* on page 88). Via the button *Advanced settings*, you can open the *Plot* window with which you can make advanced adjustments to the graphic display of the *Chart* window.



## Data capacity

The *Data capacity* tab lets you adjust the size of the runtime data memory.

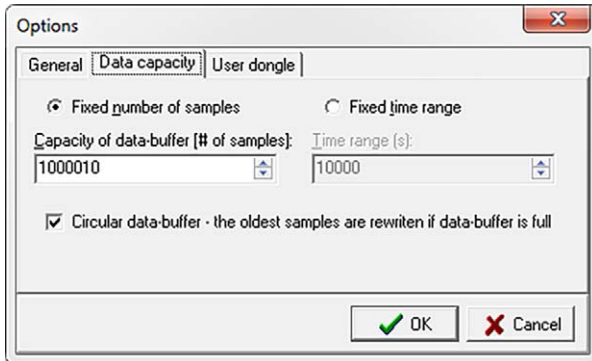

There are two ways of limiting the runtime data memory:

1. You define the maximum number of scans to be recorded by WinScope (option *Fixed number of samples*).
2. You set the maximum period that is to be available for a runtime data recording (option *Fixed time range*).

In addition, you define the behavior of WinScope for when a runtime data recording has exceeded the available data memory.

You can make the following settings:

- **Fixed number of samples**  
When selecting this option, you set via *Capacity of data-buffer [# of samples]* how many scans at most WinScope should record and preserve in the runtime data memory.
- **Fixed time range**  
When selecting this option, you set the maximum period that WinScope is to record and preserve runtime data in the memory via *Time range (s)*.
- **Circular data-buffer**  
If the checkbox is activated, WinScope continues the recording with a full runtime data memory, but old data is constantly deleted. If the checkbox is deactivated, WinScope ends the runtime data recording as soon as the runtime data memory is full.

## User dongle

The *User dongle* tab is not used in connection with the EmCon5.

# 9 OPERATION

## 9.1 Start-up



### Risk of destruction!

Incorrect configuration of the EmCon5 may lead to serious damage to the engine. Consequently, the EmCon5 may only be configured by trained, authorized personnel. If you have any questions, contact your MOTORTECH contact partner (see *Customer Service Information* on page 107).

Damage caused by incorrect configuration is not covered by warranty.

Before you put the EmCon5 emission controller into operation, take note of the following:

- Ensure that the EmCon5 is wired correctly with the following components:
  - Control unit of the air/gas mixer (stepper motor driver)
  - Sensors for manifold pressure, manifold air temperature and optionally methane
  - Feedback signal of engine power from the engine
  - Optional: Feedback signal of the mixer position from the air/gas mixer
  - Optional: Master control
  - Power supply

Read the section *Wiring of the Device* on page 28 for more information on wiring.

- Ensure the following for the analog sensor inputs:
  - Are the jumpers set correctly for the measurands at the inputs (see *Set Jumpers* on page 29)?
  - Are the correct signal and measurement value ranges configured via WinScope (see *Sensor Chars Group* on page 57)? Are the current measurement values correctly displayed in WinScope?
- Set the fixed mixer positions and the manifold pressure characteristic suitable for your gen-set. The section *Configuring Mixture Control* on page 99 contains more information.
- Check whether the EmCon5 drives to the fixed mixer positions correctly.
- When using a methane sensor in the control modes *ENA-FIX* and *ENA-STEP*: Has the characteristic for the adjustment of the fixed mixer positions to the methane content been correctly configured via WinScope (see *Setting the Characteristic for the Methane Content Adjustment* on page 66)?
- Check whether the following control parameters and functions have been set up correctly via WinScope:
  - maximum permissible manifold pressure deviation (see *Setting Manifold Pressure Control* on page 76)
  - maximum permissible period that the signal of the manifold pressure sensor may deviate from the operating range (see *Error Detection at Sensor Inputs* on page 62)

- maximum permissible manifold air temperature (see *Setting Manifold Air Temperature Control* on page 77)
- Position control (see *Setting Position Control* on page 73)
- Optional: Correction of the target manifold pressure in the event of misfires (see *Setting Misfire Correction* on page 76)
- Check whether the mixture control mode that suits the application has been set via WinScope (see *Setting Mixture Control Mode* on page 72).

## 9.2 Configuring Mixture Control

The optimal fixed mixer positions and manifold pressure characteristic suitable for the engine must be determined and configured before the EmCon5 can be put into operation.

Preparation:

- An exhaust gas tester is required to set the mixture control.
- Find out from the manufacturer of the engine what nitrogen oxide emission values and exhaust gas temperatures represent an optimal air/fuel ratio in lean operation.
- Set via WinScope the mixture control mode of the EmCon5 to **MANUAL** (see *Setting Mixture Control Mode* on page 72).

Proceed as follows:

1. Determine start position
  - Try out the different mixer positions until the engine starts (see *Setting Manual Mixer Position* on page 73).
  - Configure this position as start position (*Start pos x*; see *Setting Fixed Mixer Positions* on page 68).
2. Determine run position
 

Normally, uninterrupted idling of the engine is possible at the start position of the mixer, but the engine may not run quietly or the exhaust gas temperature may be too high.

  - Change the mixer position in steps by 0.1 %. Test at which position the engine runs quietly with the best possible exhaust gas temperature.
  - Configure this position as run position (*Run pos x*).
3. Determine low power position
  - Synchronize the generator to the mains and load the gen-set with about 10 % of the nominal power after closing the generator circuit breaker.
  - Test at which position the engine runs quietly with the best possible exhaust gas temperature.
  - Measure the nitrogen oxide emissions and change the mixer position if necessary.
  - Check the position of the throttle. Make sure that the throttle still has adequate room for maneuver before the gen-set is at full load.

## 9 OPERATION

- Repeat the tests for different loads below the power-dependent control range.
  - Configure the position determined as low power position (*Low Pwr pos x*).
4. Determine manifold pressure characteristic
- Carry out five measurements with increasing loads at constant manifold air temperature to determine the manifold pressure characteristic. Cover the range up to full load. Reduce the distances in the setpoints upwards.
  - Ensure that the manifold pressure of the first setpoint and all succeeding setpoints is above the static pressure and as a result generates positive charging pressure. Moreover, the minimum load of the gen-set must lie at least 5 percentage points above the first setpoint.
  - Measure the nitrogen oxide emissions and the exhaust gas temperature and adjust the mixer position for each load.
  - Note the engine power and manifold pressure (MAP) for each measured point. Also make a note of the reference manifold air temperature of the manifold pressure characteristic.

### Example

Manifold absolute pressure (MAP)

mbar

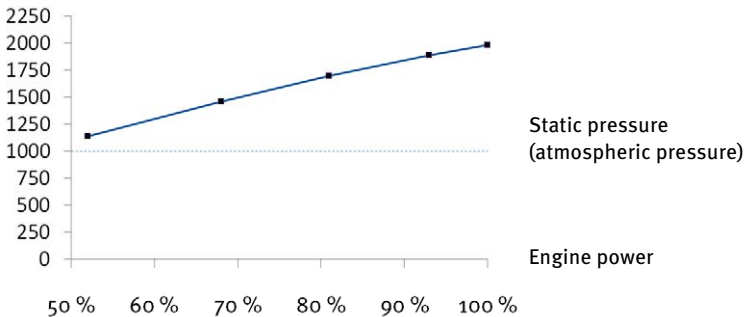

- Stop the engine after you have completed the measurements.
- If necessary, repeat the measurements for a different manifold air temperature in order to use this comparative measurement to determine the *MAT correction* factor.

## 5. Configure manifold pressure characteristic

- Use WinScope to configure the manifold pressure characteristic with the five setpoints including the reference temperature and the correction factor *MAT correction* (see *Configuring Manifold Pressure Characteristic* on page 69).
- First, set the control parameter *AFR gain* to 20 % and the control parameter *AFR int* to 10 % (see *Setting Control Parameters of the Power-Dependent Mixture Control* on page 72).

## 6. Check power-dependent air/fuel mixture control

- Set via WinScope the mixture control mode of the EmCon5 to *AUTOMATIC*.
- Start the engine and check all relevant measurement values in idle including nitrogen oxide emissions, exhaust gas temperature and manifold pressure.
- Load the gen-set.
- Check in steps all relevant measurement values at rising loads including nitrogen oxide emissions, exhaust gas temperature and manifold pressure. Make in particular sure that the measured manifold pressure values correspond to the manifold pressure characteristic.
- If necessary, adjust the control parameters *AFR gain* and *AFR int*.
- The configuration is optimal if the manifold pressure target value *MAP required* has balanced within three minutes in power-dependent air/fuel mixture control.

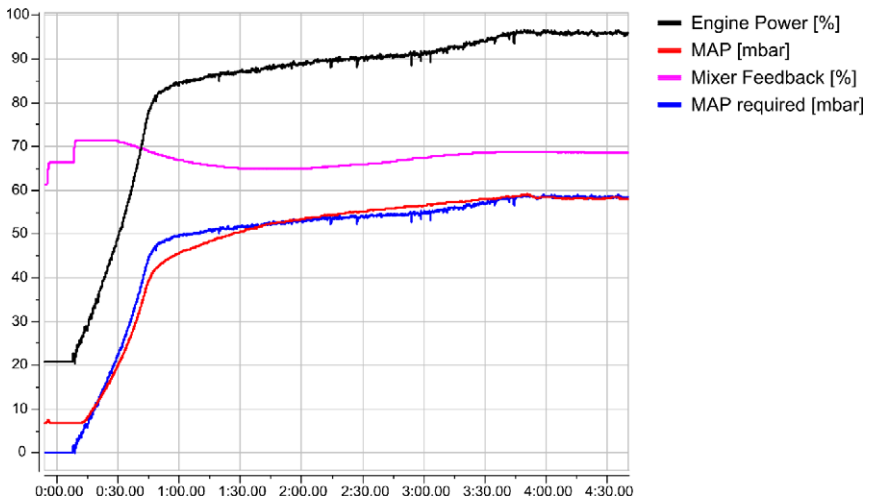

## 9.3 Shutdown

The emission controller is shut down by disconnecting it from the power supply.

# 10 FAULTS

## 10.1 Error Overview

The EmCon5 can signal the following error states via the red error status LEDs on the device:

Error	Control LEDs						Binary outputs			
	Control Error	Sensor Error	Mixer	Engine Power	MAP	MAT	%CH <sub>4</sub>	Mixer Warning	MAT Warning	Alarm
Sensor error										
Input <i>Mixer Feedback</i>		●	●							●
Input <i>Engine Power</i>		●		●						●
Input <i>MAP</i>		●			●					●
Input <i>MAT</i>		●				●				●
Input <i>%CH<sub>4</sub></i>		●					●			●
Other errors										
Manifold pressure control error	●									●
Manifold air temperature warning									●	●
Mixer control warning								●		●
Setpoints checksum error		●								●

### Behavior of the LEDs

- LED flashing: An error has occurred, which has not yet been acknowledged.
- LED permanently illuminated: An error that has been acknowledged still exists.
- Multiple error states may be displayed in parallel.

Information on error acknowledgement is available in the section *Acknowledging Errors* on page 104.

### Error States

The EmCon5 signals the following errors states via LEDs on the device:

- Sensor error  
There is a signal on the relevant sensor input that is 5 percentage points or more outside of the defined operating range and has exceeded a particular maximum permissible period.

- Manifold pressure control error  
The maximum permissible deviation of the current manifold pressure from the manifold pressure target value was exceeded for the maximum permissible period.
- Manifold air temperature warning  
The maximum permissible manifold air temperature was exceeded for the maximum permissible period.
- Mixer control warning  
The maximum permissible difference between the targeted mixer position and the position reported back via the *Mixer Feedback* input was exceeded for the maximum permissible period.
- Setpoints checksum error  
The checksum of the configuration is defective.

### Error Reading by Connected Devices

The EmCon5 signals the manifold air temperature warning (*MAT Warning*) and mixer control warning (*Mixer Warning*) via the binary outputs to a connected device, for example a master control.

More error states can be read out by connected devices via the CAN bus by querying the communication object *AIN Status*. The error states are signaled as follows via the bits of *AIN Status*:

Bit	Status	Bit = 0	Bit = 1
0	Input <i>Mixer Feedback</i>	In permissible range	Sensor error
1	Input <i>Engine Power</i>		
2	Input <i>MAP</i>		
3	Input <i>MAT</i>		
4	Input <i>%CH<sub>4</sub></i>		
8	Manifold pressure (MAP)		Control error
9	Manifold air temperature (MAT)		
10	Mixer position	Within tolerance	
15	Setpoints checksum	Checksum valid	Checksum error

Alternatively the communication object *AIN Status* can also be queried and displayed via the configuration and monitoring software WinScope. For this purpose, set up the communication object *AIN Status* as a channel in the *Channels* window. More information is available on setting up channels in the section *Channels Window* on page 78.

For more information on the CAN bus, refer to the EmCon5 CAN Bus Documentation, which is available on the storage device (USB flash drive or CD-ROM) enclosed with the device.

# 10 FAULTS

## WinScope Error Messages

If the WinScope configuration software is connected to the EmCon5, the WinScope software indicates connection errors to the device via the *Messages* window. For more information on this read the section *Messages Window* on page 51.

### 10.2 Acknowledging Errors

A new error state is indicated by the flashing of the relevant error status LED. The LEDs flash until the error is acknowledged by closing the *Alarm Reset* input for at least 100 ms, for example by a master control.

If the error state no longer exists as it is acknowledged, the relevant LEDs go out. The same test periods apply to an error state no longer being recognized as to the recognition of an error.

If the error state still exists as it is acknowledged, the relevant error state LED changes to permanent illumination. In this case, the LEDs only go out once the EmCon5 has determined that the error state no longer exists.

The following example illustrates the mode of operation of the error acknowledgement.





### Mode of operation of error acknowledgement

The following example illustrates the mode of operation of error acknowledgement in the EmCon5 on the basis of two error states that occur successively.

Event	Behavior of the LEDs
Error-free operation	All LEDs are off.
The maximum permissible manifold air temperature ( <i>MAT</i> ) is exceeded.	<i>Alarm</i> : flashing <i>MAT Warning</i> : flashing
The error is acknowledged via the <i>Alarm Reset</i> input.	<i>Alarm</i> : permanently illuminated <i>MAT Warning</i> : permanently illuminated
The EmCon5 detects a sensor error at the <i>MAP</i> input.	<i>Alarm</i> : flashing <i>MAT Warning</i> : permanently illuminated <i>Sensor Error</i> : flashing <i>MAP</i> : flashing
The current manifold air temperature ( <i>MAT</i> ) falls and is in the permissible range for the set period <i>MAT Wrn del</i> again.	<i>Alarm</i> : flashing <i>MAT Warning</i> : off <i>Sensor Error</i> : flashing <i>MAP</i> : flashing
The new error (sensor error at <i>MAP</i> input) is acknowledged via the <i>Alarm Reset</i> input.	<i>Alarm</i> : permanently illuminated <i>MAT Warning</i> : off <i>Sensor Error</i> : permanently illuminated <i>MAP</i> : permanently illuminated

# 10 FAULTS

## 10.3 Possible Faults

### **Sensor error**

The sensor input shows measured values that deviate more than 5 percentage points from the configured operating range.

Potential causes:

- Operating range of the unit connected to the input not configured correctly in the EmCon5
- Interference in the unit wiring
- Unit wiring incorrect
- Incorrect jumper position on the EmCon5 board
- Unit defective

### **Manifold pressure control error**

There is an impermissible deviation in the current manifold pressure from the manifold pressure target value.

- Manifold pressure characteristic not configured to suit the engine
- Position is not correctly approached by the air/gas mixer
- Turbocharger defective
- Leak in the intake manifold

### **Manifold air temperature warning**

The maximum manifold air temperature permissible has been exceeded.

- The temperature in the manifold is too high.
- Interference in the wiring of the temperature sensor
- Temperature sensor not functioning properly

### **Mixer control warning**

There is an impermissible deviation in the mixer position reported back from the targeted mixer position.

Potential causes:

- EmCon5 configuration not adjusted to the hysteresis of the air/gas mixer
- Position is not correctly approached by the air/gas mixer.
- The wiring to the air/gas mixer's stepper motor is defective or incorrect.
- The air/gas mixer wiring is defective or incorrect.
- The stepper motor or the air/gas mixer is defective.

### Setpoints checksum error

The configuration of the EmCon5 in the memory is defective.

Potential causes:

- The configuration was downloaded incorrectly from the computer to the EmCon5.
- The memory chip of the EmCon5 is not working properly or is defective.

## 10.4 Customer Service Information

You can reach our customer service during business hours at the following phone and fax number, or by e-mail:

Phone: +49 5141 93 99 0

Fax: +49 5141 93 99 99

Email: [service@motortech.de](mailto:service@motortech.de)

## 10.5 Returning Equipment for Repair / Inspection

To return the device for repair and inspection, obtain a return form and return number from MOTORTECH.

Fill out the return form completely. The completely filled out return form guarantees fast, uncomplicated processing of your repair order.

Send the device and the return form to one of the two addresses below or to the nearest MOTORTECH representative:

### MOTORTECH GmbH

Hogrevestr. 21-23  
29223 Celle

Germany

Phone: +49 5141 93 99 0

Fax: +49 5141 93 99 98

[www.motortech.de](http://www.motortech.de)  
[motortech@motortech.de](mailto:motortech@motortech.de)

### MOTORTECH Americas, LLC

1400 Dealers Avenue, Suite A  
New Orleans, LA 70123

USA

Phone: +1 504 355 4212

Fax: +1 504 355 4217

[www.motortechamericas.com](http://www.motortechamericas.com)  
[info@motortechamericas.com](mailto:info@motortechamericas.com)

## 10.6 Instructions for Packaging the Equipment

For return shipment, equipment should be packaged as follows:

- Use packaging material that does not damage the equipment surfaces.
- Wrap the equipment with sturdy materials and stabilize it inside the packaging.
- Use sturdy adhesive film to seal the packaging.

# 11 MAINTENANCE

## 11.1 Maintenance Instructions

Please follow the following maintenance instructions:

- Clean the connected sensors at regular intervals.
- Check the measuring precision of the connected sensors regularly according to the manufacturer information.
- Regularly inspect all wires of the EmCon5 for damage and replace the wires as needed.
- Check all plug-in connections regularly for proper condition.
- Regularly check the configuration of the EmCon5 as part of major maintenance work. In particular ensure that the emission values are observed via the configured manifold pressure characteristic.

## 11.2 Spare Parts and Accessories

For spare parts and accessories for the EmCon5, please refer to our current Product Guide, which is available for you to download on the internet at [www.motortech.de](http://www.motortech.de).

# 12 INDEX

<b>%</b>	
%CH <sub>4</sub>	
Control.....	43, 62
Description .....	40
Setting.....	65
Wiring.....	28
<b>A</b>	
Abbreviations.....	7
Alarm	
Acknowledge.....	31, 104
Display.....	102
Analog inputs	
Description .....	40
Electrical data .....	21
Wiring.....	28
Analog mixer control	
Control.....	43, 73
Description .....	42
Setting.....	29
Analog output	
Description .....	40
Electrical data .....	21
Position control.....	43, 73
Wiring.....	28
Assembly	
EmCon5.....	26
Sensors .....	27
<b>B</b>	
Binary mixer control	
Control.....	43, 73
Description .....	42
Binary outputs	
Electrical data .....	21
Wiring.....	31, 33
<b>C</b>	
CAN bus	
Interface .....	22
Setting.....	77
Wiring.....	32
CAN comm .....	77
Certifications .....	19
CH <sub>4</sub>	
Methane content adjustment.....	40
Sensor installation .....	27
Set characteristic.....	66
Set mode .....	74
Channels	
Add.....	82
Description.....	78
Edit .....	85
Toolbar.....	80
Chart	
Description.....	88
Toolbar.....	90
Configuration .....	44
Control.....	43, 67, 73, 75
Create connection.....	50
<b>D</b>	
Declaration of Conformity.....	
Device	
Application range .....	18
Assembly .....	26, 27
Dimensions .....	21, 23
Disposal.....	13
Electrical data.....	21
Function.....	35
Mechanical data .....	21
Return.....	107
Start-up.....	98
Dimensions .....	21, 23
<b>E</b>	
Electrical data.....	
EmCon5 emission controller	
Application range .....	18
Assembly .....	26, 27
Dimensions .....	21, 23
Disposal.....	13
Electrical data.....	21
Function .....	35
Mechanical data .....	21
Return.....	107
Start-up.....	98
Engine Power	
Description.....	40
Setting.....	64
Wiring.....	28
Error	
Acknowledging .....	104
Display.....	102
Recognition .....	43, 62
Reset .....	104

## 12 INDEX

- F**
- Fixed mixer positions
  - Description ..... 39
  - Methane content adjustment ..... 40
  - Setting ..... 68
- Function ..... 35
- G**
- Groups
  - CAN comm ..... 77
  - Control ..... 67
  - Protections ..... 75
  - Sensor chars ..... 57
- I**
- Installation
  - Emission controller ..... 26
  - Sensors ..... 27
- Interfaces ..... 22
- J**
- Jumper ..... 29
- L**
- LED ..... 102
- M**
- Maintenance ..... 108
- Manifold air temperature
  - Control ..... 43, 62, 77
  - Input ..... 40, 65
- Manifold air temperature control
  - Description ..... 43
  - Setting ..... 77
- Manifold pressure
  - Description ..... 43, 62, 76
  - Input ..... 40, 64
- Manifold pressure characteristic
  - Description ..... 38
  - Setting ..... 69
- Manifold pressure control
  - Description ..... 43
  - Setting ..... 76
- MAP
  - Description ..... 40, 43, 62, 76
  - Sensor installation ..... 27
  - Setting ..... 64
  - Wiring ..... 28
- MAT
  - Control ..... 43, 62, 77
  - Description ..... 40
  - Sensor installation ..... 27
  - Setting ..... 65
  - Wiring ..... 28
- Mechanical data ..... 21
- Messages ..... 51
- Methane characteristic
  - Description ..... 40
  - Setting ..... 66
- Methane content adjustment
  - Description ..... 40
  - Setting ..... 66, 74
- Methane sensor, installation ..... 27
- Misfire correction
  - Description ..... 42
  - Setting ..... 76
- Mixer control
  - Control ..... 43, 73
  - Description ..... 42
  - Manual ..... 73
  - Setting ..... 67
- Mixer Feedback
  - Description ..... 40
  - Setting ..... 63
  - Wiring ..... 28
- Mode
  - Methane content adjustment ..... 40, 74
  - Regulation of the air/fuel mixture ..... 37, 72
- MOTORTECH address ..... 107
- O**
- Options ..... 96
- P**
- Password protection ..... 56
- Period ..... 86
- Position control ..... 43, 73
- Power-dependent air/fuel mixture control
  - Description ..... 38
  - Mode ..... 72
  - Setting ..... 67, 99
- Product identification ..... 23
- Product number ..... 23
- Protections ..... 75
- R**
- Regulation of the air/fuel mixture
  - Description ..... 38
  - Mode ..... 72
  - Setting ..... 67, 99
- Regulations ..... 19
- Repair ..... 107
- Required current ..... 21
- Reset alarm ..... 104
- Return shipment ..... 107
- RS232 interface ..... 22, 23

## S

Safety functions	
Description .....	43
Setting .....	73, 75
Safety instructions .....	9, 11
Scope of supply .....	26
Sensor chars .....	57
Sensor inputs	
Description .....	40
Error detection .....	62
Setting .....	57
Signal processing .....	58
Wiring .....	28
Sensors, installation .....	27
Serial number .....	23
Setpoints	
CAN comm .....	77
Control .....	67
Description .....	52
Protections .....	75
Sensor chars .....	57
Toolbar .....	55
Signal processing sensor inputs .....	58
Software	
Activation .....	45
Design .....	46
Installation .....	44
Menu bar .....	48
Operation .....	46
Password protection .....	56
System requirements .....	44
Toolbars .....	48, 55, 80, 90
Start-up .....	98
Supply voltage .....	21, 34

## W

Window	
Channels .....	78
Chart .....	88
Messages .....	51
Options .....	96
Period .....	86
Setpoints .....	52
WinScope	
Activation .....	45
Design .....	46
Installation .....	44
Menu bar .....	48
Operation .....	46
Password protection .....	56
System requirements .....	44
Toolbars .....	48, 55, 80, 90

Wiring .....	28
--------------	----

## Original MOTORTECH® Accessories for Stationary Gas Engines

As a supplier, MOTORTECH develops, produces and distributes accessories as well as spare and wearing parts for nearly all kinds of stationary gas engines worldwide: Ignition control and monitoring, industrial spark plugs and high tension leads, wiring systems and gas regulation – from detonation to speed control up to complete gas engine management. On-site support and special training courses complete our service.



### **MOTORTECH GmbH**

Hogrevestr. 21-23  
29223 Celle  
Germany  
Phone: +49 5141 93 99 0  
Fax: +49 5141 93 99 99  
[www.motortech.de](http://www.motortech.de)  
[motortech@motortech.de](mailto:motortech@motortech.de)

### **MOTORTECH Americas, LLC**

1400 Dealers Avenue, Suite A  
New Orleans, LA 70123  
USA  
Phone: +1 504 355 4212  
Fax: +1 504 355 4217  
[www.motortechamericas.com](http://www.motortechamericas.com)  
[info@motortechamericas.com](mailto:info@motortechamericas.com)