

MIC3+ – Ignition Controller

Operating Manual



P/N 01.10.036-EN | Rev. 07/2021

Original instructions

© Copyright 2021 MOTORTECH GmbH. All rights reserved.

MOTORTECH products and the MOTORTECH logo are registered and/or common law trademarks of the MOTORTECH GmbH. All further trademarks and logos displayed or used in this publication are the property of the respective entitled person and are used for reference purposes only.

Information contained in this publication may be changed without prior notice.

Table of Contents



1 General Information	7
1.1 What Is the Purpose of this Operating Manual?	7
1.2 Who Is this Operating Manual Targeted to?	7
1.3 Which Symbols Are Used in the Operating Manual?	7
1.4 Which Abbreviations/Acronyms Are Used in the Operating Manual?	8
2 Safety Instructions	11
2.1 General Safety Instructions	11
2.2 Electrostatic Discharge Hazards	12
2.3 Information on Electric Isolation	13
2.4 Special Safety Instructions for the Device	15
2.5 Proper Disposal	16
3 Intended Use	17
3.1 Functional Description	17
3.2 Applications	17
4 Product Description	18
4.1 Technical Data	18
4.1.1 Certifications	18
4.1.2 Mechanical Data	19
4.1.3 Warning Notices on the Device	20
4.1.4 Product Identification – Labeling on the Device	21
4.1.5 Electrical Data	21
4.1.6 Interfaces	25
4.1.7 Requirements for External Equipment	25
4.1.8 Overview Drawings	26
4.1.9 LED Functions	28
5 Installation Instructions	31
5.1 Unpacking	31
5.2 Installation of the Ignition Controller	31
5.2.1 Installation of the Vibration Dampers	32
5.2.2 Installation of the Ground Strap	33
5.3 Determine the Installation Location of the Pickup	34
6 Wiring of the Device	35
6.1 Input and Output Wiring on the Controller	35
6.1.1 Input Wiring	36
6.1.2 Input Wiring – Power Supply	37

Table of Contents

6.1.3 Input Wiring – Pickups	39
6.1.4 Input Wiring – Timing and Safety Devices	41
6.1.5 Output Wiring – Binary Outputs (Go/NoGo, GPO, ASO)	44
6.1.6 Wiring – PowerView3	45
6.1.7 Output Wiring – CAN Bus Interface	47
6.1.8 Output Wiring – RS485 Interface.....	49
6.2 Ignition Coil Wiring.....	50
6.3 Straight Order Wiring of the Ignition Outputs	52
7 Functions	55
7.1 Pickup Sensitivity	55
7.2 Monitoring of Pickup Signals.....	55
7.3 Go/NoGo.....	55
7.4 Ignition Timing Adjustment	56
7.4.1 Analog Inputs	57
7.4.2 Cylinder-to-Cylinder Alignment.....	59
7.4.3 Speed Curve.....	59
7.4.4 Ignition Timing Correction	59
7.5 Firing Angle	59
7.6 HV-Power Supply Error Monitoring.....	59
7.7 Output Monitoring	60
7.8 Schedules A/B	60
7.9 Alarms	60
7.10 GPO: General Purpose Output	61
7.11 ASO: Auxiliary Synchronization Output	61
7.12 Ignition Energy	63
7.13 Access Control	63
8 Settings via the MICT	65
8.1 MICT System Requirements	65
8.2 MICT Installation	65
8.3 Access Levels in the MICT	66
8.4 Configuration Pages (Overview)	67
8.5 Menu Bar and Toolbar.....	68
8.6 Online Update Settings	71
8.7 Self Test	72
8.8 Pickup Trace	74
8.9 Access Control for MIC3+	76
8.9.1 Enable/Disable Access Control	76

Table of Contents



8.9.2	Login/Logout	77
8.9.3	Changing the PIN.....	77
8.9.4	Reset all PINs	77
8.10	Working with Configurations	78
8.10.1	Create, Open, Save.....	79
8.10.2	Upload, Download	80
8.10.3	Compatibility Information.....	81
8.11	Configuration.....	82
8.11.1	Engine – Parameters	83
8.11.2	Engine – Cylinder Names	86
8.11.3	Engine – Ignition Outputs	87
8.11.4	Engine – Ignition Coils.....	89
8.11.5	Engine – Pickups.....	91
8.11.6	Timing – Analog Inputs	95
8.11.7	Timing – Schedule A/B – General	97
8.11.8	Timing – Schedule A/B – Energy	99
8.11.9	Timing – Miscellaneous	100
8.11.10	Inputs/Outputs – Alarms.....	101
8.11.11	Inputs/Outputs – ASO1 (Auxiliary Synchronization Output).....	103
8.11.12	Inputs/Outputs – Inputs.....	105
8.11.13	Miscellaneous – Communication	106
8.11.14	Miscellaneous – Information	108
8.12	Runtime Data.....	109
8.12.1	Runtime Data – Overview	110
8.12.2	Runtime Data – Timing	113
8.12.3	Runtime Data – Ignition.....	114
8.12.4	Runtime Data – Bank A.....	115
8.12.5	Runtime Data – States.....	117
8.12.6	Runtime Data – Message Log.....	123
8.12.6.1	Information.....	125
8.12.6.2	Warnings.....	127
8.12.6.3	Alarms	128
8.12.6.4	Failure.....	129
8.12.7	Runtime Data – Diagnostics	133
8.12.8	Runtime Data – Temperatures.....	135
8.12.9	Runtime Data – Information.....	136
8.13	Log	137
8.14	Runtime Adjustments.....	138
8.14.1	Runtime Adjustments – Reset.....	139

Table of Contents

8.14.2	Runtime Adjustments – Timing	140
8.14.3	Runtime Adjustments – Energy	141
8.14.4	Runtime Adjustments – Secondary Voltage Calibration	142
8.14.5	Runtime Adjustments – Secondary Short Calibration	143
8.15	Cylinder Individual Offsets	144
8.16	Schedule Curve	145
8.16.1	Schedule Curve – Simulation	145
8.16.2	Schedule Curve – Runtime Values	147
8.17	Coils	148
8.17.1	General	149
8.17.2	Min. Energy Limit Curve	151
9	Operation	152
9.1	Start-up	152
9.2	Shutdown	153
9.3	Firmware Update	153
10	Errors	157
10.1	Possible Faults	157
10.2	Causes of Faults	157
10.2.1	Overspeed	157
10.2.2	Output Error Detection	157
10.2.3	Misfire Detection (Primary)	158
10.2.4	Pickup Input Errors	158
10.2.5	Acknowledging Faults	158
10.3	Troubleshooting	159
10.3.1	Running a Self Test	159
10.3.2	Customer Service Information	159
10.3.3	Returning Equipment for Repair / Inspection	160
10.3.4	Instructions for Packaging the Equipment	160
11	Maintenance	161
11.1	Maintenance Instructions	161
11.2	Spare Parts and Accessories	161
12	Index	162

1 General Information



Read through this operating manual carefully before use and become familiar with the product. Installation and start-up should not be carried out before reading and understanding this document. Keep this manual readily available so that you can reference it as needed.

1.1 What Is the Purpose of this Operating Manual?

This manual serves as an aid for the installation and operation of the product and supports the technical staff with all operating and maintenance tasks to be performed. Furthermore, this manual is aimed at preventing dangers to life and health of the user and third parties.

1.2 Who Is this Operating Manual Targeted to?

The operating manual provides a code of conduct for personnel tasked with the setup, operation, maintenance, and repair of gas engines. A certain level of technical knowledge with respect to the operation of gas engines and basic knowledge of electronic ignition systems are necessary. Persons who are only authorized to operate the gas engine shall be trained by the operating company and shall be expressly instructed concerning potential hazards.

1.3 Which Symbols Are Used in the Operating Manual?

The following symbols are used in this manual and must be observed:



Example

This symbol indicates examples, which point out necessary handling steps and techniques. In addition, you receive additional information from the examples, which will increase your knowledge.



Notice

This symbol indicates important notices for the user. Follow these. In addition, this symbol is used for overviews that give you a summary of the necessary work steps.



Warning

This symbol indicates warnings for possible risks of property damage or risks to health. Read these warning notices carefully and take the mentioned precautionary measures.

1 General Information



Danger

This symbol indicates warnings for danger to life, especially due to high voltage. Read these warning notices carefully and take the mentioned precautionary measures.

1.4 Which Abbreviations/Acronyms Are Used in the Operating Manual?

In the manual or the user interface, the following abbreviations / acronyms are used.

Abb.	Term	Description	Explanation
ADV	Advance	Advanced with respect to top dead center	Indicates the direction for timing
ASO	Auxiliary Synchronization Output		Output for synchronizing the MIC ₃₊ and other controllers
ATDC	After Top Dead Center		
BTDC	Before Top Dead Center		
CAN bus	Controller Area Network bus	Bus for control devices/networks	Asynchronous serial connection system for linking control units
CE	Conformité Européenne	Conformity with EU directives	Mark based on EU legislation for certain products in conjunction with product safety
CPU	Central Processing Unit		
°crankshaft	Degree crankshaft		Unit for the rotation angle of the crankshaft
CSA	Canadian Standards Association		Organization that defines standards, inspects products for safety compliance, and issues pertinent certifications.

1 General Information



Abb.	Term	Description	Explanation
DC	Direct Current		
DetCon	Detonation Control System		Serves to prevent major engine damage that can be caused by knocking combustion.
EMI	Electromagnetic Interference		
EMC	Electromagnetic Compatibility		Compatibility of electrical or electronic equipment items with their surroundings
GPI	General Purpose Input	Multi-purpose input	
GPO	General Purpose Output	Multi-purpose output	
HV	High Voltage		
ISO	International Organization for Standardization		
LED	Light Emitting Diode		Light emitting electronic semiconductor
MIC	MOTORTECH Ignition Controller		
MICT	MOTORTECH Integrated Configuration Tool		Software for the configuration of the MIC3+
MOSFET	Metal Oxide Semiconductor Field-Effect Transistor		Semiconductor component
PG	Panzergewinde	Panzer screw thread	Screw thread type for cable screw connections
POT	Potentiometer		Continuously adjustable potential divider
PWR	Power	Output/current	
RET	Retard	Retarded with respect to the top dead center	Indicates the direction for timing

1 General Information

Abb.	Term	Description	Explanation
RS485/ TIA485	Recommended Standard 485/ Telecommunications Industry Association 485		Industrial standard for a physical interface for asynchronous serial data transfer
TDC	Top Dead Center		
USB	Universal Serial Bus		Serial connection system to link a computer to external devices

2 Safety Instructions



2.1 General Safety Instructions

The following safety instructions must be followed in the area in which the device is operated:



High voltage! Danger to life!

While the engine is running, there is danger to life through high voltage particularly in the area of the ignition system. The following parts should therefore not be touched or removed unless explicitly stated otherwise:

- Ignition coils and caps
- Wires of the high voltage circuit
- In- and output wiring of the ignition controller
- Pickups and their wiring



Danger to persons with pacemakers!

Electromagnetic impulses in the wiring of the ignition system may exceed the permissible limits of pacemakers. Persons with pacemakers must therefore not be present in the vicinity of the ignition system being operated. Mark the operating location of the ignition system with the corresponding standardized warning symbol.

MOTORTECH equipment is manufactured as state of the art and therefore safe and reliable to operate. Nevertheless the equipment can cause risks or damage can occur, if the following instructions are not complied with:

- The gas engine must only be operated by trained and authorized personnel.
- Observe all safety instructions of the system and all safety instructions of the system operator.
- Operate the equipment only within the parameters specified in the technical data.
- Use the equipment correctly and for its intended use only.
- Never apply force.
- For all work such as installation, conversion, adaptation, maintenance, and repair, all equipment must be disconnected from the mains and secured against unintentional reactivation.
- Perform only such maintenance and repair work as is described in this operating manual, and follow the instructions given while working.
- Only use spare parts supplied by MOTORTECH for the maintenance of the device.
- Further work must only be performed by personnel authorized by MOTORTECH. Non-compliance with the instructions will void any warranties for the proper function of the equipment as well as the responsibility for the validity of the certifications.

2 Safety Instructions

- Safety devices must not be dismantled or disabled.
- Avoid all activities that can impair the function of the equipment.
- Operate the equipment only while it is in proper condition.
- Investigate all changes detected while operating the gas engine or ignition system.
- Ensure compliance with all laws, directives, and regulations applicable to the operation of your system, including such not expressly stated herein.
- If the system is not entirely tight and sealed, gas may escape and result in explosion hazard. The inhalation of gas can also lead to death or severe health damages. Therefore, upon completion of all assembly works, always check the system's tightness.
- Always ensure adequate ventilation of the engine compartment.
- Ensure a safe position at the gas engine.
- There is a risk of burning on hot surfaces. Allow the gas engine to cool down before starting any work.
- Personal protective equipment (PPE), e.g. safety shoes and gloves, must be worn during all work on the gas engine.
- Noise from the system can cause permanent or temporary damage to your hearing. Wear suitable hearing protection at the system.
- Your behavior can reduce possible residual risks to a minimum. Observe responsible handling of the gas engine and the gas-carrying system.

2.2 Electrostatic Discharge Hazards

Electronic equipment is sensitive to static electricity. To protect these components from damage caused by static electricity, special precautions must be taken to minimize or prevent electrostatic discharge.

Observe these safety precautions while you work with the equipment or in its vicinity.

- Before performing maintenance or repair work, ensure that the static electricity inherent to your body is discharged.
- Do not wear clothing made from synthetic materials to prevent static electricity from building up. Your clothing should therefore be made of cotton or cotton mix materials.
- Keep plastics such as vinyl and Styrofoam materials as far away from the equipment as possible.
- Do not remove the circuit boards from the housing of the device.

2 Safety Instructions

2.3 Information on Electric Isolation

If ground and earth potential are not properly isolated, the following problems as well as others can occur:

- Electromagnetic interferences (e.g. ground loops)
- Signal corruption (e.g. of the analog voltage signal)
- Unwanted leakage currents

Therefore, earth potential and the negative pole of the power supply of all devices in the electric assembly that provide the option, should be connected separately. If possible, the negative pole of the power supply should only be connected to earth potential at one point in the entire system.

Wiring Example

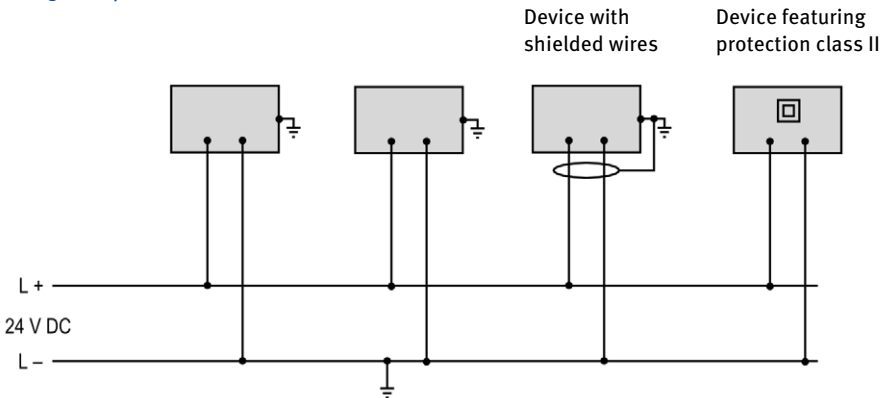

2 Safety Instructions



Occurrence of ground loops

The devices shown in the following image do not feature the possibility to connect the earth potential and the negative pole of the power supply separated from each other. How ground loops are created.

A ground loop is a ground connection of an electric wiring assembly that is closed as a loop. Due to impedance (resistance $R > 0$) of the loop, low-frequency interference currents can lead to an unwanted voltage drop in the signal path.

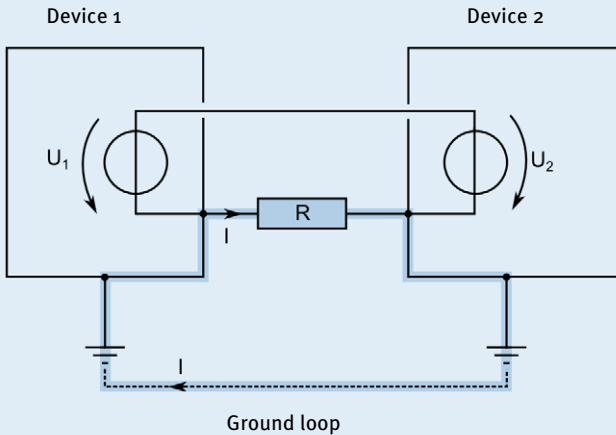

2.4 Special Safety Instructions for the Device



Danger to life! Hazardous residual voltage!

After stopping the ignition, there is dangerous residual voltage for up to three minutes in the ignition system. Do not touch any components of the ignition kit during this time.



Explosion hazard!

If the system is located in a hazardous area, never open the device (e.g. by opening the service screw or removing covers). There is a risk of explosion.



Explosion hazard!

The replacement of parts or assemblies can impair compliance with CSA Class I, Division 2 (Group C, D), T4.



Explosion hazard!

Do not disconnect any connectors while the system is live. If the system is located in a hazardous area, there is a risk of explosion.



Explosion hazard!

Never remove the equipment while the unit is connected to a power source. If the system is located in a hazardous area, there is a risk of explosion.



Explosion hazard!

Do not remove or replace the fuse while the equipment is live.

2 Safety Instructions



Risk of burning!

The surfaces of the system may heat up to high temperatures.



Operational safety!

All connector screws and screw joints must be adequately tightened.



Operational safety!

The proper functioning of the device is only guaranteed if the device is operated within the permissible supply voltage range. Therefore, use a power supply in accordance with the specifications in the operating manual.



Risk of destruction!

Magnetic fields and heat occur when welding, which may damage or destroy the MIC₃₊. Therefore, pay attention to the following when welding:

- Disconnect all electrical connections to the MIC₃₊ prior to welding.
- Protect the MIC₃₊ against direct contact with the welding unit and magnetic fields, sparks and liquid metal.

2.5 Proper Disposal

After the expiration of its service life, MOTORTECH equipment can be disposed of with other commercial waste, or it may be returned to MOTORTECH. We will ensure its environmentally friendly disposal.

3 Intended Use



3.1 Functional Description

The devices of the MIC3+ series are microprocessor controlled ignition systems, each consisting of a board with a 32 bit main processor (CPU).

Please note that the manufacturer is not required to implement configurations of the ignition controller for specific engines, and that devices may be delivered without pertinent configuration.

The ignition controllers of the MIC3+ series use information supplied by the pickups to precisely determine the correct timing for the respective outputs. The ignition timing is influenced by various inputs. This can be implemented using analog input signals, a speed characteristic, or using a serial interface (USB, CAN bus, RS485). The devices can also be equipped with an optional potentiometer for ignition timing adjustment.

During operation, the ignition controllers continuously monitor the system status of all installed pickups and the correct operation of the primary ignition circuit by checking the information received.

Depending on the severity of an error that is detected, the device will shut down immediately or warn the operator. A corresponding message can be viewed on a connected computer.

To protect the engine, the ignition controllers additionally have an adjustable overspeed shut-off.

3.2 Applications

The ignition controllers of the MIC3+ series are designed for specific 2- or 4-stroke gas engines. From 1 to max. 12 ignition outputs are available. The ignition controllers supply the energy required for the corresponding ignition coils of the gas engines and can supply signals for peripheral equipment.

Any use other than the one described in the operating manual shall be considered improper use and will result in the voiding of all warranties.

4 Product Description

4.1 Technical Data

4.1.1 Certifications

The ignition controllers of the MIC3+ series are certified as per the following directives/regulations:

CE

- EMC Directive 2014/30/EU
 - EN 61326-1:2013 – Electrical equipment for measurement, control and laboratory use. EMC requirements. General requirements
 - EN 55011:2009 + A1:2010 – Industrial, scientific and medical equipment. Radio-frequency disturbance characteristics. Limits and methods of measurement
 - EN 61000-6-2:2005 + AC:2005 – Electromagnetic compatibility (EMC). Generic standards. Immunity for industrial environments
 - EN 61000-6-4:2007 + A1:2011 – Electromagnetic compatibility (EMC). Generic standards. Emission standard for industrial environments
- Low Voltage Directive 2014/35/EU
 - EN 61010-1:2010 – Safety requirements for electrical equipment for measurement, control, and laboratory use. General requirements
 - EN 60529:1991 + A1:2000 + A2:2013 – Degrees of protection provided by enclosures (IP Code)
- RoHS Directive 2011/65/EU

CSA

- CSA Std C22.2 No. 0-10
- CSA Std C22.2 No. 142-M1987 (R 2004)
- CSA Std C22.2 No. 213-M1987 (R 2004)
- ANSI/ISA 12.12.01, Ed. 1 (2007)
- UL Std No. 916, Ed. 3 (1998)

4 Product Description



4.1.2 Mechanical Data

The MIC3+ has the following mechanical characteristics.

Feature	Value
Dimensions	Light Duty Version: 251 mm x 240 mm x 90.99 mm (9.90" x 9.45" x 3.58") (length x width x height) Heavy Duty Version: 251 mm x 240 mm x 107.5 mm (9.90" x 9.45" x 4.23") (length x width x height)
Weight	Light Duty Version: 3.1 kg (6.8 lbs) Heavy Duty Version: 3.8 kg (8.4 lbs)
Shape of device	See chapter <i>Overview Drawings</i> on page 26
Mechanical environmental conditions	The housing is resistant to general atmospheric contaminations. Resistant to gas engine lubricants. Protection class: I Protection: IP69 The specified protection class and type is only guaranteed if all external cable connections are connected according to the connector specification and the protective cap is firmly attached to the USB connection.
Climatic environmental conditions	Housing surface temperature: Light Duty Version: -40 °C to +60 °C (-40 °F to +140 °F) Heavy Duty Version: -40 °C to +70 °C (-40 °F to +158 °F) Max. 85 % humidity without condensation up to 3,000 m (9,842') above sea level

4 Product Description

4.1.3 Warning Notices on the Device



Validity of warning notices on device

The warning notices on the device are valid for the MIC₃₊ and all components connected to it.

Warning notice on the device	German translation	French translation
WARNING! Read and understand the installation and operating manual prior to installing or making any adjustments.	WARNUNG! Lesen und verstehen Sie die Installations- und Betriebsanleitung vor der Installation und bevor Einstellungen vorgenommen werden.	ATTENTION! Lisez et comprenez le manuel d'installation et d'utilisation avant d'installer ou d'effectuer une modification.
EXPLOSION HAZARD! Do not disconnect while circuit is live unless area is known to be non-hazardous. For wiring details refer to the operating manual.	EXPLOSIONSGEFAHR! Keine Verbindungen lösen, solange der Stromkreis aktiv ist, außer das Umfeld wird als nicht explosionsgefährdet eingestuft. Hinweise zur Verkabelung finden Sie in der Betriebsanleitung.	AVERTISSEMENT - RISQUE D'EXPLOSION! Ne pas débrancher tant que le circuit est sous tension, à moins qu'il ne s'agisse d'un emplacement non dangereux. Pour plus de détails de câblage, veuillez consulter le manuel d'utilisation.
CAUTION! Do not pressure wash this device. Damage to electronic components may result.	ACHTUNG! Das Gerät nicht mit Hochdruck reinigen. Es könnte zu Schäden an den elektronischen Bauteilen führen.	ATTENTION! Ne pas laver cette boîte de contrôle en utilisant un jet sous pression. Cela pourrait endommager les composants électroniques.

Warning Symbol on Device



Warning of hot surface

4 Product Description



4.1.4 Product Identification – Labeling on the Device

The necessary numbers for unique product identification are on the device:

- Part number of the ignition controller (P/N)
- Arrangement number of the ignition controller (A/N)
- Serial number of the ignition controller (S/N)



www.motortech.de



P/N	66.00.350-12
A/N	3C1.12.C0Q0-000-AA-3
S/N	012345678

4.1.5 Electrical Data

The MIC3+ has the following electrical characteristics.

Feature	Value
Power consumption	Max. 65 W at 24 V
Power supply	Nominal voltage: 24 V DC Operating voltage: 10 V DC to 32 V DC
Required current	Max. current 7.0 A. An estimation of the power requirements can be found after this table.
Number of outputs	6 or 12 outputs
Firing angle	The size of the firing angle depends on the max. overspeed. The smallest ignition angle can be calculated using the following formula: $\text{Ignition Angle} = \frac{\text{Overspeed} [\text{min}^{-1}]}{60} \times 360^\circ \times 1.7 \text{ ms}$

4 Product Description

Feature	Value
Ignition frequency	<p>With full energy output (all 12 ignition outputs with 300 mJ), an ignition frequency of 180 Hz as continuous load is possible. With less ignition energy or in case of a brief overload, 200 Hz is possible. The maximum output load of 60 W must not be exceeded.</p> <p>2-stroke engine:</p> $\text{Ignition Frequency} = \frac{\text{Overspeed} [\text{min}^{-1}]}{60} \times \text{Number of Ignition Outputs}$ <p>4-stroke engine:</p> $\text{Ignition Frequency} = \frac{1}{2} \times \frac{\text{Overspeed} [\text{min}^{-1}]}{60} \times \text{Number of Ignition Outputs}$

Estimation of Current Requirements

These current values are based on a nominal speed of 1800 rpm and 300 mJ energy.

Outputs	Voltage	Required current	Voltage	Required current
6	24 V	2.1 A	12 V *	3.9 A
12	24 V	3.3 A	12 V *	6.4 A

* Nominal voltage 24 V DC

Electrical Data for Inputs and Outputs

The inputs and outputs of the ignition controller have the following electrical data:

Inputs and outputs	Values
Analog current input	Current range: 0 mA to 20 mA (adjustable in MICT) Input impedance: 27 Ω 1 μF
Analog voltage input	Voltage range: 0 mA to 10 mA (adjustable in MICT) Input impedance: 12.4 kΩ 200 nF
Auxiliary analog input supply voltage	5 V to 24 V/50 mA depending on the configuration in the MICT

4 Product Description



Inputs and outputs	Values
Binary input (Start/Stop)	<p>Wiring</p> <p>Input current: max. 20 mA Ignition stop: 0 V to 0.8 V (low level) Ignition release: 2.8 V to 32 V (high level)</p>
Binary input (schedule A/B)	<p>Wiring</p> <p>Input current: max. 20 mA Schedule A: 0 V to 0.8 V (low level) Schedule B: 2.8 V to 32 V (high level)</p>
Binary input (GPI, general purpose input)	<p>Wiring</p> <p>Input current: max. 20 mA Low level: 0 V to 0.8 V High level: 2.8 V to 32 V</p> <p>(Function dependent on the configuration in MICT, see <i>Inputs/Outputs – Inputs</i> on page 105)</p>
Go/NoGo and GPO outputs	<p>One GPO (General Purpose Output) and one Go/NoGo output</p> <p>Implementation as optical MOSFET relay</p> <p>Maximum switching voltage: 32 V DC</p> <p>Peak/steady current: max. 100 mA DC</p> <p>Output power: max. 2.5 W</p> <p>Internal resistance: 58 Ω to 60 Ω</p> <p>Activation delay: 0.5 ms / max. 100 mA load</p> <p>Deactivation delay: 0.2 ms / max. 100 mA load</p> <p>If a short is found at the output, a safety circuit, which makes the output highly resistive, is found at the output, so that the current sets itself at 50 mA to 60 mA.</p>
LED	Five LEDs are used as status indicators.
ASO output	<p>TTL level (5 V)</p> <p>max. current: \pm 10 mA</p>

4 Product Description

Inputs and outputs	Values
Pickup input	<p>Impedance: 10 kΩ</p> <p>The voltage supply for inductive pickups can be set using the MICT from 5 V to 24 V.</p> <p>Max. frequency for the pickups: 10 kHz</p> <p>The formula for determining the frequency of the pickups can be found in the note following this table.</p> <p>For a pickup output impedance of 120 Ω to 10 kΩ, the pickups connected to the MIC3+ may not have a higher voltage than ± 40 V and the connected power may not exceed 1 W.</p>
Ignition coil outputs	<p>Output voltage: max. 250 V</p> <p>Output energy in normal operation: max. 300 mJ (depending on the ignition coils used)</p> <p>Output energy in the start phase: max. 500 mJ</p>



Frequency of the pickups

The frequency of the pickup is calculated as per the following formula.

$$\text{Frequency} = \frac{\text{Overspeed} [\text{min}^{-1}]}{60} \times \text{Number of Pickup Events per Revolution}$$

4 Product Description



4.1.6 Interfaces

Depending on the device version, the following interfaces are available:

USB Interface

- Compatible with USB 1.1 and higher
- The connector type B is only suitable for temporary data exchange and not for a permanent connection.
- Max. wire length 5 m (16.4')

CAN Bus Interface

- Classical Extended Frame Format (CAN 2.0B)
- As per ISO 11898 standard, 50 kbit/s to 1 Mbit/s
- Protected against transients (automotive classification)
- Max. 110 participants
- Max. wire length 250 m (820') depending on the transfer rate

RS485 Interface

- According to TIA-485-A (03/2003)
- Max. 32 participants
- Max. data transfer rate 9.6 kbit/s to 115.2 kbit/s
- Max. wire length 100 m (328') depending on the transfer rate



Pay attention to the wiring diagrams

Depending on the device version, certain signals or interfaces described in these instructions may not be available. You are also always to pay attention to the wiring diagrams enclosed with the input and output cable harnesses.

4.1.7 Requirements for External Equipment

External equipment shall fulfill the input and output specifications of the MIC₃₊.

4 Product Description

4.1.8 Overview Drawings

The connectors shown correspond to the standard version.

Plan View

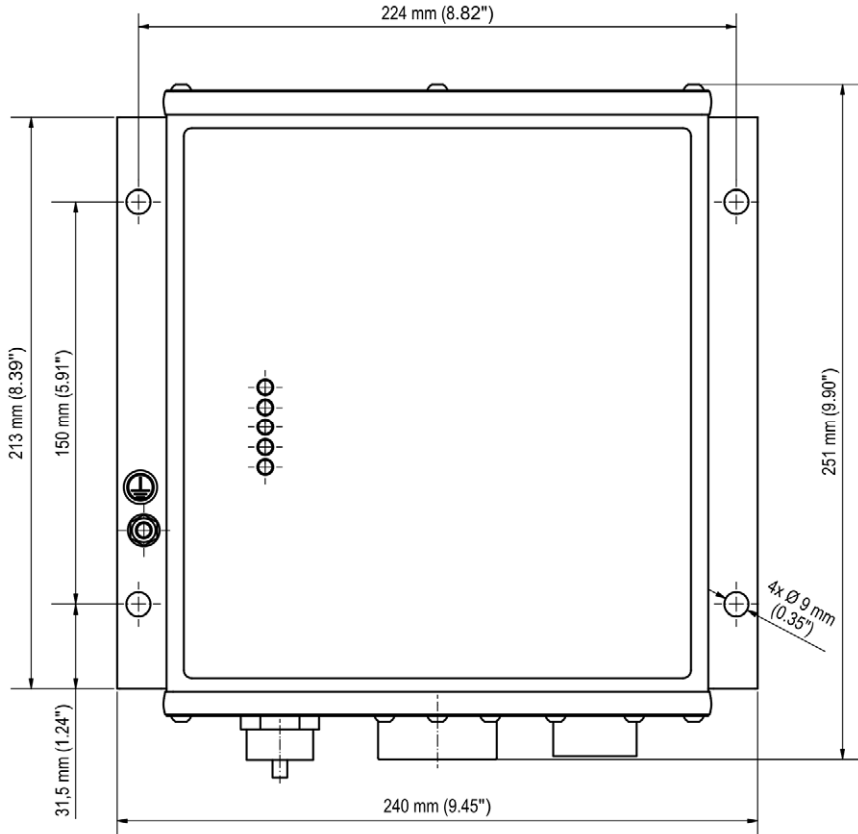

4 Product Description

Front View Light Duty Version

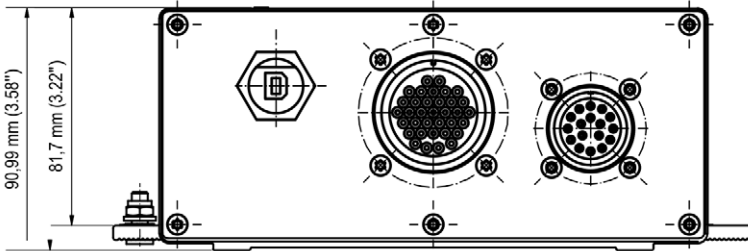

Front View Heavy Duty Version

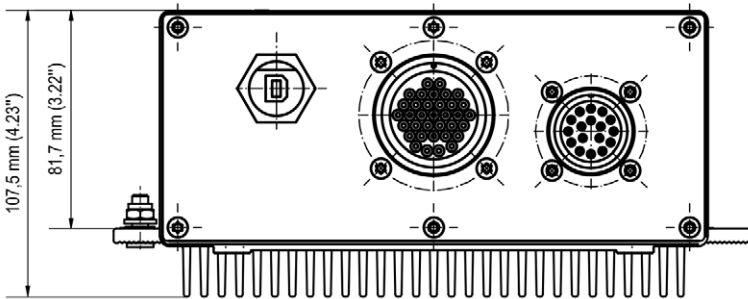

USB Connection

A USB connection is located at the front of the device to connect the MIC₃₊ to a computer.

4 Product Description

4.1.9 LED Functions

- Status
- Firing
- Pickup 1
- Pickup 2
- GPO

Labeling	Function
Status	<p>Up to firmware version 1.11.00000:</p> <p>LED flashes green if the device is running with no errors. The LED flashes red if an error has occurred. The LED flashes yellow if a warning has occurred.</p> <p>As of firmware version 1.11.00000:</p> <p>LED flashes green if the device is running with no errors. The LED flashes red if an error has occurred. For details, refer to the following overview.</p> <p>The firmware version of your device can be found in the MICT in the window <i>Runtime Data – Information</i>. Refer to the section <i>Runtime Data – Information</i> on page 136.</p>
Firing	LED lights up when the ignition is active (exception: during the self test).
Pickup 1 and 2	LEDs flash when the pickups are active.
GPO	LED is on when the GPO is activated.

Indication via the Status LED (from firmware version 1.11.00000)

The flashing sequences shown below are repeated until the device has left the respective state again. However, the flashing sequences are always executed to the end and are not interrupted accordingly.

The status LED flashes green:

- **Waiting for sufficient supply voltage**

Fast flashing green/off 100 ms



- **Synchronization/ Firing active**

Flashing one time green 250 ms on, 750 ms off



4 Product Description



- **Ready for operation**

slow flashing green/off 500 ms



- **Bootloader – connection to computer started/ update mode**

Flashing one time green 2,000 ms on, 250 ms off



- **Firing locked**

3 flashes green/off 250 ms, 750 ms off



- **Configuration/ Wait for 0 RPM**

6 flashes green/off 250 ms, 750 ms off



The status LED flashes red:

- **Critical error/ Assertion**

fast flashing red/off 100 ms



- **Operating error – general/ System error**

slow flashing red/off 500 ms



- **Bootloader – faulty firmware**

Flashing one time red 2,000 ms on, 250 ms off



- **Operational error – pickup**

2 flashes red/off 250 ms, 750 ms off



4 Product Description

- **Operational error – overspeed**

4 flashes red/off 250 ms, 750 ms off



- **Operational error – insufficient supply voltage**

5 flashes red/off 250 ms, 750 ms off



The status LED flashes orange:

- **Selftest**

Flashing one time orange 250 ms on, 750 ms off



5 Installation Instructions



5.1 Unpacking

Unpack the equipment, taking care not to damage it. Always place the device safely and protected from falling over or falling down. Ensure that the operating manual is always stored with the ignition controller and is easily accessible. Check the contents for completeness and verify that the device type meets your application requirements.

Scope of Supply

The scope of supply of the MIC3+ ignition controller consists of the following components:

- Ignition controller of the MIC3+ series
- Installation set incl. four vibration dampers
- Ground strap
- Three multiple sealing inserts and five sealing plugs for PG screw joints
- Storage device (USB flash drive or CD-ROM) with software for configuring the ignition controller
- USB interface cable for connecting the ignition controller to a computer
- Operating manual

5.2 Installation of the Ignition Controller

The installation of the MIC3+ ignition controller is implemented on a fixed bracket e. g. on a wall near the engine. Use the included rubber vibration dampers and the ground strap. The installation location of the controller must be selected so that the distance to the pickups installed on the engine ensures a reliable signal transmission to the ignition controller, and so that there is adequate space for maintenance and repair work. The mechanical specifications must always be complied with (refer to *Mechanical Data* on page 19). The ground strap serves to ground the ignition controller and must be used accordingly. Ensure a flawless electrical connection for this purpose.

Installation locations where strong vibrations or extreme ambient temperatures are present are not permissible and result in the warranty being voided. The permissible temperature range is:

-40 °C (-40 °F) to +60 °C (+140 °F)



Risk of destruction!

The device must not be installed directly on or at the engine, as vibration and heat may cause damage to electronic components. This also applies if vibration dampers are used.

5 Installation Instructions

5.2.1 Installation of the Vibration Dampers

There are two options for using the vibration dampers from the MIC3+'s scope of supply. The hole patterns can be found in section *Overview Drawings* on page 26.

Option A

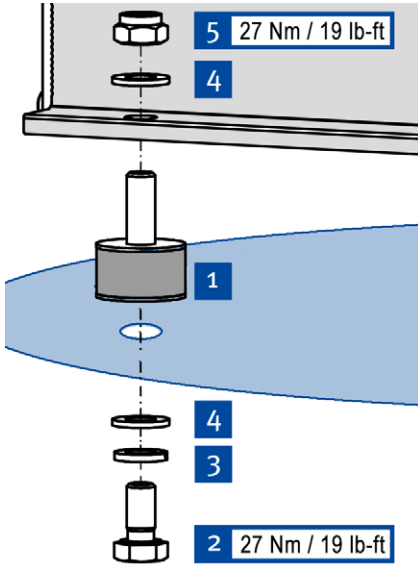

1. Fasten the four vibration dampers **1** to the selected installation location. Use four screws M8x16 **2**, four rim lock washers M8 **3** and four washers M8 **4**.
2. Fasten the MIC3+ to the vibration dampers. Use four washers M8 **4** and four lock nuts M8 **5**.
 - ▶ Fasten the ground strap to the ground pin (see *Installation of the Ground Strap* on page 33).

5 Installation Instructions

Option B

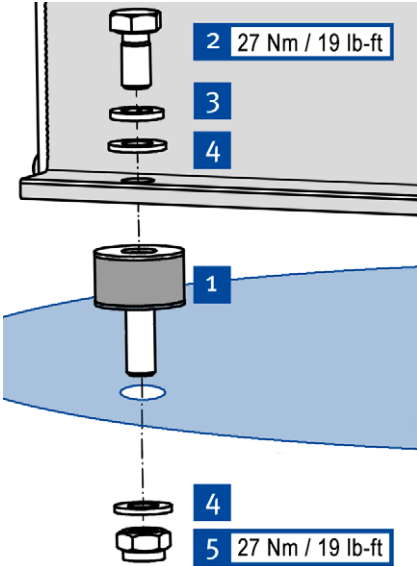

1. Fasten the four vibration dampers **1** to the MIC₃+. Use four screws M8x16 **2**, four rim lock washers M8 **3** and four washers M8 **4**.
2. Fasten the MIC₃+ to the selected installation location using the vibration dampers. Use four washers M8 **4** and four lock nuts M8 **5**.
 - Fasten the ground strap to the ground pin (see *Installation of the Ground Strap* on page 33).

5.2.2 Installation of the Ground Strap

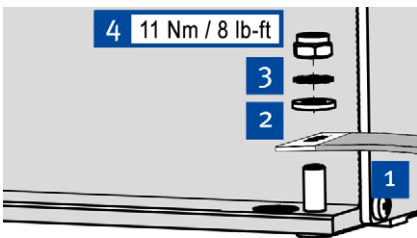

1. Fasten the ground strap **1** to the MIC₃+ ground pin. To do so, use one washer M6 **2**, one tooth lock washer A6 **3** and one poly lock nut M6 **4**.
2. Connect the ground strap to one of the sides suitable for grounding.
 - You can wire the ignition controller as described in section *Wiring of the Device* on page 35.

(schematic representation)

■ 5 Installation Instructions

5.3 Determine the Installation Location of the Pickup

Set the positions of the pickups depending on engine type and application. All angle reference information is based on:

TDC 1st cylinder / compression cycle

The installation location for the pickups must have adequate mechanical strength and must not exceed the specified temperature ranges. The pickups are designed for the appropriate use only, multiple use of the pickup signal is not permissible. Ensure good accessibility to facilitate the calibration of the sensor. Comply with the pertinent regulations for the wire routing.

For the exact positioning of the individual pickups, refer to the examples given in the drawings (see section *Input Wiring – Pickups* on page 39).

6 Wiring of the Device

6.1 Input and Output Wiring on the Controller



Operational safety!

All connector screws and screw joints must be adequately tightened.



Assignment of the wire colors

Take the assignment of the wire colors of the wiring harness for the input and output wiring from the wiring diagram enclosed with the wiring harness.



Pay attention to the wiring diagrams

Depending on the device version, certain signals or interfaces described in these instructions may not be available. You are also always to pay attention to the wiring diagrams enclosed with the input and output cable harnesses.

6 Wiring of the Device

6.1.1 Input Wiring

Input Connector

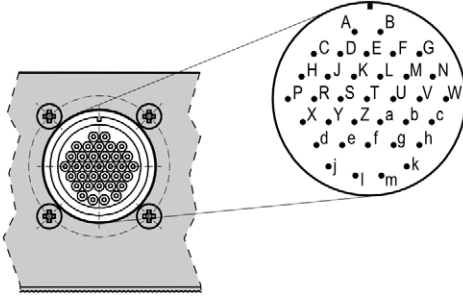

35-pole input connector (outside view)

Pin	Assignment	Pin	Assignment
A	L + (24 V)	V	ASO +
B	L – (negative pole)	W	ASO –
C	Pickup 1	X	ASO Shield
D		Power	Y
E		Z	TX –
F		a	Com
G	Pickup 2	b	RX +
H		Power	c
J		d	Analog GND
K		e	Analog Power
L	CAN	f	Timing I in –
M		Hi	g
N		h	Analog Shield
P		j	Start/Stop +
R	Go/NoGo +	k	Schedule A/B +
S	Go/NoGo –	l	GPI1 +
T	GPO +	m	Binary Com
U	GPO –		

6.1.2 Input Wiring – Power Supply



Operational safety!

The proper functioning of the device is only guaranteed if the device is operated within the permissible supply voltage range. Therefore, use a power supply in accordance with the specifications in the operating manual.



Design of power supply

For the power supply, an overcurrent protection mechanism must be set up with a circuit breaker (16 A DC with tripping characteristic B), which allows switching off. When selecting the circuit breaker, the conditions of the installation site and the ambient temperature must be considered. The circuit breaker must be easy for the user to access and marked as a disconnecting device for the ignition controller.

If the power is supplied via a power supply unit, the following specifications must be observed additionally:

- Voltage: 24 V DC; Current: at least 25 A
- Wiring: at least 1.5 mm² cross-section

6 Wiring of the Device

L \triangleq 24 V DC (nominal voltage)

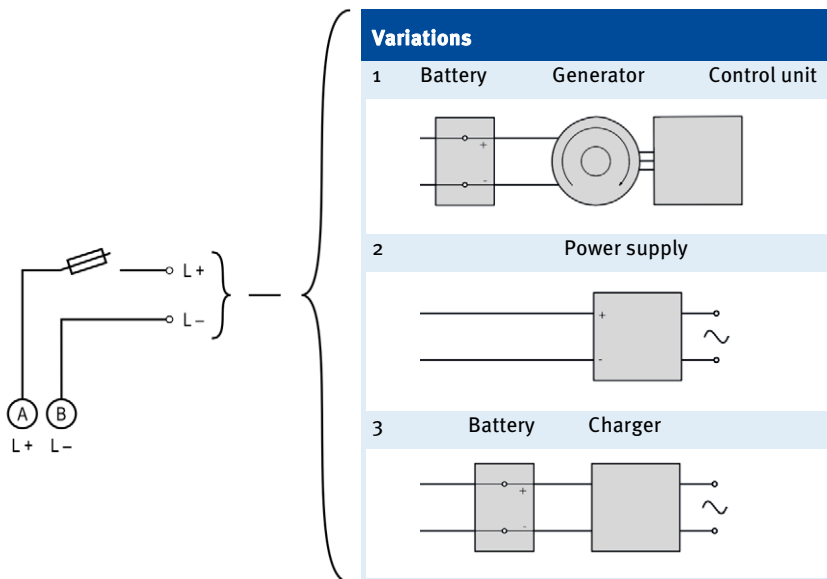

6 Wiring of the Device



6.1.3 Input Wiring – Pickups

Example Configuration (one Active, one Passive Pickup)

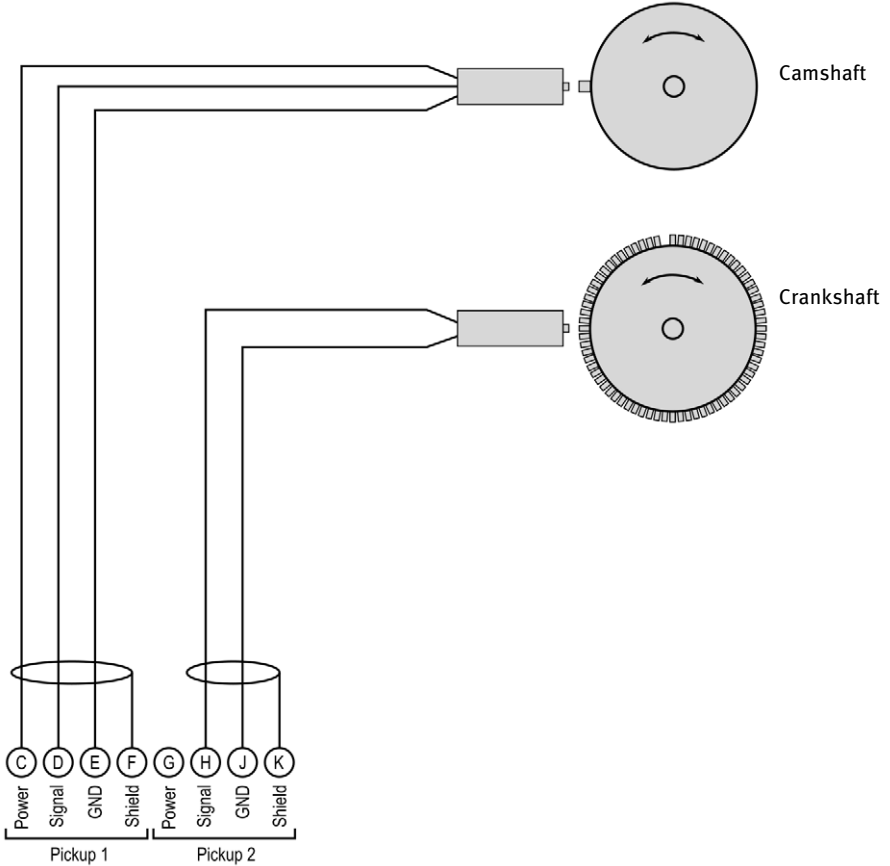

The recommended distance to the triggering is 0.75 mm to 1 mm (0.03" to 0.04") for MOTORTECH pickups. Please note that additional fine-tuning is required for every pickup position due to the different conditions of the engines.

6 Wiring of the Device

One revolution of the pickup changes the distance as follows:

Thread	Change in distance
M12x1	1 revolution \triangleq 1 mm (0.04")
5/8"-18 UNF	1 revolution \triangleq 1.41 mm (0.05")
3/4"-16 UNF	1 revolution \triangleq 1.59 mm (0.06")

Allocation of the Wire Colors (Example Configuration)

Camshaft

PIN	Designation	Wire color
C	Pickup 1 Power	Brown
D	Pickup 1 Signal	black
E	Pickup 1 GND	blue
F	Pickup 1 Shield	Shield

Crankshaft

PIN	Designation	Wire color
H	Pickup 2 Signal	White
J	Pickup 2 GND	Brown
K	Pickup 2 Shield	Shield

For problems with the pickup signals, refer to the section *Pickup Input Errors* on page 158.



Adjusting the pickup sensitivity

Depending on the type of impulse source (interference), it may be necessary to increase the pickup sensitivity to ensure that the resultant signal strength is sufficient for reliable operation. You can make these adjustments in the MICT. Refer to the section *Engine – Pickups* on page 91.

6 Wiring of the Device



Aux. pickup supply voltage

An auxiliary supply voltage for active pickups can be configured using the MICT. The voltage can be set in the range from 5 V to 24 V and is supplied at the connections *Pickup 1 Power* to *Pickup 2 Power*. Refer to the section *Engine – Pickups* on page 91.

6.1.4 Input Wiring – Timing and Safety Devices

Example Configuration

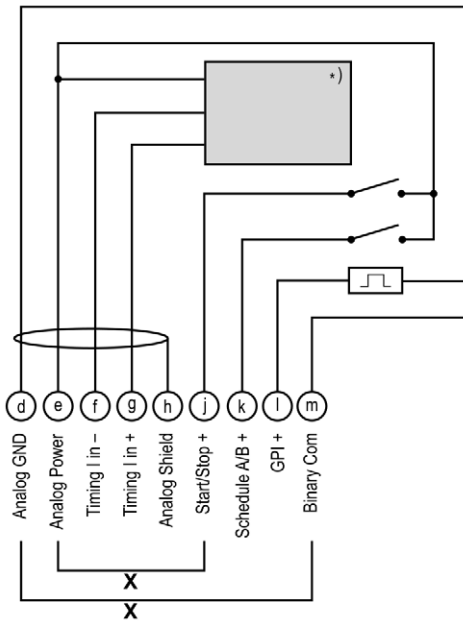

*) See subsequent drawings for details

x = bridge for permanent authorization

Switch Start/Stop

open	Ignition – OFF
closed	Ignition – ON

Switch A/B

open	Schedule A
closed	Schedule B

6 Wiring of the Device

Two-Wire Transmitter

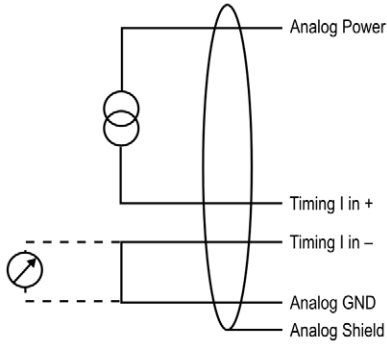

Four-Wire Transmitter

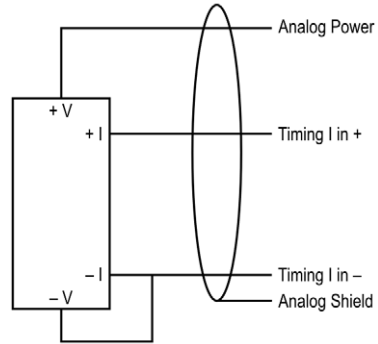

Auxiliary analog input supply voltage

An auxiliary supply voltage for the analog inputs can be configured using the MICT. The voltage can be set in the range of 5 to 24 V and is made available on the connection *Analog Power*. Refer to the section *Timing – Analog Inputs* on page 95.



Wiring MIC3+ ignition controller and DetCon detonation control system

The following diagram shows an example of the wiring of a MIC3+ ignition controller with a DetCon detonation control system in cases where the analog current signal ($4\text{-}20\text{ mA}$) at the output *I out* is to be used for the ignition timing adjustment.

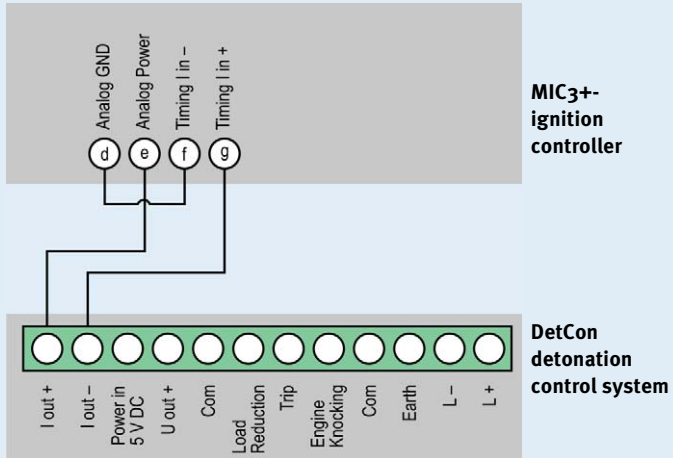

Furthermore, the limits of the analog current input will need to be set at 4 mA to 20 mA and the auxiliary supply voltage of the analog inputs to 24 V in the MICT. Refer to the section *Timing – Analog Inputs* on page 95.

The timing is transmitted by MIC3+ via the auxiliary synchronization output (ASO) to the DetCon, and will need to be wired and configured accordingly. Refer to the section *Output Wiring – Binary Outputs (Go/NoGo, GPO, ASO)* on page 44.



General purpose input GPI

The general purpose input GPI can be assigned various functions via the configuration. Refer to the section *Inputs/Outputs – Inputs* on page 105.

6 Wiring of the Device

6.1.5 Output Wiring – Binary Outputs (Go/NoGo, GPO, ASO)

Example Configuration

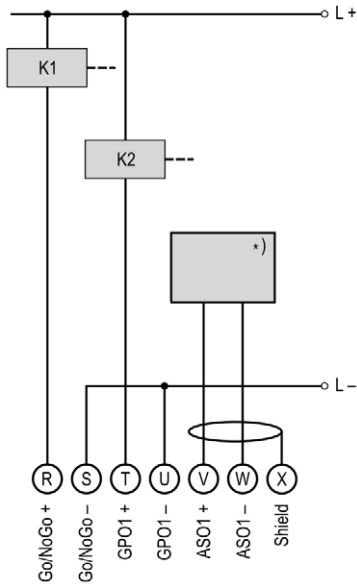

*) DetCon or other external device (for wiring of the DetCon, see following example)

K1 = Go/NoGo relay

K2 = GPO relay

$L \triangleq 7 \text{ V DC to } 32 \text{ V DC}$

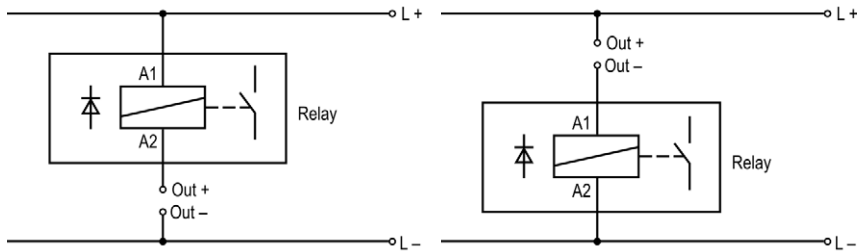

$(L \triangleq 7 \text{ V DC to } 32 \text{ V DC})$

6 Wiring of the Device



DetCon connection

Connect the ASO output on the DetCon to the connections *in A* and *in B* on connector *Synchronization*.

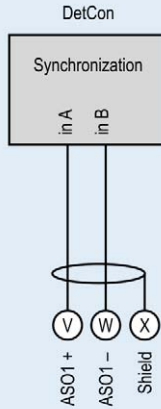

6.1.6 Wiring – PowerView₃

Connect the PowerView₃ visualization unit to the MIC₃+ as follows.

CAN Connection between Ignition Controller and PowerView₃

As shown in the following illustration, you can connect the PowerView₃ directly to the MOTORTECH ignition controller using the CAN cable delivered with the PowerView₃. To do so, you need to insert the connector in the CAN interface on the PowerView₃. On the ignition controller, connect the color-coded conductors of the CAN cable to the correct CAN interface connections.

6 Wiring of the Device

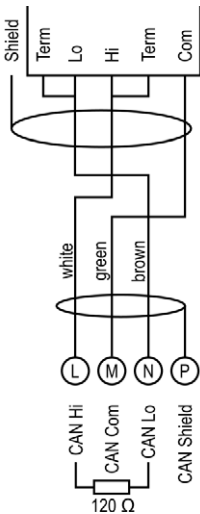

Connector for CAN interface on PowerView3

CAN interface on the ignition controller

PowerView3 Power Supply via the Ignition Controller

If you use a MOTORTECH ignition controller with a service cover and connector strip, you have the option of supplying power to the PowerView3 via the ignition controller. A special connector is included in the PowerView3's scope of supply. The connector for the voltage supply of the ignition controller must be replaced by this one.

Connector supplied with the ignition controller:

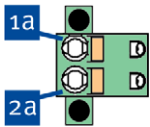

Connector supplied with PowerView3:

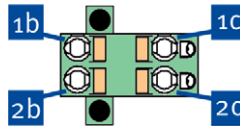

Proceed as follows:

1. Disconnect the power supply to the ignition controller and, if necessary, to the PowerView3.
2. Remove the connector for the power supply from the ignition controller.
3. Negative terminal: Disconnect the conductor from the contact **1a** and insert it into contact **1b** of the connector provided with the PowerView3.

6 Wiring of the Device



4. Positive terminal: Disconnect the conductor from the contact **2a** and insert it into contact **2b** of the connector provided with the PowerView3.
5. From the PowerView3 power supply cable, plug the L- wire (white) into contact **1c**. For plugging into the contact, use a wire end ferrule provided with the PowerView3.
6. From the PowerView3 power supply cable, plug the L+ wire (brown) into contact **2c**. For plugging into the contact, use a wire end ferrule provided with the PowerView3.
7. Insert the connector provided with the PowerView3 into the power supply connection of the ignition controller.
8. Insert the connector at the other end of the PowerView3 power supply cable into the PowerView3 power supply connection.
9. Connect the device's power supply.
 - ▶ The power supply of the PowerView3 is now provided through the connector on the ignition controller.

6.1.7 Output Wiring – CAN Bus Interface

The wiring of the ignition controller of the MIC₃+ series is carried out as standard via a MOTORTECH wiring harness. This contains a 120 Ω terminating resistor for the CAN bus. The devices must therefore be used at the bus end.

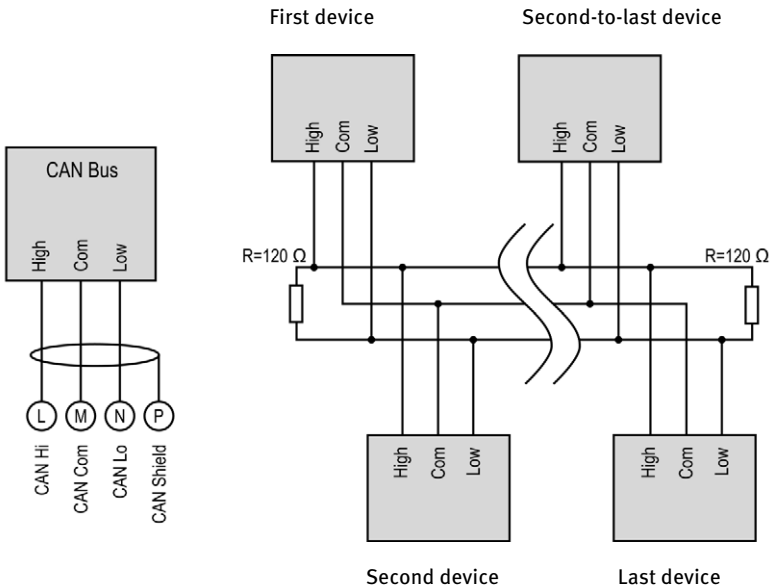

6 Wiring of the Device



CANopen® protocol

If you require information on the CANopen® protocol, contact your MOTORTECH contact person.



CAN bus wiring

Note the following when connecting the CAN bus:

- Each bus end must be fitted with a terminating resistor of 120 Ω (see drawing).
- The maximum wire length depends on the bit rate:

Bit rate	Maximum wire length	Maximum length of a stub	Maximum length of all stubs
1 Mbit/s	25 m (82')	1.5 m (5')	7.5 m (25')
800 kbit/s	50 m (164')	2.5 m (8')	12.5 m (41')
500 kbit/s	100 m (328')	5.5 m (18')	27.5 m (90')
250 kbit/s	250 m (820')	11 m (36')	55 m (180')
125 kbit/s	500 m (1,640')	22 m (72')	110 m (360')
50 kbit/s	1,000 m (3,280')	55 m (180')	275 m (902')

- Only use cables that are specified by the manufacturer for use in the CAN bus.

6 Wiring of the Device

6.1.8 Output Wiring – RS485 Interface

The RS485 interface can be wired as two-wire or four-wire wiring and twisted cables must be used. With both variants the load resistance ($R_T=120\ \Omega$) is the characteristic impedance of the cable.

Two-Wire Wiring

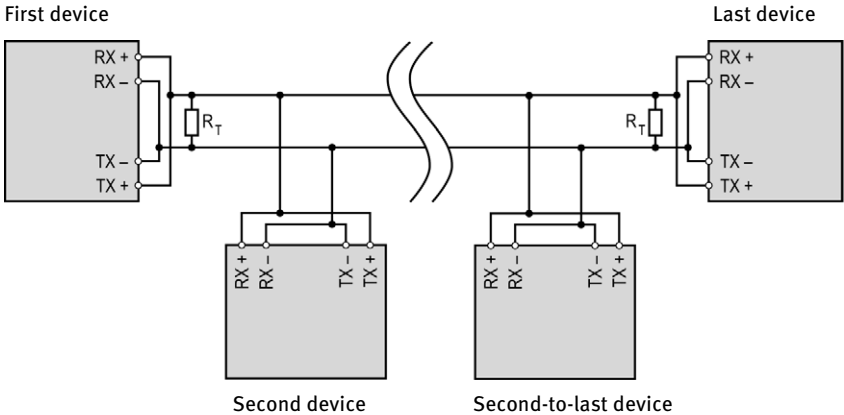

Four-Wire Wiring

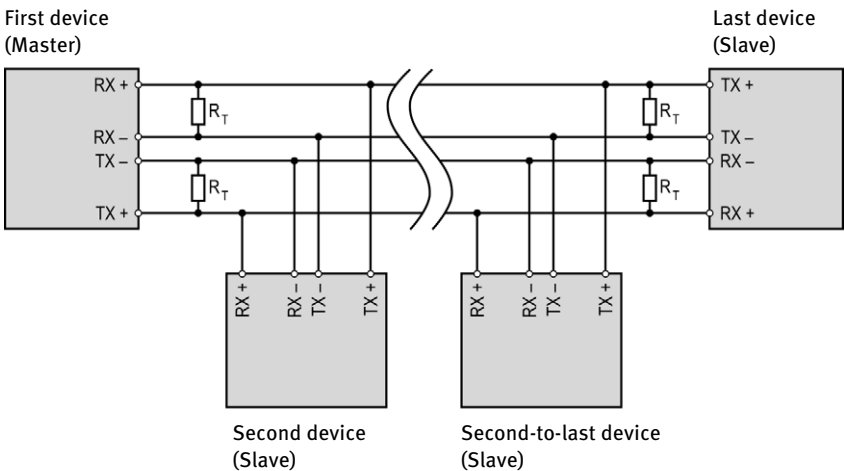

6 Wiring of the Device

Connection on the Ignition Controller

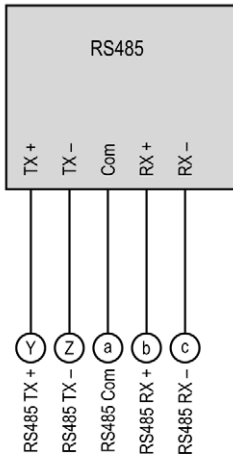

Wiring of the RS485 interface

Follow these instructions for the RS485 interface wiring:

- Max. 32 devices can be connected to a bus.
- The maximum wire length is 100 m (328') depending on the transfer rate.
- Each bus end must be fitted with a terminating resistor with 120 Ω in each pair of leads (as indicated in the drawing).

6.2 Ignition Coil Wiring



Protection when using wiring rails

Every wiring rail on the engine block should be grounded to avoid disruptions in the device caused by secondary current in the ignition coils.



Ignition coil wiring

In the MICT there are two types of wiring with predefined output configuration supported in the engine database for many engines:

- Wired in straight order
- Wired in firing order

For information on straight order wiring refer to *Straight Order Wiring of the Ignition Outputs* on page 52 and *Engine – Parameters* on page 83.

For wiring in firing order, the first cylinder in the firing order is connected to the A1 output, the second to A2, etc.

If a different wiring was implemented, the output configuration in the MICT must be adapted accordingly. Please note that the wiring cannot be checked by the software (see section *Engine – Parameters* on page 83).



Conductor cross-section for primary wiring

If you do not use a harness manufactured by MOTORTECH, the primary wiring must have a conductor cross-section of 1.5 mm².

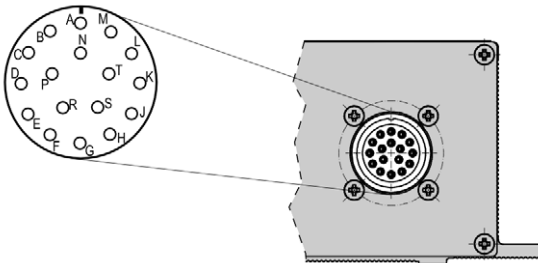

17-pole connector (outside view)

6 Wiring of the Device

The table shows the pole assignments for the standard 6 and 12 cylinders versions of the MIC3+.

Pole	12 outputs	6 outputs
A	Output A1	Output A1
B	Output A2	Output A2
C	Output A3	Output A3
D	Output A4	Output A4
E	Output A5	Output A5
F	Output A6	Output A6
G	Output A7	Not assigned
H	Output A8	Not assigned
J	Output A9	Not assigned
K	Output A10	Not assigned
L	Output A11	Not assigned
M	Output A12	Not assigned
N	Not assigned	Not assigned
P	Not assigned	Not assigned
R	Not assigned	Not assigned
S	Not assigned	Not assigned
T	Ground	Ground

6.3 Straight Order Wiring of the Ignition Outputs



Risk of damage to engine

If you use MOTORTECH wiring rails for straight order wiring, it is absolutely necessary that they are correctly selected and installed for the respective engine. Even a rotated installation can cause serious damage to the engine, for example.

Straight order wiring, along with wiring in firing order, is supported by the MICT for many engines with predefined output configurations in the engine database. That means that if the wiring is carried out accordingly and the option *Wired in Straight Order* is selected in the MICT, no other adaptation of the output configuration is necessary.

6 Wiring of the Device



You can use straight order wiring, if:

- Wiring takes place via a corresponding MOTORTECH wiring harness and a MOTORTECH wiring rail. The harness is marked with the following information: *PLEASE NOTE! The firing order needs to be configured directly in the ignition controller.* The ignition coils on the wiring rail are identified with *Connector Pin 1* to *Connector Pin X*.
- Make the wiring of the ignition controller corresponding to the instructions in the following sections (for example with an open wiring harness or via a junction box).

The execution of straight order wiring is dependent on the type of engine (in-line or V-engine).

Version with 6 Outputs

Pole	6 outputs	In-line engine		V-engine	
		Connector*	Coil**	Connector*	Coil**
A	Output A1	1	1	1	1
B	Output A2	1	2	2	1
C	Output A3	1	3	1	2
D	Output A4	1	4	2	2
E	Output A5	1	5	1	3
F	Output A6	1	6	2	3
G	–				
H	–				
J	–				
K	–				
L	–				
M	–				
N	–				
P	–				
R	–				
S	–				
T	Ground				

Connector* = connector on the wiring rail

Coil** = ignition coil with the corresponding number on the wiring rail

6 Wiring of the Device

Version with 12 Outputs

Pole	12 outputs	In-line engine		V-engine	
		Connector*	Coil**	Connector*	Coil**
A	Output A1	1	1	1	1
B	Output A2	1	2	2	1
C	Output A3	1	3	1	2
D	Output A4	1	4	2	2
E	Output A5	1	5	1	3
F	Output A6	1	6	2	3
G	Output A7	1	7	1	4
H	Output A8	1	8	2	4
J	Output A9	1	9	1	5
K	Output A10	1	10	2	5
L	Output A11	1	11	1	6
M	Output A12	1	12	2	6
N	–				
P	–				
R	–				
S	–				
T	Ground				

Connector* = connector on the wiring rail

Coil** = ignition coil with the corresponding number on the wiring rail

The ignition controllers of the MIC3+ series include freely configurable safety and auxiliary functions that, amongst others, can shut down the engine in case of fault.



Angle indications in the operating manual

All angles in this operating manual are given in °crankshaft. Exceptions are clearly identified.

7.1 Pickup Sensitivity

To increase the signal interference distance, the sensitivity of the pickup signal inputs can be changed for suitable pickup signals. This setting can be implemented individually for each input. For this purpose, a pre-trigger voltage can be set below which signals are interpreted as interference and are therefore not analyzed. A pre-trigger voltage set to a high level will thus result in a low pickup sensitivity level.

You can enter the settings for the pickup sensitivity with the MICT. Refer to the section *Engine – Pickups* on page 91.

7.2 Monitoring of Pickup Signals

The MIC3+ monitors the pickup signals. Any other errors are displayed in the MICT. For more information on the errors, please refer to the overview in the section entitled *Pickup Input Errors* on page 158.

7.3 Go/NoGo

The binary output (Go/NoGo) is a potential-free output. It is closed during firing and opens when the ignition switches off. The max. switching current is 100 mA. The output can drive an external relay that e.g. opens a gas valve.

The following errors can cause the ignition outputs to shut down:

- Overspeed
- Pickup error
- Error HV power supply
- Failure of the output monitoring
- Overload/temperature shut-down
- Alarms
- Insufficient supply voltage (Low Power)

7 Functions



Use master control

The outputs of the MIC₃₊ are not SIL compliant. Therefore, always use an additional master control for safety-critical applications.

7.4 Ignition Timing Adjustment

The ignition controller has several functions for the timing correction.



Influences on ignition timing

Be aware that the actual timing of the engine can also be influenced by external signals (e.g., analog current or voltage input).



Operational safety!

The MIC₃₊ ignition controller must first be correctly configured for the engine being used before you can start the engine.

An incorrect configuration can result in damage to the engine.

The figure below gives you an overview of the different functions of the timing correction, which will be explained in more detail in the subsequent sections. Functions that can be activated/disabled via the MICT are marked by a switch symbol. Depending on the device version, some functions might not be available.

Per schedule:

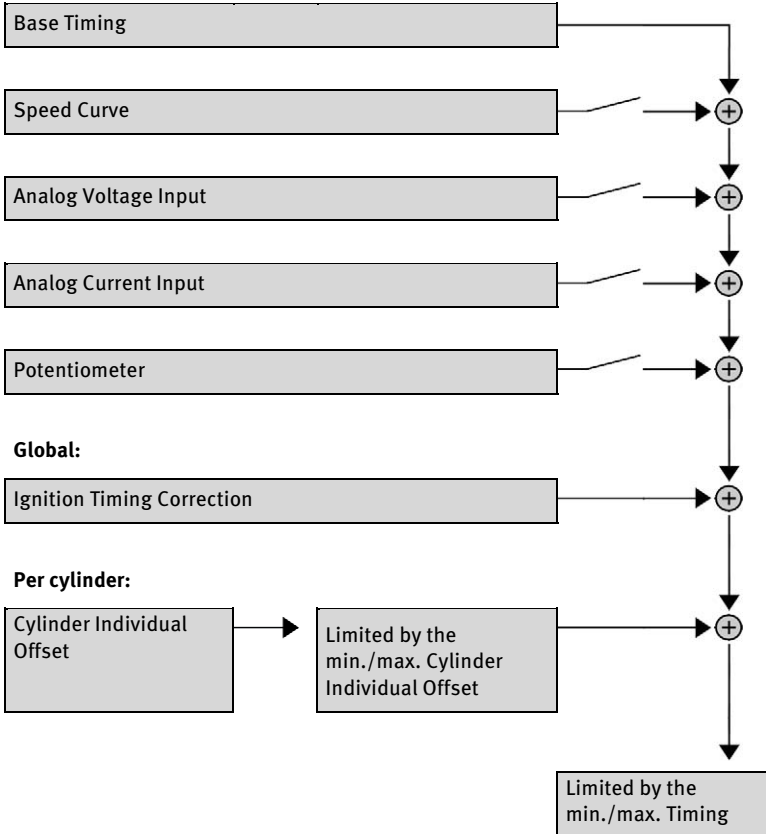

7.4.1 Analog Inputs

The timing point control can be adjusted with a linear current signal. This signal can be supplied, for example, by a potentiometer, a pressure sensor for charging pressure, or a detonation controller.

With the analog process signal (current loop signal) at the analog current input, the timing point can be offset in the advanced or retarded direction within a defined range.

7 Functions

Similarly or additionally, the timing can also be influenced by an analog voltage signal at the corresponding input.

The levels of the analog inputs can be set in the range from 0 mA to 20 mA and 0 V to 10 V. You can make this configuration with the MICT. Refer to the section *Timing – Analog Inputs* on page 95.

At the voltage output (*Analog Power*), a configurable auxiliary voltage is supplied that can be used for supplying power to external sensors.



Configuration examples

In this example the analog inputs are configured in the *Timing – Analog Inputs* window as follows:

- Input current: 4-20 mA
- Input voltage: 0-5 V

Characteristic 4-20 mA / 0-5 V – Ignition timing adjustment toward *retarded*.

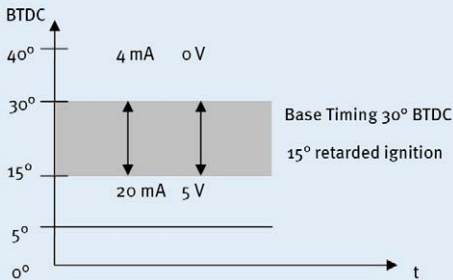

Characteristic 4-20 mA / 0-5 V – Ignition timing adjustment toward *advanced*.

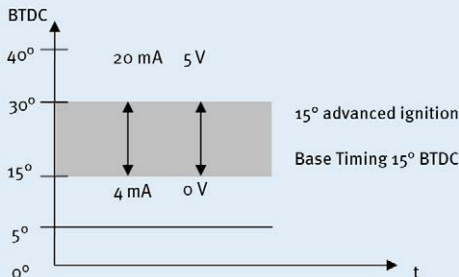

7.4.2 Cylinder-to-Cylinder Alignment

The cylinder-to-cylinder alignment enables the user to change the timing for individual cylinders to optimize their combustion.

You can enter the settings for the cylinder-to-cylinder alignment with the MICT. Please refer to the chapter *Cylinder Individual Offsets* on page 144.



Use of measuring unit

Use this setup option only if a suitable measuring unit is available for determining the optimum timing point, so that the result of a change can be assessed immediately.

7.4.3 Speed Curve

To optimize the ignition, for example, during the start phase of the engine, a speed curve can be defined for the MIC3+ ignition controllers. To create this curve, up to eight adjustable speed points are available.

You can configure the speed curve with the MICT. Refer to the section *Timing – Schedule A/B – General* on page 97.

7.4.4 Ignition Timing Correction

Via the ignition timing correction, the global ignition timing, limited by the timing limits of the current schedule, can be adjusted. Refer to the section *Runtime Adjustments – Timing* on page 140.

7.5 Firing Angle

The min. distance between two ignition angles depends on the overspeed. The smallest ignition spacing per output bank can be calculated using the following formula:

$$\text{Ignition Angle} = \frac{\text{Overspeed} [\text{min}^{-1}]}{60} \times 360^\circ \times 1.7 \text{ ms}$$

7.6 HV-Power Supply Error Monitoring

The voltage applied is monitored for excess voltage or low voltage by the integrated power supply. For both errors a Power-Fail error is saved and the device shuts off.

7 Functions

7.7 Output Monitoring

Electronic switches are used for the ignition outputs of the MIC₃₊ ignition controller. If one of these switches is defective, this would lead to a primary short or a primary open output. This can cause problems when operating the engine or can damage the engine. The function of the outputs is therefore monitored and errors that occur are displayed in the runtime data in the MICT or can be transmitted via field buses. Different alarms are available for monitoring the misfire rate. It can also be defined that the ignition is switched off in the event of output errors. Refer to the section *Inputs/Outputs – Alarms* on page 101.

7.8 Schedules A/B

The MIC₃₊ ignition controllers offer two separate schedules for the parameterization of the ignition timing and energy.

By closing input *Schedule A/B*, the listed parameter settings for schedule B can be selected. A possible application for this is e.g. operation with different gases. If only one schedule is configured, this is used regardless of the switch position.

You can configure the schedules with the MICT. Refer to *Timing – Schedule A/B – General* on page 97 and *Timing – Schedule A/B – Energy* on page 99.



Operational safety!

If you use schedules A and B, the advanced timing point should be linked to schedule B (switch closure). If a wire ruptures, schedule A is automatically selected with the retarded (and thus safer) timing point.

7.9 Alarms

The MIC₃₊ ignition controllers include 16 freely configurable alarms in total. These alarms can be freely allocated to the general purpose output (GPO) and set depending on the following functions:

- Limit for speed exceeded/not reached
- Limit for engine operating hours exceeded/not reached
- Limit for spark plug operating hours exceeded/not reached
- Warning active
- Error active
- Limit for temperature exceeded/not reached
- Limit for supply voltage exceeded/not reached
- Limit for global ignition timing exceeded/not reached
- Limit on the analog voltage input exceeded/not reached

- Limit on the analog current input exceeded/not reached
- Limit of the minimum spark duration exceeded/not reached
- Misfire rate (primary, single output) over limit
- Misfire rate (primary, all outputs) over limit
- Misfires per second (primary, all outputs) above threshold
- Consecutive misfires (primary, single output) above threshold
- Misfire rate (secondary, individual output) above threshold
- Misfire rate (secondary, all outputs) above threshold
- Misfires per second (secondary, all outputs) above threshold
- Consecutive misfires (secondary, single output) above threshold

A hysteresis can be defined for some alarms. You can configure the alarms with the MICT. Refer to the section *Inputs/Outputs – Alarms* on page 101.

7.10 GPO: General Purpose Output

The function of the general purpose output (GPO) can be set as desired as normally closed or normally open. The GPO can be used for the freely definable alarms.

You can enter the settings for the general purpose output with the MICT. Refer to the section *Inputs/Outputs – Alarms* on page 101.

7.11 ASO: Auxiliary Synchronization Output

The ASO is an output of the MIC3+ for synchronizing the MIC3+ ignition controller and a connected control unit. The possible applications include detonation control, valve control, and fuel injection control.

The ASO signal is low-active, i.e. the pulse width is defined as the time difference between the raising and falling edge (pulse width = $t_{\text{raising}} - t_{\text{falling}}$). The raising edge of the signal marks the configured engine rotation angle. With the variable pulse width, the values can be allocated to the engine rotation angle. A max. of 12 pulses can be configured for this purpose.

The pulse width is known at the time of the active edge, as the falling edge of the signal precedes the raising edge by the value of the pulse width. The controller calculates the duration of the falling edge from high-level to low-level and then back to the starting value of the high-level.

The ASO signal can be inverted via the configuration. It will then be high-active.

You can configure the auxiliary synchronization output with the MICT. Refer to the section *Inputs/Outputs – ASO1 (Auxiliary Synchronization Output)* on page 103.

7 Functions



Application of the ASO signal

The following example will illustrate the application of the ASO signal:

- Four-stroke engine with 6 cylinders
- Ignition angle $120^\circ - 120^\circ$

Synchronization between MIC₃₊ and Valve Controller

Cyl.	Ignition angle in °crankshaft	ASO signal in °crankshaft	Pulse duration in μs
1	0/720	718	160
2	120	118	80
3	240	238	80
4	360	358	80
5	480	478	80
6	600	598	80

Schematic Representation (Standard Settings)

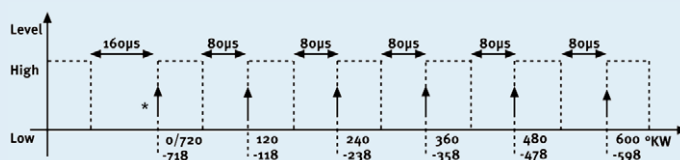

*) active edge

The valve controller should receive the active edge of the ASO signal before the top dead center of a cylinder. The first pulse duration should be twice as long and thus mark the beginning of a cycle. The ASO signal generated by the MIC₃₊ increases by 2° each time before the ignition signal from Low to High, as can be seen in the schematic drawing. This edge is analyzed by the valve controller as the active edge.

The ASO signal drops in accordance with the configured pulse duration from High to Low before the active edge. The valve controller then has already measured the pulse duration of the active edge and can provide information on the allocation of the signal. In the example shown here, the first cylinder is marked with a pulse width of $160 \mu\text{s}$ versus $80 \mu\text{s}$ for other cylinders. If the valve controller measures a pulse width of $160 \mu\text{s}$, the subsequent signal is therefore allocated to the first cylinder. The next signal then corresponds with the second cylinder in the ignition sequence, etc.

7 Functions

7.12 Ignition Energy

The ignition energy can be set separately for the start phase and normal operation. Here different settings can be made for schedules A and B.

You can configure the ignition energy with the MICT. Please refer to the section *Timing – Schedule A/B – Energy* on page 99.

7.13 Access Control

The MIC3+ has four operating levels, three of which can be secured with different PINs. As a default setting, the access control is not activated. If the access control for the MIC3+ is activated, it is independent from the access levels that control authorizations within the MICT.



Access control in the MICT and on MIC3+

A user is logged in to the *Advanced Service* access level on the MICT. He changes a configuration and would like to download the change to the MIC3+. Although he has the full authorization set in the MICT, he is prompted to log in with the PIN for the *Level 3 (Master)* on the MIC3+.

A variety of functions are at your disposal in the four operating levels of the MIC3+ . The figure below illustrates this:

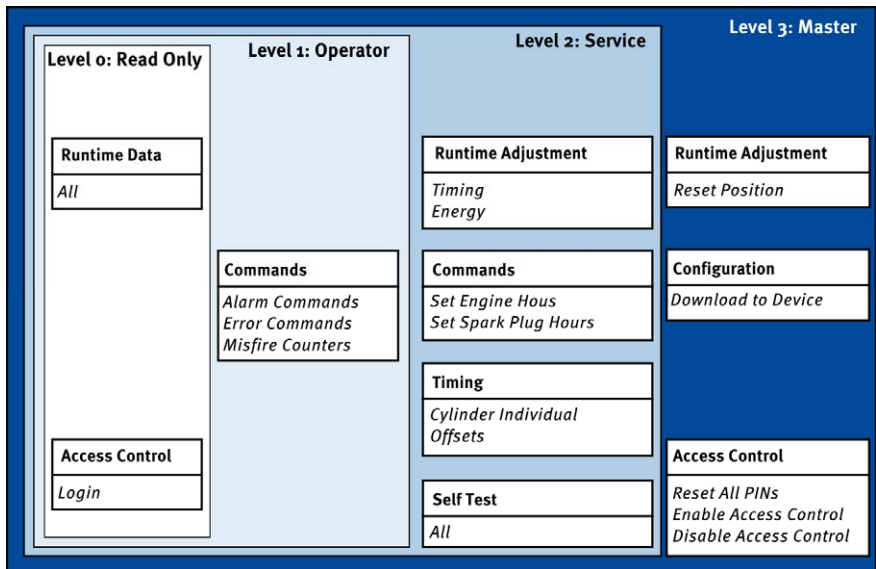

7 Functions

The following functions are available on the different levels:

- **Level 0 (Read Only)**
Enables read-only access for all users.
- **Level 1 (Operator)**
The user can operate the Alarm Commands, Error Commands, and the Misfire Counter on this level.
- **Level 2 (Service)**
Only the Service level has access to modifications of the runtime adjustments for Timing and Energy and the commands Set Engine Hours, Set Spark Plug Hours. The Cylinder Individual Offsets and the Settings for Self Test can also be executed in this operating level.
- **Level 3 (Master)**
On this level, the Master can, in addition to the other adjustments, modify the Reset Position and Reset All PINs and Enable/Disable Access Control. This authorization is also needed to transfer a configuration to an ignition controller.

For information on the access levels in the MICT, refer to the section *Access Levels in the MICT* on page 66.

8 Settings via the MICT



MICT is an abbreviation for *MOTORTECH Integrated Configuration Tool*. With the MICT, you can configure your ignition controller, and you can view and adjust the operating data of your engine. When working with the MICT, you can press the F1 key at any time to access context-sensitive help.

If you are using a different version of the MICT than shown in the following sections, the scope of functions may differ.

8.1 MICT System Requirements

For the installation of the MICT, the following minimum requirements must be fulfilled:

- x86-compatible computer, at least performance class Intel Pentium 4 with 2 GHz
- 128 MB free RAM
- 250 MB free disk space
- USB interface 1.1 or higher
- Display with a resolution of at least 1440 x 900 pixels (WXGA+)
- Microsoft® Windows 7, Windows 10

8.2 MICT Installation

The software for the installation of the MICT is on the storage device (USB flash drive or CD-ROM) provided with the ignition controller.

To install the MICT, proceed as follows:

1. Start the installation:
 - Via the menu:
Start the file *Start.exe* on the storage device. Start the installation routine of the MICT via *Software -> Install MICT*.
 - Directly from the storage device:
Start the installation routine of the MICT directly. It is on the storage device in the subdirectory *Installation* and for example named as follows: *MICT-2.42.2-setup.exe*.
2. Run the installation.
Follow the instructions of the installation routine. Note that the license agreement terms must be accepted before using the MICT.
3. Install the USB driver via the menu as well or directly from the storage device.
 - Via the menu:
Software -> USB Drivers -> Install USB Drivers
 - Directly from the storage device:
Start the exe file in subdirectory *Drivers* (e.g. *CDM21226_Setup.exe*).
 - ▶ The MICT is set up. You can connect your PC to the ignition controller via the USB interface.

8 Settings via the MICT

8.3 Access Levels in the MICT

You can open the MICT on your computer via *Start -> Programs -> MOTORTECH -> MICT 2.x.x -> MICT 2.x.x*.

After opening the MICT, select the access level for which you have clearance. The access level controls the options you have at your disposal in the MICT. The password required for access can be obtained from your MOTORTECH contact person (refer to *Customer Service Information* on page 159).

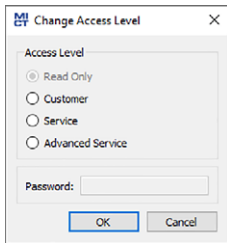

The following access levels are available:

- **Read Only**
On this level, the user can open a configuration and transfer it to the device. However, he cannot make changes to the configuration. The user has read-only access to all other settings.
- **Customer**
This level enables the configuration of the basic functions required for operation in addition to the read-only function.
- **Service**
This level contains all functions for a standard installation.
- **Advanced Service**
This level offers full access to all functions of the MICT and is enabled and accessible for specially trained personnel only.

The following sections describe the options at your disposal with the *Advanced Service* access level. If you have registered for a different level, you cannot execute all functions shown.

8 Settings via the MICT

8.4 Configuration Pages (Overview)

The configuration pages are divided into the following sections:

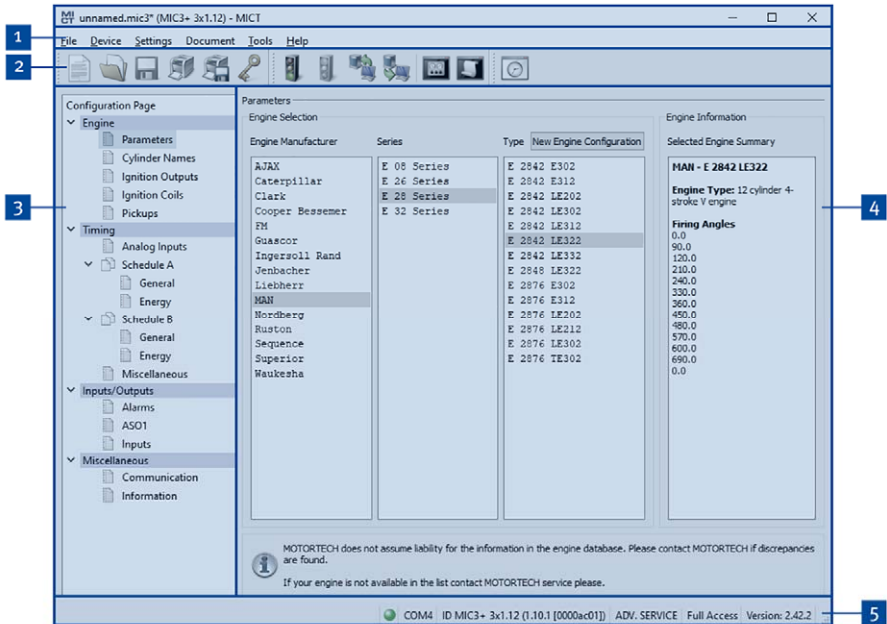

Pos.	Area
1	Menu bar
2	Toolbar
3	Navigation bar
4	Configuration section
5	Status bar

The functions in the menu bar, navigation bar and the toolbar as well as the configuration section will be described in the following.





8 Settings via the MICT

The status bar provides you with the following information (from left to right):











- Status display
Indicates whether a connection is established with the device:
 - Green: Connection established
 - Red: The connection was interrupted and is being restored
 - Gray: The connection is not established and is not being restored
- Indication of the interface being used for the connection to the device
- Indication of the device ID
- Indication of the access level of the user in the MICT
- Indication of the operating level for the MIC₃₊ if access control has been activated and the user has logged on with a PIN.
- Indication of the MICT program version

8.5 Menu Bar and Toolbar

The following functions are available to you via the symbols on the toolbar and the entries in the menu bar:

Symbol	Menu	Function
	<i>File -> New</i>	Creates a new configuration.
	<i>File -> Open</i>	Opens an existing configuration.
	<i>File -> Save / File -> Save As</i>	Saves the current configuration.
	<i>File -> Recent Documents</i>	The last five configuration files used are offered for selection.
	<i>File -> Close</i>	Closes the current configuration.
	<i>File -> Open trace</i>	Opens a runtime data record (trace file). Refer to the section <i>Runtime Data</i> on page 109.
	<i>File -> Open pickup trace</i>	Opens a saved record of pickup signals (putrace file). Refer to the section <i>Pickup Trace</i> on page 74.
	<i>File -> Change Access Level</i>	Changes the MICT access level for accessing the configuration data and functions.

8 Settings via the MICT

Symbol	Menu	Function
	<i>File -> Print</i>	Prints the current configuration.
	<i>File -> Print To PDF File</i>	Prints the configuration to a PDF file.
	<i>File -> Print Preview</i>	Opens a print preview of the configuration.
	<i>File -> Quit</i>	Exits the MICT.
	<i>Device -> Connect</i>	Connects to the device.
	<i>Device -> Disconnect</i>	Cuts the connection to the device.
	<i>Device -> Download to device</i>	Downloads configuration data from the computer to the device. Refer to <i>Working with Configurations</i> on page 78.
	<i>Device-> Upload from device</i>	Uploads configuration data from the device to the computer. Refer to <i>Working with Configurations</i> on page 78.
	<i>Device -> Runtime data</i>	Opens the window <i>Runtime Data</i> . Refer to the section <i>Runtime Data</i> on page 109.
	<i>Device -> Log</i>	Opens the window <i>Log (Advanced Service only)</i> . Refer to the section <i>Log</i> on page 137.
	<i>Device -> Runtime adjustments</i>	Opens the window <i>Runtime Adjustments (Service and Advanced Service only)</i> . Please refer to the section <i>Runtime Adjustments</i> on page 138.
	<i>Device -> Cylinder individual offsets</i>	Opens the window <i>Cylinder Individual Offsets (Advanced Service only)</i> . Please refer to the chapter <i>Cylinder Individual Offsets</i> on page 144.
	<i>Device -> Self test</i>	Opens the window <i>Self Test (Service and Advanced Service only)</i> . For this refer to section <i>Self Test</i> on page 72.

8 Settings via the MICT

Symbol	Menu	Function
	<i>Device -> Pickup trace</i>	Loads the automatically recorded pickup signals from the device. Refer to the section <i>Pickup Trace</i> on page 74.
	<i>Device-> Set spark plug operating hours</i>	Opens the window <i>Set spark plug operating hours</i> .
	<i>Device -> Set engine operating hours</i>	Opens the window <i>Set Engine Operating Hours</i> .
	<i>Device -> Set date and time</i>	Opens the window <i>Set Date and Time</i> , in which you can set the clock in the device.
	<i>Device -> Send command -> Reset misfire counters</i>	The misfire counters of all ignition controller outputs are reset and restarted. Misfires that previously occurred at the outputs are no longer displayed.
	<i>Device -> Send command -> Acknowledge operational error</i> (Keyboard shortcut: <i>Strg+R</i>)	All operational errors are acknowledged. This can only be implemented while the engine is not running.
	<i>Device -> Access Control</i>	The setup for the access control to the MIC3+ is described in a separate section. Please read the section <i>Access Control for MIC3+</i> on page 76.
	<i>Device -> Temperature Extremes</i>	Opens the window <i>Temperature Extremes</i> in which the minimum and maximum temperatures of the controller and output boards are displayed.
	<i>Settings -> Language</i>	Opens the window <i>Select Language</i> in which you can change the interface language of the MICT.
	<i>Settings -> Online update settings</i>	Opens the window <i>Online Update Settings</i> . Refer to the section <i>Online Update Settings</i> on page 71.
	<i>Settings-> Database settings</i>	Opens the window <i>Database Settings</i> in which various databases can be assigned as source for the MICT.
	<i>Settings -> Temperature scale</i>	Opens the window <i>Select Temperature Scale</i> , in which you can change the unit for the temperatures shown in the MICT.

8 Settings via the MICT



Symbol	Menu	Function
	<i>Settings -> Display by cylinders</i>	Not currently used.
	<i>Document -> Schedule Curve</i>	Opens the window <i>Schedule</i> . Please refer to the chapter <i>Schedule Curve</i> on page 145.
	<i>Tools -> Coils</i>	Opens a database with information on MOTORTECH ignition coils.
	<i>Help -> Help</i>	Opens the online help function.
	<i>Help -> About MICT</i>	Opens detailed information on the MICT.

8.6 Online Update Settings



Perform regular online updates

MOTORTECH is constantly expanding its databases. Perform regular online updates to make optimal use of the opportunities that the MIC3+ provides.

The MICT uses data from an engine database and a coil database for the configuration. Such data can be updated with automatic online updates. The settings for the update can be entered with the following entry in the menu bar:

Settings -> Online update settings

You have the following options:

- **Enable automatic database updates**
Using the check box, you can enable and disable automatic online updates. As the default setting, the online update is activated and is executed daily (if an internet connection is established) at first start-up of the MICT.
- **Use a proxy to access the web**
Use the checkbox to activate settings for internet access via a proxy server, which you can then set up by entering *http-Proxy* and *Port*.

8 Settings via the MICT

- [Show Log](#)
With this button, you can open a window in which the online updates performed are logged.
- [Update Now](#)
With this button, you manually start an online update.

8.7 Self Test



Operational safety!

If you carry out a self test, it is essential for the gas supply to be switched off and no more residual gas is left in the combustion chamber. Non-compliance can result in damage to equipment or injury to persons.

You can run the self test via the MICT to check the order of the wiring and the connection between the ignition controller outputs and the spark plugs.

Proceed in the MICT as follows:

Device -> Self test

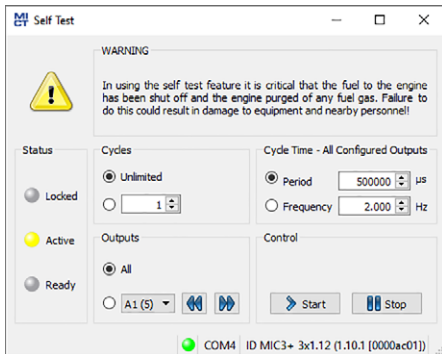

The following information is provided:

Status

The status displays indicate whether the ignition controller is ready for the self test.

- [Locked](#)
The ignition controller is in a state in which no self test can be done. For example, there is an error or a configuration is currently being downloaded into the device.

■ 8 Settings via the MICT



- **Active**
The self test is running.
- **Ready**
The ignition controller is ready and the self test can be started.

You have the following options:

- **Cycles**
Determine whether the self test should run *unlimited* or be terminated after a defined number of cycles.
- **Outputs**
Define whether *all* outputs or only a defined output should be fired during the self test.
- **Cycle Time - All Configured Outputs**
Specify the cycle time either as a *period* or *frequency*. The value entered always refers to a complete cycle. That means that all outputs that are configured are fired once per cycle. If you only set one output for the self test, this would still only fire once per cycle.
- **Control**
Start or stop a self test using the corresponding buttons.

8 Settings via the MICT

8.8 Pickup Trace

The traces of the pickup signals support you in checking the behavior of the used pickup and thus, for example, to detect and analyze irregularities or failures.

Pickup signals are automatically recorded by the ignition controller as soon as they are detected at the configured inputs. Ten further signals are recorded if an error occurs during operation (cumulative across all inputs). The recording is then stopped so that the pickup signals just before the error can be analyzed. The records can be downloaded from the device at any time.

Proceed in the MICT as follows:

Device -> Pickup trace



Pickup trace

Example of a pickup trace for a configuration with two pickups:

- Pickup input 1 (cam):
Single event from the camshaft
- Pickup input 2 (trigger):
Trigger disc type N-1 with 160-1 events from the crankshaft

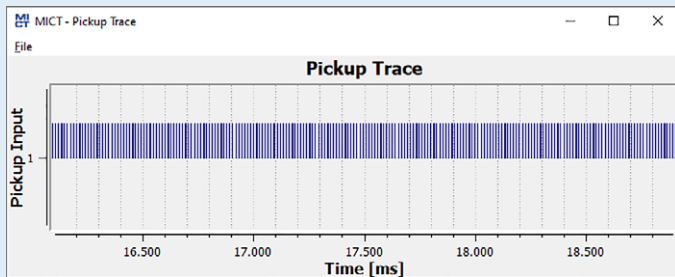

Operation

The following options are available via the menu in the window:

- **Open**
Opens a previously saved pickup trace.
- **Save as**
Saves a pickup trace as a .putrace file.
- **Close**
Closes the pickup trace.

8 Settings via the MICT

There are the following options for the display of the pickup signals:

- **Zoom In/Out**
Using the mouse scroll wheel you can zoom in and out of the displayed record range. Alternatively you can also use the plus and minus keys on the keyboard. With the zoom function, you can e.g. analyze the trigger signal more precisely (see figure).

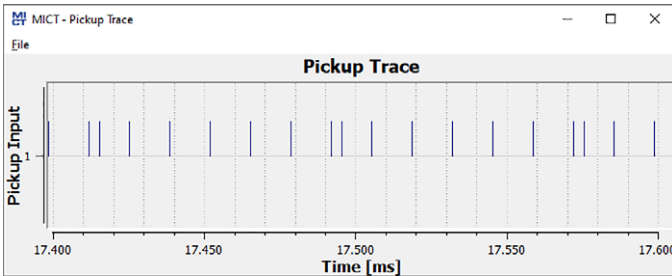

- **Move displayed range**
With the right mouse button pressed you can move the displayed range along the time axis.
- **Measuring**
You can measure distances and the number of events in the displayed range by holding down the left mouse button to highlight a section. You can find the following information in the window:
 - Position on the time axis
 - Time difference (Δ) between the two selected points
 - Number of events counted in the selected period

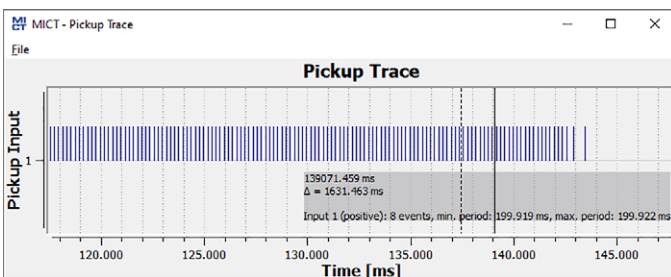

Error Analysis

The pickup traces support you, for example, in analyzing the following errors:

- Configuration of the pickup does not agree with the wiring (e.g. trigger disc configuration, allocation of the inputs, allocation of the shafts). In this case, you should compare the values configured with the signals recorded (see *Engine – Pickups* on page 91).
- One or more pickups have failed.

8 Settings via the MICT



Pickup trace

The pickup signals are only recorded on the inputs that are configured in the MICT. No signals are recorded if the pickup input configuration is not valid.

8.9 Access Control for MIC3+

If the access control to the MIC3+ is activated, access to the following areas is possible with a PIN only:

- **Runtime Adjustment** (Reset, timing, energy, secondary voltage estimation calibration and secondary short calibration)
- **Commands** (Alarms, error commands, set engine/spark plug operating hours, and self test).
- **Configuration** (Transferring a configuration to the MIC3+)

The access control regulates the accesses to the device via the MICT. For explanations concerning access control of the MIC3+ and the delimitation of the access levels in the MICT, refer to section *Access Control* on page 63.

The access control functions can be accessed in the menu bar via:

Device -> Access Control

8.9.1 Enable/Disable Access Control



Enable/Disable access control

As a default setting, the access control is not activated, and all PINs are set to 0000. Once the access control has been activated, and the PINs were changed, these PINs will continue to be used. To activate the access control again, you will need the PIN for level 3 (*Master*). It is therefore recommended to reset all PINs before disabling.

If that was not done, or a system must be unlocked for another reason, a request key can be issued in the MICT. Refer to the section *Reset all PINs* on page 77.

To enable or disable the access control, proceed as follows:

1. Open the input dialog via *Device -> Access Control -> Enable or Disable access control*.
2. Enter the PIN for the level *Master (Level 3)*.
3. Confirm the input with OK.

8 Settings via the MICT



8.9.2 Login/Logout

If the access control is activated, you are prompted to log in if you want to execute functions that are allocated to a specific operating level. In addition, you can log in specifically to an operating level via the menu bar.

To log into a specific operating level, proceed as follows:

1. Open the input dialog via *Device -> Access Control -> Login*.
2. First select the level you wish to log on to.
3. Enter the PIN for the desired level.
4. Confirm the input with OK.
 - ▶ You are now logged into the corresponding level and can execute all functions that are allocated to this operating level without having to log in again.

After completing the log-in, you can log out again as follows:

Device -> Access Control -> Logout

8.9.3 Changing the PIN

To change the PIN for a specific operating level, proceed as follows:

1. Open the input dialog via *Device -> Access Control -> Change PIN*.
2. First select the level for which you wish to change the PIN.
3. Enter the current PIN for the desired level.
4. Enter the new PIN in the two subsequent fields.
5. Confirm the input with OK.
 - ▶ The PIN for this operating level has now been changed.

8.9.4 Reset all PINs

To reset all PINs, proceed as follows:

1. Open the input dialog via *Device -> Access Control -> Reset all PINs*.
2. If you are not yet logged into the *Master (level 3)* level, you will be prompted to log in with the relevant PIN.
3. Confirm the input with *OK*.
4. To reset all PINs, you will be prompted again to enter the PIN for the level *Master (Level 3)*.
5. Confirm the input with *OK*.
 - ▶ All PINs are now reset to the value *0000*.

8 Settings via the MICT

To reset all PINs, you need the PIN for the level *Master (level 3)*. To be able to unlock a system in case of emergency that was locked in this way, you have the following option:

1. In the menu bar, select the entry *Device -> Access Control -> Get reset all PINs request key* to open a window with the same name.
2. Send the request key with the serial number to your service contact person at MOTORTECH (refer to *Customer Service Information* on page 159). This key is valid only for the respective controller and only for a certain amount of time.
 - ▶ Your information will be verified, and you will receive an authorization key from your contact person.
3. From the menu bar, select the entry *Device -> Access Control -> Set reset all PINs authorization key* to open a window with this name.
4. Enter the authorization key received in the input field.
5. Confirm the input with *OK*.
 - ▶ If the input was correct, all PINs are reset to the default value *0000*.

8.10 Working with Configurations

To ensure that the MIC3+ correctly interprets incoming data and correctly controls the ignition system, it requires information about the engine and the ignition system. This information is stored in the MIC3+ as configuration data.

You can use the MICT to perform the following for these configurations:

- Create
- Open
- Edit
- Save as a file
- Download to the MIC3+
- Upload from the MIC3+

8 Settings via the MICT



8.10.1 Create, Open, Save



Click on the symbol to create a new configuration and select the corresponding device type. The device type corresponds to the first five digits of the arrangement number, which you can find on a label on your device.

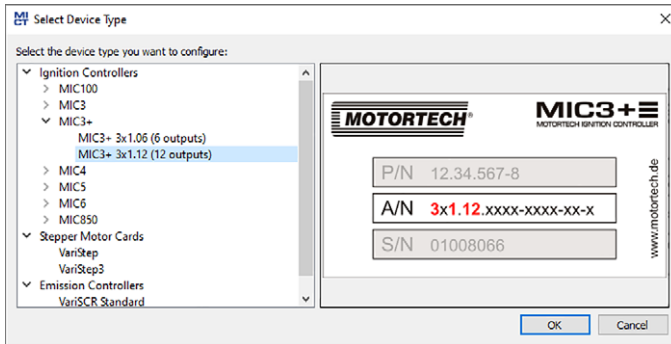

Click on the symbol to open a saved configuration.

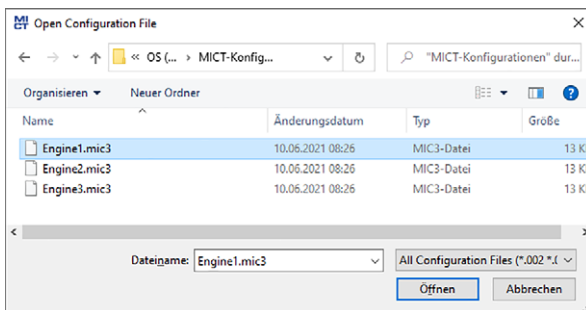

Click on the symbol to save the configuration currently displayed in the MICT to a storage device.

8 Settings via the MICT



Compatibility of the configuration files

Configuration files are only compatible for the respective device type, even if the file extension is identical. For example, files created for a MIC₃ cannot be downloaded to a MIC₃₊ and vice versa.

To use a configuration for another device, the series and the first four digits of the arrangement number must match. This information can be found in the title bar of the configuration and on the respective device:

MIC₃

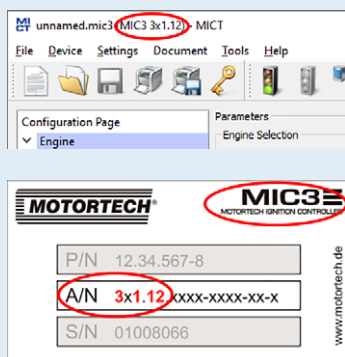

MIC₃₊

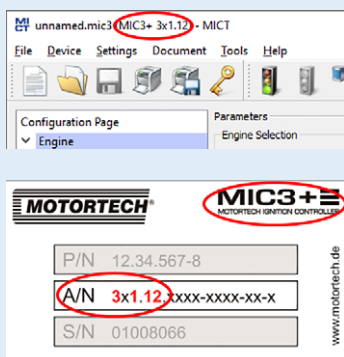

If, for example, a system is to be changed from a MIC₃ to a MIC₃₊, the configuration of the MIC₃ can be saved as a PDF file. Then a new configuration file must be created for the MIC₃₊ and the values from the PDF file must be entered. Alternatively, the MICT can be opened twice and the values transferred to a newly created configuration file.

8.10.2 Upload, Download



Click the symbol to upload the current configuration from the MIC₃₊ to the MICT. If applicable, the MICT first establishes a connection to the MIC₃₊ connected.



Click on the symbol to download the configuration set in the MICT to the MIC₃₊. This function can only be executed while the ignition is not active. This action overwrites the existing configuration on the device. If applicable, the MICT first establishes a connection to the MIC₃₊ connected.



Existing configuration is cleared!

If you download a configuration to a MIC₃₊, the previous configuration is deleted and the new settings are immediately implemented.



Runtime adjustments

If you change a configuration stored in the MIC₃₊ via runtime adjustments, the configuration must be re-uploaded from the device so that the changes are displayed in the MICT's configuration views.

8.10.3 Compatibility Information



If you upload a configuration from the MIC₃₊ to the MICT that does not correspond to the status of your MICT, or if you open this type of configuration in the MICT, the following situations may occur:

- No values are present in the configuration for certain MICT functions. The MICT assumes the standard values for these functions.
- The configuration contains function values that are not support by the MICT.

The following situations can occur if you download a configuration from the MICT to a MIC₃₊ whose firmware does not correspond to the status of your MICT:

- No values are present in the configuration for certain firmware functions. The firmware continues to use the preset values for these functions.
- The configuration contains function values that are not support by the firmware.

If you download a configuration into the MIC₃₊ and are notified of functions that are not supported by the MICT, you should check the MIC₃₊ settings. Re-upload the configuration from the MIC₃₊ to the MICT. You can then see which settings are not transmitted to the MICT.

Perform a firmware update, if necessary, and/or update your MICT so that you can use all the MIC₃₊ functions without restriction.

8 Settings via the MICT

8.11 Configuration

The window opens after you select the device type for a new configuration or an existing configuration or have uploaded one from the ignition controller. You can make changes to the configuration by selecting an entry from the navigation bar. The corresponding configuration data are then displayed in the configuration section and can be processed. The following sections will describe the settings and adjustments you can implement in the different areas.



Indication of invalid entries

An invalid selection or invalid input values are highlighted by pulsating warning signs on the configuration pages of the MICT. Additional information is provided in the status bar.

Example:

The screenshot shows the 'Ignition Outputs' configuration page for 'Output Bank A'. The 'Number of Outputs' is set to 8. A table lists 8 outputs, each with a value of 0.0 and a warning icon. The status bar at the bottom displays an error message: 'Ignition Angle: 0.0 - 720.0, Default = 0.0, min. distance limited by overspeed (invalid due to con...'.

Output	Angle [°]
1	0.0
2	0.0
3	0.0
4	0.0
5	0.0
6	0.0
7	0.0
8	0.0

Ignition Angle: 0.0 - 720.0, Default = 0.0, min. distance limited by overspeed (invalid due to con... COM n/a ID n/a ADV. SERVICE n/a

8 Settings via the MICT



8.11.1 Engine – Parameters

The screenshot shows the MICT software interface for engine configuration. The main window is titled "unnamed.mic3+ (MIC3+ 3x1.12) - MICT". The menu bar includes File, Device, Settings, Document, Tools, and Help. The left sidebar shows a tree view with "Engine" selected, and "Parameters" is the active sub-item. The main area is divided into three sections:

- Engine Selection:** A table with columns for Engine Manufacturer, Series, and Type. The "New Engine Configuration" column is currently empty.
- Engine Information:** A panel showing the "Selected Engine Summary" for the chosen engine: **HAN - E 2842 LE322**. It lists the engine type as "12 cylinder 4-stroke V engine" and provides firing angles for various cylinders.
- Footer:** A disclaimer from MOTORTECH and a status bar showing "COM4 | ID MIC3+ 3x1.12 (1.10.1 [0000ac01]) | ADV. SERVICE | Full Access | Version: 2.42.2".

Engine Manufacturer	Series	Type	New Engine Configuration
AJAX	E 08 Series	E 2842 E302	
Caterpillar	E 26 Series	E 2842 E312	
Clark	E 28 Series	E 2842 LE202	
Cooper Beasemer	E 32 Series	E 2842 LE302	
FM		E 2842 LE312	
Guascor		E 2842 LE322	
Ingersoll Rand		E 2842 LE332	
Jenbacher		E 2848 LE322	
Liebherr		E 2876 E302	
HAN		E 2876 E312	
Nordberg		E 2876 LE202	
Ruston		E 2876 LE212	
Sequence		E 2876 LE302	
Superior		E 2876 TE302	
Waukesha			

Selected Engine Summary
HAN - E 2842 LE322
Engine Type: 12 cylinder 4-stroke V engine
Firing Angles
0.0
90.0
120.0
210.0
240.0
330.0
360.0
150.0
480.0
570.0
600.0
690.0
0.0

MOTORTECH does not assume liability for the information in the engine database. Please contact MOTORTECH if discrepancies are found.
If your engine is not available in the list contact MOTORTECH service please.

COM4 | ID MIC3+ 3x1.12 (1.10.1 [0000ac01]) | ADV. SERVICE | Full Access | Version: 2.42.2

Engine Selection

The MICT holds an engine database with data from various manufacturers and model series. Select the desired engine manufacturer, series, and type by clicking on the corresponding fields.

8 Settings via the MICT

Wiring in firing order is assumed as standard. If straight order wiring is supported for the selected engine, the *Wiring* dialog opens and you have the opportunity to adapt the output configuration.

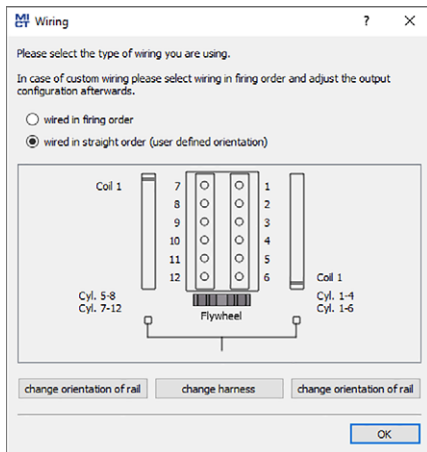

You can use straight order wiring, if:

- Wiring takes place via a corresponding MOTORTECH wiring harness and a MOTORTECH wiring rail. The harness is marked with the following information: *PLEASE NOTE! The firing order needs to be configured directly in the ignition controller.* The ignition coils on the wiring rail are marked with *Connector Pin 1* to *Connector Pin X*. The position of coil1 on the wiring rail is marked in the view *Wiring*.
- Wiring of the ignition controller is done corresponding to the instructions in section *Straight Order Wiring of the Ignition Outputs* on page 52 (for example with an open wiring harness or via a junction box).

The configuration of the ignition outputs is automatically adapted corresponding to your selection. If you want to use a different wiring, these settings must be adapted appropriately.

If the pertinent engine is not available in the database, settings can also be entered by selecting the corresponding sequence. For this purpose, click on the entry *Sequence* in the column *Engine Manufacturer* and select the firing stroke in the column *Series*, then the number of cylinders, and the ignition offset of the engine as needed. After making your selections, the right hand section *Engine Information* will display a summary of the parameters selected.

The summarized data are transferred to the subsequent configuration page *Ignition Outputs*. The values displayed there can only be changed by users with authorization to access the *Advanced Service* level.

8 Settings via the MICT



Engine database

MOTORTECH does not assume liability for the information in the engine database. Please contact MOTORTECH if discrepancies are found.

New Engine Configuration

Staff with the authorization for the *Advanced Service* level additionally has the option for entering the engine data manually, i.e., without selecting entries from the engine database. For this purpose, click on the *New Engine Configuration* button and select the engine type, number of cycles, and number of cylinders in the dialog box opening up. Additional information can be entered on the configuration page *Ignition Outputs*.

New Engine Configuration

Engine Type: V engine

Strokes: 4-stroke

Number of Cylinders: 12

Note: Specify Firing Order and Firing Angles on the Ignition Outputs Page!

OK Cancel

8 Settings via the MICT

8.11.2 Engine – Cylinder Names

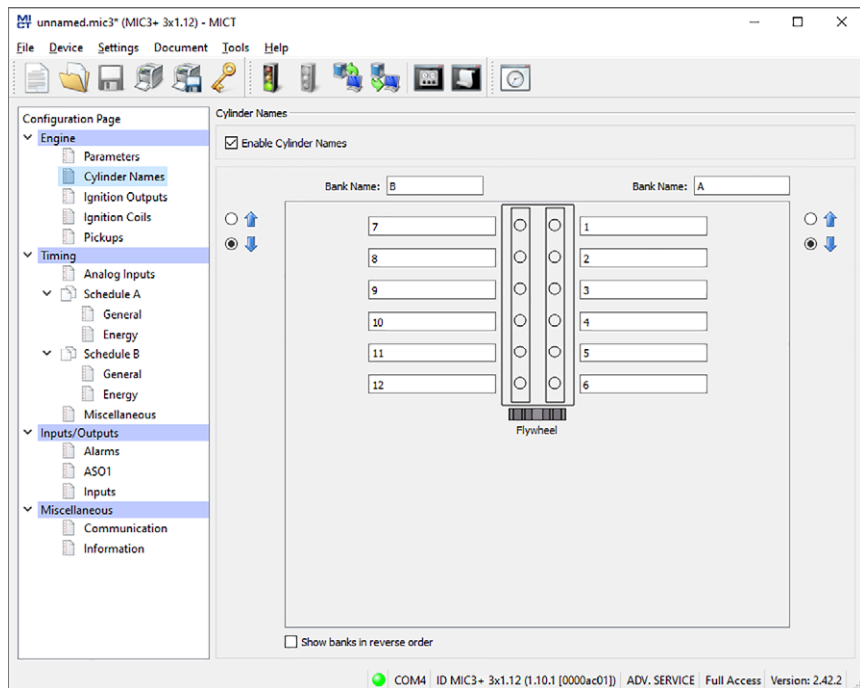

To facilitate the allocation of the cylinders during the configuration of the ignition outputs, you can individually name each cylinder. The schematic representation of the plan view of the selected engine supports you in this. Enter the following settings:

- **Enable Cylinder Names**
Activate the checkbox in order to assign cylinder names. In order to use this function, the number of cylinders must be defined. Establish the number of cylinders either by using a configuration from the engine database or by creating a new engine configuration via the corresponding button. Refer to the section *Engine – Parameters* on page 83. If you have activated the checkbox, the assigned cylinder names must also be assigned to the corresponding ignition outputs, before the configuration is transferred to the ignition controller. Otherwise there will be an error message. Refer to the section *Engine – Ignition Outputs* on page 87.
- **Bank Name**
Enter a name for the respective cylinder bank.
- **Cylinder Names**
Enter a name for the respective cylinder.

8 Settings via the MICT



-  currently not used
- Show banks in reverse order currently not used

8.11.3 Engine – Ignition Outputs

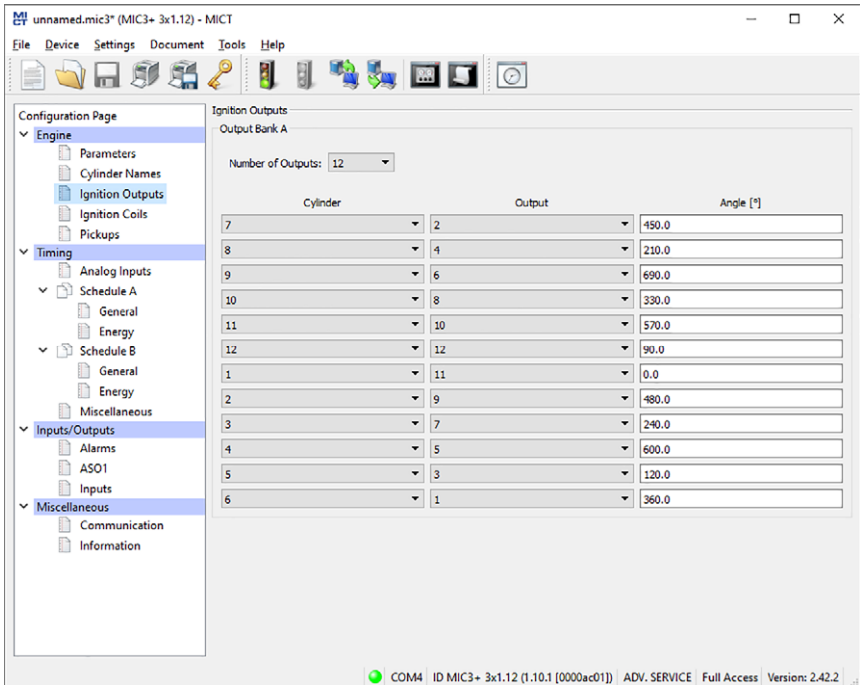

Configuration Page

- Engine
 - Parameters
 - Cylinder Names
 - Ignition Outputs**
 - Ignition Coils
 - Pickups
- Timing
 - Analog Inputs
 - Schedule A
 - General
 - Energy
 - Schedule B
 - General
 - Energy
 - Miscellaneous
- Inputs/Outputs
 - Alarms
 - ASO1
 - Inputs
- Miscellaneous
 - Communication
 - Information

Ignition Outputs

Output Bank A

Number of Outputs: 12

Cylinder	Output	Angle [°]
7	2	150.0
8	4	210.0
9	6	690.0
10	8	330.0
11	10	570.0
12	12	90.0
1	11	0.0
2	9	180.0
3	7	240.0
4	5	600.0
5	3	120.0
6	1	360.0

COM4 ID MIC3+ 3x1.12 (1.10.1 [0000ac01]) ADV. SERVICE Full Access Version: 2.42.2

Make adjustments to the following settings as needed:

- **Number of Outputs**
Select the number of outputs.
- **Column: Cylinder**
Select a cylinder. The displayed names are specified on the configuration page *Engine – Cylinder Names*.
- **Column: Output**
Select the number of the respective output.
- **Column: Angle**
Enter the firing angle for each output.

8 Settings via the MICT

Default Application

If you select from the engine database, the data stored for the selected configuration are displayed. These data can only be changed by personnel with access to the *Advanced Service* level.

New Engine Configuration

Selecting the number of outputs enables access to the fields for the configuration of the outputs. By default, the ignition outputs are distributed so that cylinder 1 of the ignition sequence is always allocated an ignition angle of 0° . The ignition angle for each output results from the addition of the ignition spacing to the respective previous output.



Operational safety!

Never connect more than one output to each ignition coil, as the output boards can otherwise be damaged.

The allocation of outputs to the device's output connector contacts and the cylinders is determined by the wiring. The user must take the wiring into account during the configuration; it cannot be checked by the software.



Interval between two ignitions

The interval between two ignitions must be min. 1.7 ms. During the check, the configured overspeed is used in the calculation.

8.11.4 Engine – Ignition Coils

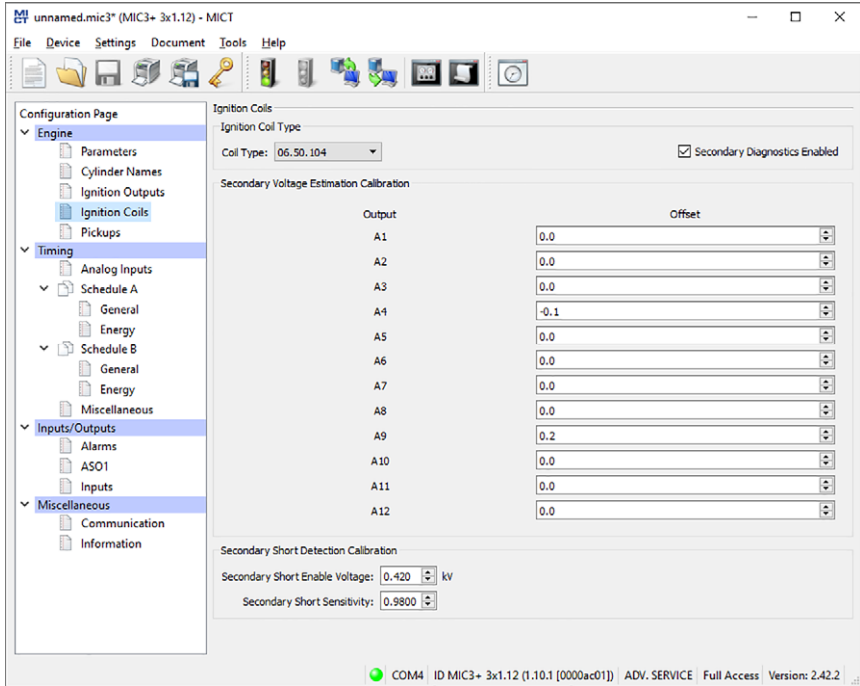

Ignition Coil Type

Select the ignition coil type from the drop-down list. (Without this selection the configuration cannot be downloaded to the MIC3+.)



Only use measured ignition coils

To operate the MIC3+, only ignition coil types measured by MOTORTECH may be used. All ignition coils used must correspond to the part number selected in the drop-down list. Different coil types must not be mixed and also no equivalent or replacement types may be used.

If a coil type used is not in the drop-down list, then the MIC3+ is currently not used.

■ 8 Settings via the MICT

Secondary Diagnostics Enabled

The secondary diagnosis can be deactivated and activated for ignition coils that support this function. If the ignition coil does not support this function, the secondary voltage estimation calibration and the of the secondary short calibration are not available.

Secondary Voltage Estimation Calibration

A correction value without units can be set for the secondary voltage estimation for every configured output to increase the accuracy of the secondary voltage estimation for each individual cylinder. This allows, for instance, different cable lengths on the engine to be compensated.

The values of the secondary voltage estimation can be changed for each individual cylinder. The value range depends on the ignition coil. 0.0 is set as the standard value for all cylinders. You can adjust the secondary voltage estimation while the engine is running in the runtime adjustments (refer to *Runtime Adjustments – Secondary Voltage Calibration* on page 142).

Secondary Short Detection Calibration

The starting voltage and the secondary short detection sensitivity can be adjusted. You can adjust the secondary short detection in the runtime adjustments while the engine is running (refer to *Runtime Adjustments – Secondary Short Calibration* on page 143).

Secondary Short Enable Voltage

Set the average ignition voltage required to activate the secondary short-circuit monitoring:

- The secondary short detection is always activated at a value of 0 kV.
- The secondary short detection is always deactivated at a value of 65.535 kV.

Secondary Short Sensitivity

The permitted value range depends on the set ignition coil.

Set the sensitivity of the short-circuit detection e.g. as follows:

- The sensitivity is high at a value of 0.98.
- The sensitivity is low at a value of 1.02.

8.11.5 Engine – Pickups

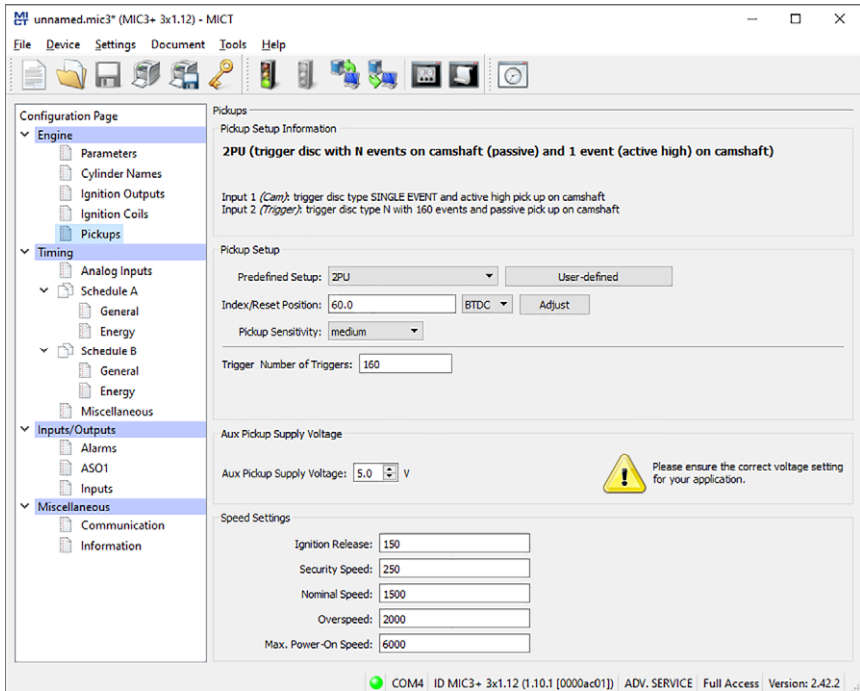

Active pickups

Check when using active pickups that the auxiliary supply voltage is configured for your application.

Pickup Setup Information

The settings made in the section *Pickup Setup* were summarized once again in the section *Pickup Setup Information*.

8 Settings via the MICT

Pickup Setup

Enter the following settings in this section:

- **Predefined Setup**
Select the pickup configuration suitable for your application from the list. The configurations available for selection depend on the previously entered settings.
- **Index/Reset Position**
Enter the distance between the first event after the set index/ reset marking and top dead center. With the button *Adjust*, you can enter the measured firing angle for a given nominal value. The system calculates the difference from these values, which is added to or subtracted from the index/reset position.
- **Pickup Sensitivity**
Open the pick list and select the desired sensitivity level for the pickup. This setting overwrites the value of the pre-trigger voltage if the latter was defined in the user-defined pickup setup.
 - **High**
The signal processing starts at low engine speeds. This setting can result in increased susceptibility to failure.
 - **Medium**
Default setting for MICT. This is a trade-off between start-up speed and sensitivity.
 - **Low**
The signal processing does not start until high engine speeds are reached. This setting can result in reduced susceptibility to failure.
- **Trigger/Cam No. of Triggers**
Enter the number of events. The input *Cam* or *Trigger* is automatically selected by the MICT and is governed by the selection of the pre-defined pickup settings.
- **User-defined**
Staff authorized to access the *Advanced Service* level can, in addition to the standard settings access, use a manual setup option by clicking on the button *User-defined*.

Input	Type	Number of Events	Speed	Active/Passive	Pre-Trigger [V]
Pickup Input 1 (Cam):	SINGLE EVENT	0	CAMSHAFT	active high	2.5
Pickup Input 2 (Trigger):	N	160	CAMSHAFT	passive	1.5

Trigger Disc Type, Default = NONE

- Type

You can select the type of events that will occur on this input for each pickup input. Type and number of events are defined by the discs or ring gears used. If you decide not to use a pickup input, select the entry *None* from the list. You can set the following types:

N
Disc, which causes a uniformly distributed number (N) of events (per rotation), e.g. a ring gear with 160 teeth (N=160).

N+1

Disc type *N* with one additional event, e.g. a disc with 12 teeth and one additional tooth for the index signal (N=12).

N+1 extended index range

Disc type *N* with an additional event, e.g. with one disc with 12 teeth and one additional tooth for the index signal (N=12). The permitted range for the index signal is expanded to 75 % of the tooth period. An incorrect direction of rotation of the engine cannot be detected by this setting.

N-1

Disc type *N*, where one event is missing, e.g. a ring gear with 160 teeth on which one tooth was removed (N=160). This missing event is used to determine the index signal

N-2

Disc type *N*, where two consecutive events are missing, e.g. a ring gear with 60 teeth on which two teeth located next to each other were removed (N=60). This missing event is used to determine the index signal.

N Magnets, Single Magnet

You will always use these two types together for a disc with magnets having opposite polarity. A magnet with a fixed number of magnets (N), all of which are arranged at equal distances on the disc, has a reverse polarity. Thus, the disc supplies two signals that can be analyzed by a pickup.

Single Event

Disc that supplies a single event, e.g., a disc with one tooth or one magnet.

- Number of Events

Enter the number of events that occur on the pickup if more than one event is expected. For the types *N+1* and *N-1*, enter the value for N and not the total number of events. With the type *N Magnets*, the number of magnets with identical polarity must be entered. The number of events must lie between 3 and 500. Additionally, it must be taken into account that the sum of the frequencies at the pickup input does not exceed the limit of 10 kHz at the pre-set overspeed.

- Speed

Select whether the respective pickup will pick up the signal off the camshaft or the crankshaft.

8 Settings via the MICT

- **Active/Passive**
Select the pickup to be used from the pre-defined pick list:
Passive
passive pickup
Active (low)
active pickup with high level as quiescent level
Active (high)
active pickup with low level as quiescent level
- **Pre-Trigger**
Enter a value between 0.1 V and 7.5 V for each pickup to set the pickup sensitivity level. Signals that fall short of the set voltage will not be analyzed. A low pre-set value therefore results in a high sensitivity level, a high value results in a low sensitivity level.



Pickup setup information

The respective latest setting in the area of the pre-defined or arbitrary pickup settings is transferred to and displayed under *Pickup Setup Information*.

Aux. Pickup Supply Voltage

Enter the supply voltage with which the active pickup is to be operated. A value between 5 and 24 V is possible.

Speed Settings

Enter the following settings in this section:

- **Ignition Release**
Enter the release speed for the ignition at which the first ignition is to fire. The value shall not exceed 1/7 of the nominal speed.
- **Security Speed**
Enter the security speed. Below the value entered, the ignition can be switched on and off as desired. If the ignition is deactivated during operation above the set speed, the ignition cannot be immediately reactivated. Only when the ignition no longer reads a speed, i.e., the engine has come to a standstill, can the ignition be reactivated.
- **Nominal Speed**
Enter the nominal speed at which your engine is to be operated. With engines that are to be operated with variable speeds, the max. speed of the operating range must be entered.
- **Overspeed**
Enter the speed at which the ignition is to be shut off as overspeed protection. With engines that are to be operated with variable speeds, a speed above the operating range must be entered.

8 Settings via the MICT

– Max. Power-on Speed

Enter the maximum permitted start speed at which the MIC3+ starts sending ignition pulses. A value of *6000 rpm* is set as the default value: The MIC3+ can be activated at the starter speed and immediately send ignition pulses.

For a value of *0 rpm* the MIC3+ can only start sending ignition pulses once it has registered that the engine is at a standstill.

8.11.6 Timing – Analog Inputs



Auxiliary supply voltage

Check with the configuration of the analog inputs, that the set auxiliary supply voltage corresponds to your application.

8 Settings via the MICT

Analog Inputs Base Settings

The ignition timing adjustment can be made using two analog input signals, which can be set within the following limits:

- Analog current signal: 0-20 mA
- Analog voltage signal: 0-10 V

Set the *Upper Limit* and *Lower Limit* of the signals corresponding to your connected device. Also, you have the option to enter a *Failure Threshold*. If the signal does not reach this value, it is classified by the ignition controller as failure (e.g. wire break). The *error value* configured in the schedule was set for the affected input. To reset the error state, a threshold will need to be exceeded. This threshold value is calculated as follows:

Threshold to reset the error state $\geq 0.5 \times (\text{Lower Limit} - \text{Failure Threshold}) + \text{Failure Threshold}$

You set the analog input that will be used and which timing adjustment results from the analog signal for the two possible schedules. Refer to the section *Timing – Schedule A/B – General* on page 97.

Aux. Analog Input Supply Voltage

An auxiliary supply voltage can be configured for the analog inputs. Enter a voltage value between 5 V and 24 V.

8.11.7 Timing – Schedule A/B – General

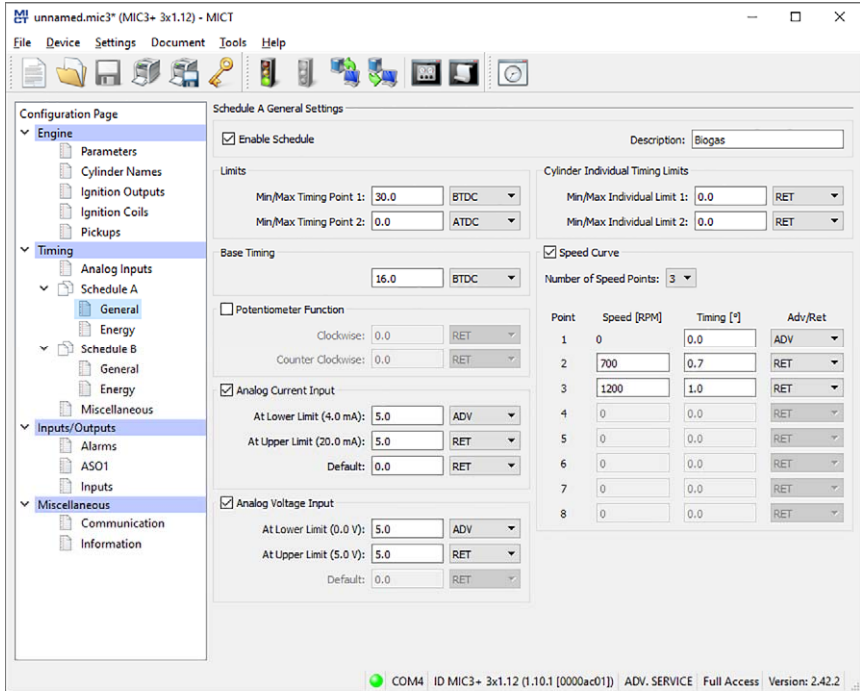

Schedule A General Settings

The MIC3+ offers two schedules for implementing the necessary settings for the timing of the engine. The schedules A and B can be used for dual fuel operation, for example. The system switches between the schedules via the input *Schedule A/B*. If only one schedule is configured, the switch is ignored. The configuration options for schedule B are identical to those for set A.

- **Enable Schedule**
The settings are enabled or disabled by checking/unchecking the box. One schedule must always be activated.
- **Description**
Enter a description for the schedule (e.g. *natural gas* for the setting for this type of gas).

Limits

Enter the limits of the timing point at which the ignition can fire. The timing points of the outputs will be limited to this range relative to the respective top dead center of the pertinent cylinder. The global timing can then not be shifted beyond this range by any adjustments.

■ 8 Settings via the MICT

Base Timing

Enter the timing specified by the engine manufacturer. This point must be within the limits entered and is a static portion of the global timing.

Analog Current Input / Analog Voltage Input

The analog inputs can be enabled and disabled by clicking. If you have the choice, you should prefer the analog current input due to its lower sensitivity to faults.

Enter the values by which the adjustment is to be implemented for the corresponding input signal. An *error value* can be entered for the signals if a *failure threshold* has been defined for the corresponding input in the window *Timing – Analog Inputs*. If the signal is below the failure threshold, the timing is offset by the error value. The adjustment remains until the signal again exceeds the threshold to reset the error state (see *Timing – Analog Inputs* on page 95).

Cylinder Individual Timing Limits

Enter the maximum possible cylinder individual offset. This setting limits, among other things, the adjustment possibility in the window *Cylinder Individual Offset*. In addition the limits also apply to the corresponding adjustment signals from all other sources, for example via the field buses.

Speed Curve

The speed curve can be activated and disabled by mouse click and offsets the timing depending on the speed. A max. of eight speed points are available. If you select a number of points from the list, the corresponding number of fields is activated for input.

The first speed point is always set to 0 RPM. All other timing points are assigned with the value by which the signal is to be offset when the respective speed is reached. For the last speed point, the timing of the nominal speed should be entered. Please note that the speed points must always be entered in ascending order.

8.11.8 Timing – Schedule A/B – Energy

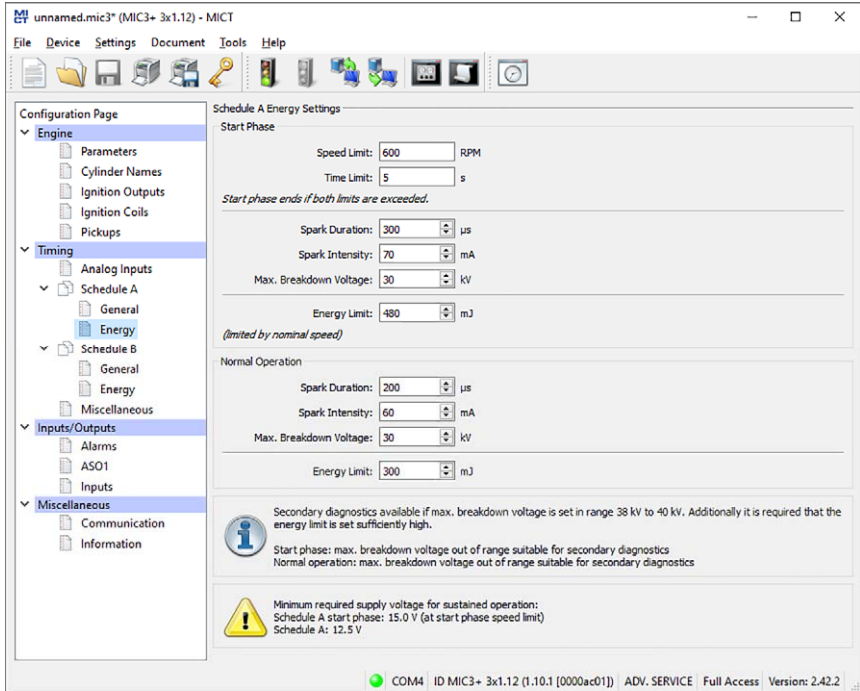

You can make different energy settings for the start phase and normal operation.

Start Phase

Set the start phase of your engine. To do this you can enter a *Speed Limit*, a *Time Limit* or both. If you enter values for both criteria, both values must also be exceeded, so that the ignition controller classifies the start phase as ended and sets the values for normal operation. If you only want to use one criterion, set the other value to 0. If you do not want to define any start-up phase, set both values to 0.

Enter values specific to your application for the *Spark Duration*, the *Spark Intensity* and the *Maximum Breakdown Voltage*. The maximum breakdown voltage corresponds to the maximum voltage expected during operation.

Normal Operation

If the criteria specified for the start phase are exceeded, the settings for normal operation are used by the ignition controller. Make the energy settings the same as for the start phase.

8 Settings via the MICT

Energy Limit

You can use the field *Energy Limit* to limit the output energy made available by the ignition controller. If the set output energy is no longer sufficient to reach the set energy values (spark duration, spark intensity, max. breakdown voltage), the spark duration is reduced correspondingly.



Required supply voltage for energy control

Depending on the output configuration and the energy settings, for a correct energy control, a higher supply voltage than the minimum 10 V DC sufficient for operation of the device can be necessary. If this is the case, the required supply voltage is displayed in a notice in the window *Timing – Schedule A/B – Energy*.

8.11.9 Timing – Miscellaneous

The screenshot displays the MICT software interface for configuring a device. The window title is "unnamed.mic3* (MIC3+ 3x1.12) - MICT". The menu bar includes "File", "Device", "Settings", "Document", "Tools", and "Help". The left sidebar shows a tree view of the configuration structure, with "Timing" expanded to "Miscellaneous". The main area shows the "Miscellaneous" configuration page, specifically the "Max Firing Angle Change Per Cycle" section. This section contains two input fields: "Adv:" with a value of 0.5 and "Ret:" with a value of 0.6. The status bar at the bottom of the window displays "COM4 ID MIC3+ 3x1.12 (1.10.1 [0000ac01]) ADV. SERVICE Full Access Version: 2.42.2".

You can specify how fast the changes of the timing should be executed.

8 Settings via the MICT



– Maximum Firing Angle Change Per Cycle

Specify the maximum degrees per cycle that the ignition timing may be shifted by for both directions, i.e. between two firings of a cylinder. If the specified ignition timing adjustment is larger than the given value, it is divided among several cycles.

8.11.10 Inputs/Outputs – Alarms

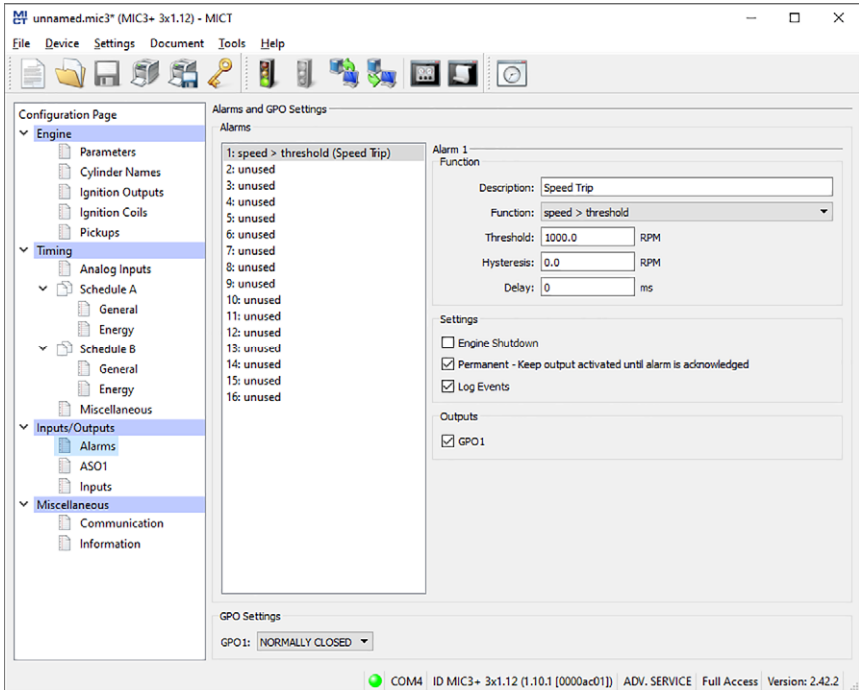

The MIC3+ ignition controllers include a total of 16 configurable alarms that can be allocated to the general purpose outputs.

– Description

You can enter any desired description for an alarm. The description is used for logging the alarms that have occurred in the event list in the MICT.

– Function

The alarms can be used depending on the following functions:

- Unused
- Speed above threshold / below threshold
- Engine operating hours above threshold / below threshold

8 Settings via the MICT

- Spark plug operating hours above threshold / below threshold
- Warning active
- Error active
- Temperature above threshold / below threshold
- Analog voltage input over threshold / under threshold
- Analog current input over threshold / under threshold
- Global ignition timing above the threshold / below the threshold
- Supply voltage above threshold / below threshold
- Min. spark duration above threshold / below threshold
- Misfire rate (primary, single output) over limit
- Misfire rate (primary, all outputs) over limit
- Misfires per second (primary, all outputs) above threshold
- Consecutive misfires (primary, single output) above threshold
- Misfire rate (secondary, individual output) above threshold
- Misfire rate (secondary, all outputs) above threshold
- Misfires per second (secondary, all outputs) above threshold
- Consecutive misfires (secondary, single output) over the limit
- **Threshold**
Input of desired threshold value.
- **Hysteresis**
Input of desired hysteresis value.
- **Delay**
Input of desired delay. The threshold value defined in the alarm must have been exceeded or not reached for a longer period than the specified time for an alarm to be triggered. If a corresponding value occurs for a shorter period of time, no alarm is triggered.
- **Engine Shutdown**
If this checkbox is checked, the ignition is switched off as soon as the alarm is triggered. The shutdown causes an operational error. Therefore the checkbox should not be checked, if the alarm *Error active* is selected.
- **Permanent – Keep output activated until alarm is acknowledged**
If this box is checked, the output remains permanently active until the alarm is acknowledged. If the box is not checked, the output remains active only for as long as the alarm is active.
- **Log Events**
If this box is checked, the event list records when the alarm occurred or when it was acknowledged.

8 Settings via the MICT



– Outputs

Activate the checkbox *GPO1*, so that the general purpose output is activated when the alarm is triggered.

– GPO Settings

Configure the general purpose output as normally closed or normally open.

8.11.11 Inputs/Outputs – ASO1 (Auxiliary Synchronization Output)

Configuration Page

- Engine
 - Parameters
 - Cylinder Names
 - Ignition Outputs
 - Ignition Coils
 - Pickups
- Timing
 - Analog Inputs
 - Schedule A
 - General
 - Energy
 - Schedule B
 - General
 - Energy
 - Miscellaneous
- Inputs/Outputs
 - Alarms
 - ASO1
 - Inputs
- Miscellaneous
 - Communication
 - Information

ASO1

Number of Points: 1

Angle Reference: Actual Angles Depending on Global Timing

Mode: Trailing Rising Edge (default)

Point	Angle [°]	Pulse Width [µs]
1	0.0	200
2	0.0	10
3	0.0	10
4	0.0	10
5	0.0	10
6	0.0	10

Point	Angle [°]	Pulse Width [µs]
7	0.0	10
8	0.0	10
9	0.0	10
10	0.0	10
11	0.0	10
12	0.0	10

Configure for DetCon2/20

COM4 | ID MIC3+ 3x1.12 (1.10.1 [0000ac01]) | ADV. SERVICE | Full Access | Version: 2.42.2

With the auxiliary synchronization output, freely definable impulses depending on the angle of the crankshaft can be generated. For the output, the user defines whether the angle will be absolute or based on the global timing. The output can generate between 1 and 12 impulses and only be assigned to one system at a time. One example of the application of the ASO output for a detonation controller can be found in section *ASO: Auxiliary Synchronization Output* on page 61.

– No. of Points

Select the number of impulses from the *No. of Points* list. Please note that the DetCon detonation controller devices require a single impulse with 200 µs synchronous with the first cylinder in the ignition sequence. You can get this setting via the button *Configure for DetCon2/20*.

8 Settings via the MICT

– Angle Reference

Select from the *Angle Reference* drop-down list whether the angle shall be based on the absolute angle of the crankshaft or the actual angle depending on global timing. Then, enter the trigger angle for each impulse and the length of the impulse in μs . This setting also determines when ASO signals are generated. For this, also read the information box *ASO signals depending on the ignition release*.

– Mode

Select the mode for the ASO signal.

In the default setting *Trailing Rising Edge (default)*, the signal is low-active.

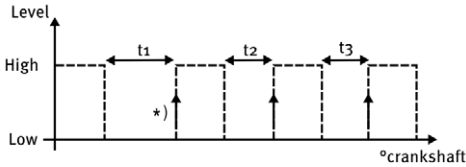

In the setting *Trailing Falling Edge (inverted)*, the signal is high-active.

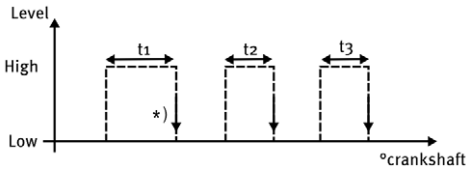

*) active edge marks the configured engine rotation angle



Maximum impulse duration

Please note that the duration of the impulse can be entered as max. 300 μs . Input of higher values will not be accepted by the system.



ASO signals depending on the ignition release

The setting in the drop down list *Angle Reference* determines when ASO signals are generated:

- [Actual Angles Depending on Global Timing](#)
ASO pulses are only transmitted if ignition is active, indicated by the green status display *Firing Active* in the window *Runtime Data – Overview*.
- [Absolute Timing](#)
ASO pulses are generated independently of the ignition release as soon as the synchronization of the pickups is accomplished.

8.11.12 Inputs/Outputs – Inputs

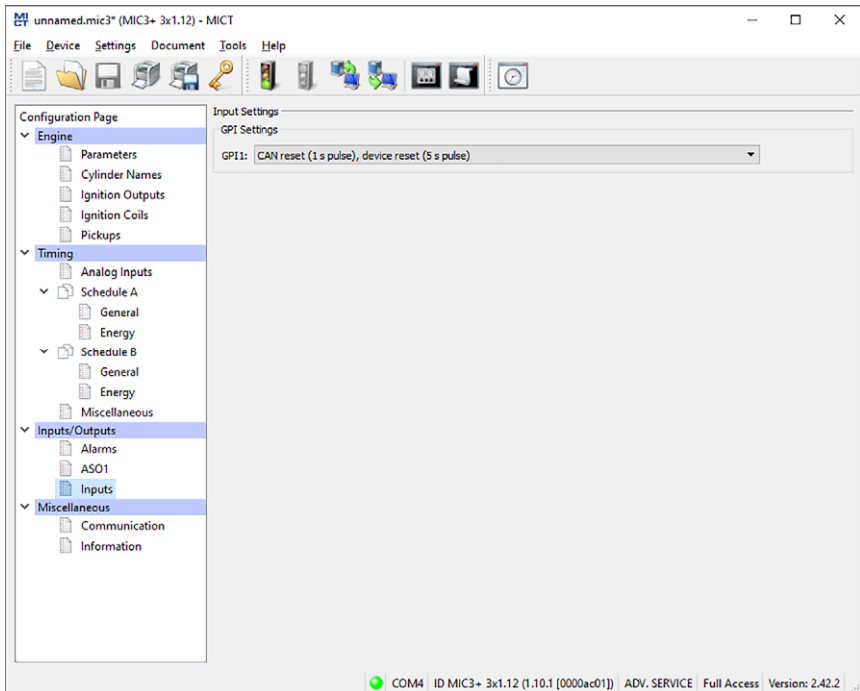

Various functions can be selected for the general purpose input GPI1:

- [Disabled](#)
The input GPI1 will not be used.

8 Settings via the MICT

- **CAN reset (1 s pulse), device reset (5 s pulse)**
This feature allows (e.g. a master control) to trigger a CAN reset and/or a device reset externally using a high impulse. A high impulse of 1 second leads to a reset of the CAN driver and a high impulse of 5 seconds leads to a device reset.
- **Warning acknowledge (< 3 s high), error and alarm acknowledge (> 3 s high), device reset (> 15 s high)**
This feature allows (e.g. a master control) warnings, errors, and alarms to be confirmed and/or device reset to be triggered externally using a high impulse. If the high impulse is shorter than 3 seconds, all warnings will be confirmed. If the high impulse is longer than 3 seconds, all errors and alarms will be confirmed. If the high level lasts for more than 15 seconds, this triggers a device reset.

8.11.13 Miscellaneous – Communication

The screenshot displays the MICT software interface for configuring a MIC3+ 3x1.12 device. The window title is "unnamed.mic3* (MIC3+ 3x1.12) - MICT". The interface includes a menu bar (File, Device, Settings, Document, Tools, Help) and a toolbar with various icons. On the left, a "Configuration Page" tree shows the following structure:

- Engine
 - Parameters
 - Cylinder Names
 - Ignition Outputs
 - Ignition Coils
 - Pickups
- Timing
 - Analog Inputs
 - Schedule A
 - General
 - Energy
 - Schedule B
 - General
 - Energy
 - Miscellaneous
- Inputs/Outputs
 - Alarms
 - ASO1
 - Inputs
- Miscellaneous
 - Communication (selected)
 - Information

The main area shows the "Communication" settings:

- CAN**
 - CAN Mode**
 - ALL-IN-ONE (J1939)
 - J1939
 - CANopen
 - CANopen Settings**
 - CANopen Node ID: 30
 - Bitrate: 250 kbit/s
- RS485**
 - RS485 Mode**
 - Modbus
 - RS485 Settings**
 - Bitrate: 9600 bit/s
 - Parity: even
 - Stop Bits: 1
 - Modbus Settings**
 - Modbus Address: 1
 - Mode: rtu

The status bar at the bottom indicates: COM4 | ID MIC3+ 3x1.12 (1.10.1 [0000ac01]) | ADV. SERVICE | Full Access | Version: 2.42.2

8 Settings via the MICT



CAN

Clicking on the *CAN* checkbox enables or disables the CAN interface on the device.

- **ALL-IN-ONE (J1939)/J1939/CANopen**
Select the desired protocol, depending on whether you want to set the communication for the ALL-IN-ONE or for another device. For example, for a connection to the PowerView3, select CANopen.
- **J1939 Settings**
The J1939 source address can be assigned between 0 and 253. Note that IDs cannot be assigned more than once. The *Address Filter* can be used to set that broadcast PGNs are only accepted from one or two specific source addresses you have entered. If the filter is deactivated, the broadcast PGNs are accepted from all source addresses.
- **CANopen Settings**
The CANopen node ID can be assigned between 1 and 127. Note that IDs cannot be assigned more than once.
- **Baudrate**
Select the desired data transfer rate from the list. The baud rate can be defined between 50 kbit/s and 1 Mbit/s, the recommended value being 250 kbit/s.

RS485

Clicking on the field *RS485* enables or disables the Modbus interface on the device.

- **Baudrate**
Select the desired data transfer rate from the list. The Modbus baud rate can be defined between 9,600 bit/s and 115,200 bit/s, the recommended value being 19,200 bit/s.
- **Parity**
Define if a parity bit is used and if the parity is to be even or odd.
- **Stopbits**
Determine if one or two stop bits are to be sent. Two stop bits can only be sent if no parity has been selected.
- **Modbus Address**
The Modbus address can be assigned between 1 and 247. Note that IDs cannot be assigned more than once.
- **Mode**
Define if the data are transferred in the ASCII or RTU mode.



Setting the transfer rate

Please note that all devices connected with a bus must be set to the same transfer rate.

8 Settings via the MICT



Information on protocols

Please contact your MOTORTECH contact person if you require more information on the CANopen®, J1939 and Modbus protocols.

8.11.14 Miscellaneous – Information

This configuration page can be viewed by all users, but changes can only be made with authorization for the *Service* access level.

Site and Module

In this section, enter information on the system and the module for which the configuration will be used.

Service Contact

In this section, individual contact data can be saved that can be called up and displayed via MICT.

8.12 Runtime Data



Click on the symbol to open the window *Runtime Data*. The following sections will give you an overview of the data you can view on the individual tabs.

You can print and record the runtime data. For this purpose, the following functions are at your disposal in the toolbar in the window:

Symbol	Function
	Prints the runtime data.
	Prints the runtime data to a PDF file.
	Opens the print preview.
	Starts the runtime data trace.
	Stops the runtime data trace.
	Acknowledges the operating errors. If an operating error is acknowledged, all alarms are also simultaneously acknowledged. The symbol is grayed out if no acknowledged error is present.



Save runtime data locally

You should always save runtime data on the local computer and not on a network drive or external storage device. Trace files can only be moved freely once the recording is stopped.

8 Settings via the MICT

8.12.1 Runtime Data – Overview

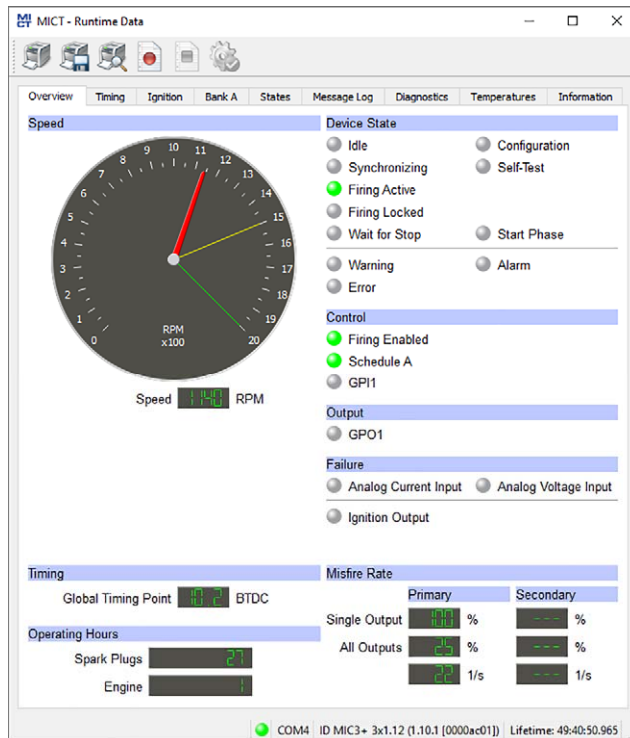

In this screen, you can find the following information:

- **Speed Indicator (analog)**
 - Red pointer
Displays the current registered speed
 - Yellow pointer
Displays the maximum registered speed since last starting the engine
 - Green pointer
Display of set overspeed
- **Speed Indicator (digital)**
Digitally displays the current speed
- **Global Timing Point**
Digital indication of the current global timing

8 Settings via the MICT



- **Operating Hours**
 - **Spark Plugs**
Indicates the current operating hours of the spark plugs
 - **Engine**
Indication of current operating hours of the engine
- **Device State**
The status of the device is shown by the following status displays:

Device status	Description
Idle	The ignition is ready and waiting for pickup activity.
Synchronizing	Pickup signals are being received and analyzed.
Firing Active	The ignition is active.
Firing Locked	Pickup signals are being received and are valid, ignition is not released.
Wait for Stop	Pickup signals are being received, the ignition fired above the security speed, and the ignition release was retracted. The engine must now come to a standstill.
Configuration	The device is being configured.
Self Test	The self test is running (refer to <i>Self Test</i> on page 72).
Start Phase	The engine is in the configured start phase (refer to section <i>Timing – Schedule A/B – Energy</i> on page 99).
Warning	A warning has occurred (refer to <i>Warnings</i> on page 127).
Error	An error has occurred (refer to <i>Failure</i> on page 129).
Alarm	A configured alarm has occurred (refer to <i>Alarms</i> on page 128).

- **Control**
 - **Firing Enabled**
The green status display signals that the firing is active.
 - **Schedule A/B**
The green status display shows which parameter settings are currently used.
 - **GPI₁**
The status display shows the status of the input signal.
- **Output**
 - **GPO₁**
The general purpose output is switched on with the green status display.

8 Settings via the MICT

- **Failure**
 - **Analog Current Input**

The red status display signals that the set failure threshold for the input has been reached. If the lower limit of the signal is reached again, the status display is again gray.
 - **Analog Voltage Input**

The red status display signals that the set failure threshold for the input has been reached. If the lower limit of the signal is reached again, the status display is again gray.
 - **Ignition Output**

The red status display signals a current misfire on at least one output. With a yellow status display at least one misfire has occurred at one output since the last reset of the counter.
- **Misfire Rate**

The misfire rate is displayed for the primary side and secondary side. The misfire rate on the secondary side is only displayed if the secondary side diagnosis is activated (refer to section *Engine – Ignition Coils* on page 89).

 - **Single Output**

Displays the misfire rate of the output for which the most misfires were registered during the last 32 cycles.
 - **All Outputs**

Displays the misfire rate for all the ignition outputs for the past 32 cycles.
 - The number of misfires per second are calculated by the MIC3+ as follows:
 - 2-stroke engine: $\text{Number of currently misfiring outputs} \times \text{RPM} / 60$
 - 4-stroke engine: $\text{Number of currently misfiring outputs} \times \text{RPM} / 60 / 2$

8.12.2 Runtime Data – Timing

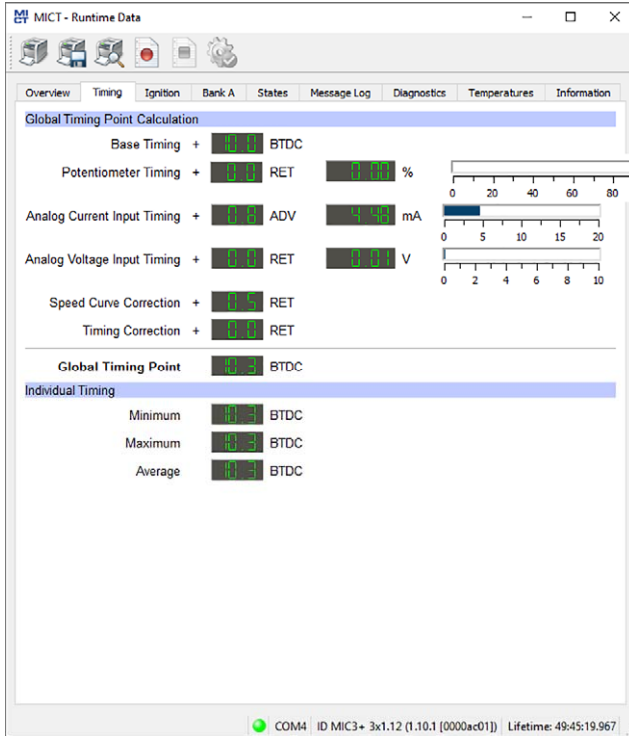

In this view, the system displays all values and settings in the left hand section that influence the timing. On the right, the current input values (e. g. potentiometer, analog current and voltage input), leading to the displayed timing adjustment, are displayed numerically and in bar charts. The value for the speed curve is shown by curve progression set in the configuration. Refer to the section *Timing – Schedule A/B – General* on page 97. The timing correction can be implemented for the runtime. Refer to the section *Runtime Adjustments – Timing* on page 140.

In the lower range, the maximum, minimum and average of the cylinder individual offsets are also displayed.

8 Settings via the MICT

8.12.3 Runtime Data – Ignition

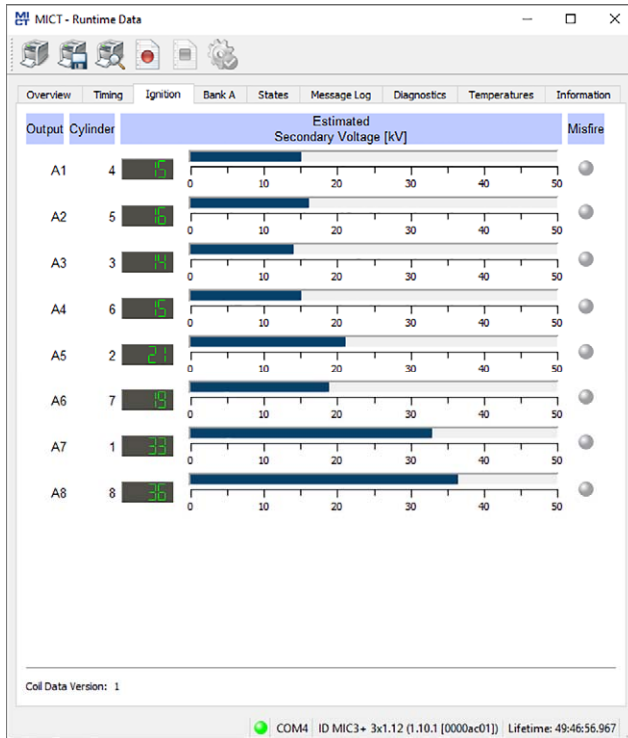

The following information is provided:

- Column: **Output**
Designation of the output
- Column: **Cylinder**
If cylinder names are assigned, these are displayed.
- Column: **Estimated Secondary Voltage [kV]**
Secondary voltage determined by the ignition controller of the respective output. The secondary voltage is used to determine deviations between the individual outputs. These indicate a possible problem at this output (e. g. problems in the area of the spark plug or the cylinder).
If you have set the ignition coils (refer to *Engine – Ignition Coils* on page 89) for which a secondary voltage estimate does not seem possible "---" appears.

8 Settings via the MICT



- Column: **Misfire**

The red status display signals a current misfire at the respective output. With a yellow status display at least one misfire has occurred at the respective output since the last reset of the counter.

The coil data version configured in the MIC3+ is displayed under the ignition runtime data.

8.12.4 Runtime Data – Bank A

Output	Cylinder	Angle [° Crank]	Min. Spark Duration [µs]	Energy Output [mJ]	Misfire					
					Primary			Secondary		
					open	short	Rate [%]	open	short	Rate [%]
A1	5	9.8	202.1	151	●	●	0	●	●	0
A2	4	92.8	202.1	151	●	●	0	●	●	0
A3	6	108.8	202.1	151	●	●	0	●	●	0
A4	3	159.8	202.1	151	●	●	0	●	●	0
A5	7	163.8	202.1	151	●	●	0	●	●	0
A6	2	253.8	202.1	151	●	●	0	●	●	0
A7	8	268.8	202.1	151	●	●	0	●	●	0
A8	1	309.8	202.0	148	●	●	0	●	●	0

Show Firing Angles: Relative Absolute

COM4 | ID MIC3+ 3x1.12 (1.10.1 [0000ac01]) | Lifetime: 50:03:52.975

The following information is provided:

- Column: **Output**
Designation of the output
- Column: **Cylinder**
If cylinder names are assigned, these are displayed.
- Column: **Angle**
Current output firing angle

■ 8 Settings via the MICT

- Column: **Min. Spark Duration**
Minimum spark duration of the outputs
- Column: **Energy Output**
Current energy release of the output
- Columns: **Misfire**
Status display for the different types of misfires (primary, secondary, open, short circuit). In case of misfire, the respective status display turns red, otherwise it is gray. With a yellow status display misfires have occurred since the last reset of the counter.
If you hold the pointer over the status display, an overview of the misfire counter of the respective output is displayed for all types of misfires. A maximum up to 255 is counted per type of misfire. The counter manually resets using the menu item *Device-> Send command -> Reset misfire counters*. When starting the engine and starting the self test the counters are automatically reset.

You have the following options:

- **Relative/Absolute**
Select via the option, whether the firing angle should be displayed absolute or relative.

8 Settings via the MICT



8.12.5 Runtime Data – States

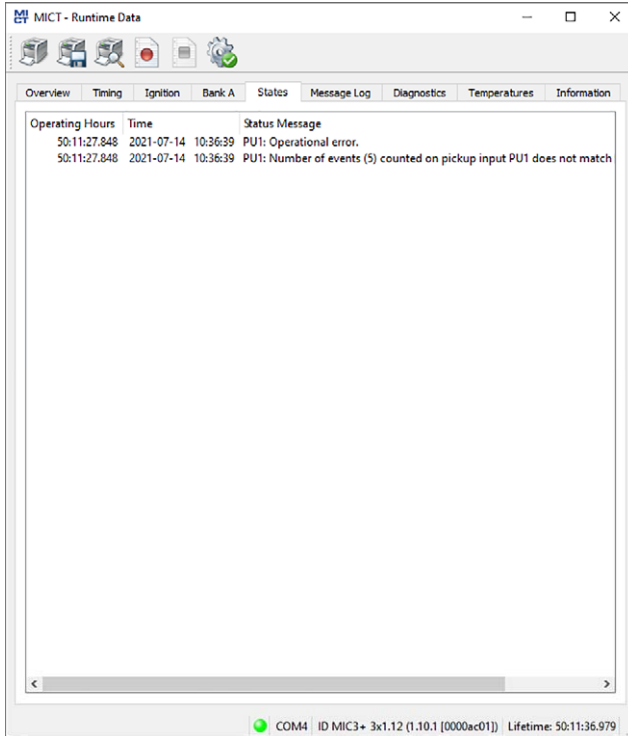

Status messages are listed in the *States* view.

The following information is provided:

- **Operating Hours**
Operating hours counter reading at the time of message
- **Time**
Date and time of the message (see following information box)
- **Status Message**
Message text

8 Settings via the MICT



Date and time of ignition controller

The date and time can be individually configured for each ignition controller and saved in the device. The device does not adjust automatically for daylight savings time. Hence, deviations may occur between the device time and the time on the computer used to access the device.

Correspondingly, the times indicated for the states, messages, and in the log reflect the time of the ignition controller. The current time of the ignition controller is shown in the view *Runtime Data – Information*. You can adjust the time of the ignition controller by entering the desired time in the menu via *Device -> Set date and time*.

Status messages are displayed in black if they are current. If a status is reset, the status message is displayed gray for 10 seconds before it is deleted from the list.

The following status messages can be displayed:

Status message	Description
Alarm shutdown caused by alarm <i>number</i> .	The engine was shut down by an alarm, as the configured limit was exceeded or not reached. You can view the alarm <i>number</i> in the configuration (see <i>Inputs/Outputs – Alarms</i> on page 101).
Analog current input failure (current: <i>x mA</i> , failure threshold: <i>y mA</i> , failure reset threshold: <i>z mA</i>).	Failure threshold set for analog current input was undershot (see <i>Timing – Analog Inputs</i> on page 95). The following values were obtained: Current: <i>x mA</i> , failure threshold: <i>y mA</i> , threshold for failure reset: <i>z mA</i> .
Analog voltage input failure (voltage: <i>x V</i> , failure threshold: <i>y V</i> , failure reset threshold: <i>z V</i>).	Failure threshold set for analog voltage input was undershot (see <i>Timing – Analog Inputs</i> on page 95). The following values were obtained: Voltage: <i>x V</i> , failure threshold: <i>y V</i> , threshold for failure reset: <i>z V</i> .
Aux analog input supply voltage failure (voltage: <i>u V</i> , desired voltage: <i>v V</i> , failure threshold: <i>x V</i> , failure reset threshold: <i>y V</i>).	Error in auxiliary supply voltage of analog inputs (see <i>Timing – Analog Inputs</i> on page 95). The following values were obtained: Voltage: <i>u V</i> , expected voltage: <i>v V</i> , failure threshold: <i>x V</i> , threshold for failure reset: <i>y V</i> .
Aux pickup supply voltage failure (voltage: <i>u V</i> , desired voltage: <i>v V</i> , failure threshold: <i>x V</i> , failure reset threshold: <i>y V</i>).	Error in auxiliary supply voltage of pickup (see <i>Engine – Pickups</i> on page 91). The following values were obtained: Voltage: <i>u V</i> , expected voltage: <i>v V</i> , failure threshold: <i>x V</i> , threshold for failure reset: <i>y V</i> .
Configuration data checksum error. Using default configuration.	The checksum of the configuration data is faulty. The default configuration is used. This message may appear during an upgrade/downgrade. Check your configuration data and the MICT version being used. Then download the configuration to the device once again.

8 Settings via the MICT



Status message	Description
Configuration invalid. Using previous configuration.	The configuration is invalid. The previous configuration is used. This message may appear during an upgrade/downgrade. Check your configuration data and the MICT version being used. Then download the configuration to the device once again.
Current sensor of output bank <i>name</i> failed.	The current sensor of output bank <i>name</i> failed. Restart the ignition controller. If the error occurs again after restarting the device, please contact MOTORTECH.
Cylinder individual timing limited to range <i>timing 1</i> .. <i>timing 2</i>	The cylinder-individual offset has reached the set limit (<i>Timing 1</i> ... <i>Timing 2</i> (see <i>Timing – Schedule A/B – General</i> on page 97).
Device started after supply voltage failure.	The device was started after a failure of the supply voltage. Please check the power supply of the device where applicable.
General error <i>number</i> .	General error <i>number</i> . Restart the ignition controller. If the error occurs again after restarting the device, please contact MOTORTECH.
Global timing <i>x</i> ^o <i>crankshaft</i> limited to range <i>y</i> ^o <i>crankshaft</i> .. <i>z</i> ^o <i>crankshaft</i> .	The global timing (<i>x</i> ^o <i>crankshaft</i>) is located outside the configured limits (<i>y</i> ^o <i>crankshaft</i> .. <i>z</i> ^o <i>crankshaft</i> ; see <i>Timing – Schedule A/B – General</i> on page 97).
Incompatible coil parameters received, secondary voltage diagnostics disabled.	Incompatible coil parameters received. The secondary voltage diagnostics have been disabled. This message may appear during an upgrade/downgrade. Check your configuration data and the MICT version being used. Then download the configuration to the device once again.
Output board identification failed due to a checksum error.	The identification of the output board failed due to a checksum error. Restart the ignition controller. If the error occurs again after restarting the device, please contact MOTORTECH.
Output board identification failed due to incompatible hardware.	The identification of the output board failed due to incompatible hardware. Restart the ignition controller. If the error occurs again after restarting the device, please contact MOTORTECH.
Output board identification failed due to missing data.	The identification of the output board failed due to missing data. Restart the ignition controller. If the error occurs again after restarting the device, please contact MOTORTECH.

8 Settings via the MICT

Status message	Description
Output board identification failed due to unknown error <i>number</i> .	The identification of the output board failed due to unknown error <i>number</i> . Characteristic data of the output board could not be read, they are defective or do not match the device. Restart the ignition controller. If the error occurs again after restarting the device, please contact MOTORTECH.
Output board identification failed due to unknown hardware.	The identification of the output board failed due to unknown hardware. Characteristic data of the output board could not be read, they are defective or do not match the device. Restart the ignition controller. If the error occurs again after restarting the device, please contact MOTORTECH.
Pickup configuration invalid.	The pickup configuration is invalid. This message may appear during an upgrade/downgrade. Check your configuration data and the MICT version being used. Then download the configuration to the device once again.
Power failure detected on output <i>Anumber</i> .	Power supply fault in output board at output <i>Anumber</i> was detected. Restart the ignition controller. If the error occurs again after restarting the device, please contact MOTORTECH.
Power output (<i>x W</i>) exceeded error threshold limit (<i>y W</i>) at a supply voltage of <i>z V</i> .	The power output (<i>x W</i>) exceeded failure threshold (<i>y W</i>) at a supply voltage of <i>z V</i> . Increase the supply voltage and check the energy settings (see <i>Timing – Schedule A/B – Energy</i> on page 99).
Power output (<i>x W</i>) exceeded limit (<i>y W</i>) at a supply voltage of <i>z V</i> .	The power output (<i>x W</i>) exceeded warning threshold limit (<i>y W</i>) for longer than two minutes at a supply voltage of <i>z V</i> . Increase the supply voltage and check the energy settings (see <i>Timing – Schedule A/B – Energy</i> on page 99).
The power output (<i>x W</i>) exceeded permanent limit (<i>y W</i>) at a supply voltage of <i>z V</i> .	The power output (<i>x W</i>) exceeded warning threshold limit (<i>y W</i>) for longer than three minutes at a supply voltage of <i>z V</i> . Increase the supply voltage and check the energy settings (see <i>Timing – Schedule A/B – Energy</i> on page 99).
P <i>U</i> number: Faulty index.	The pickup P <i>U</i> number has an error in index. Check the pickups and the corresponding configuration (see <i>Engine – Pickups</i> on page 91). Furthermore, also pay attention to the instructions in the section entitled <i>Pickup Input Errors</i> on page 158.

Status message	Description
<p>PUnumber: Faulty Signal. Signal period (x, events counted y) is too small compared to previous signal period (z).</p>	<p>The pickup (PUnumber) is supplying a faulty signal. Signal period (x, events counted y) is too small compared to previous signal period (z). Check the pickups and the corresponding configuration (see <i>Engine – Pickups</i> on page 91). Furthermore, also pay attention to the instructions in the section entitled <i>Pickup Input Errors</i> on page 158.</p>
<p>PUnumber: Index mark missing.</p>	<p>Index mark missing for pickup (PUnumber). Check the pickups and the corresponding configuration (see <i>Engine – Pickups</i> on page 91). Furthermore, also pay attention to the instructions in the section entitled <i>Pickup Input Errors</i> on page 158.</p>
<p>PUnumber: Missing index.</p>	<p>Index missing for pickup (PUnumber). Check the pickups and the corresponding configuration (see <i>Engine – Pickups</i> on page 91). Furthermore, also pay attention to the instructions in the section entitled <i>Pickup Input Errors</i> on page 158.</p>
<p>PUnumber: Missing Signal. Signal period (x, events counted y) is too great compared to previous signal period (z).</p>	<p>Signal missing for pickup (PUnumber). Signal period (x, events counted y) is too large compared to previous signal period (z). Check the pickups and the corresponding configuration (see <i>Engine – Pickups</i> on page 91). Furthermore, also pay attention to the instructions in the section entitled <i>Pickup Input Errors</i> on page 158.</p>
<p>PUnumber: Missing Signal. Signal timeout occurred (events counted x).</p>	<p>Signal missing for pickup (PUnumber). Timeout occurred (events counted until timeout x). Check the pickups and the corresponding configuration (see <i>Engine – Pickups</i> on page 91). Furthermore, also pay attention to the instructions in the section entitled <i>Pickup Input Errors</i> on page 158.</p>
<p>PUnumber: No index mark found.</p>	<p>Could not find index mark for pickup (PUnumber). Check the pickups and the corresponding configuration (see <i>Engine – Pickups</i> on page 91). Furthermore, also pay attention to the instructions in the section entitled <i>Pickup Input Errors</i> on page 158.</p>
<p>PUnumber: No signal.</p>	<p>The pickup (PUnumber) is not supplying a signal. Check the pickups and the corresponding configuration (see <i>Engine – Pickups</i> on page 91). Furthermore, also pay attention to the instructions in the section entitled <i>Pickup Input Errors</i> on page 158.</p>

8 Settings via the MICT

Status message	Description
PNumber: Number of events (x) counted on pickup input PNumber does not match the expected value (y).	For the pickup (PNumber) the number of events (x) counted on pickup input number does not match the expected value (y). Check the pickups and the corresponding configuration (see <i>Engine – Pickups</i> on page 91). Furthermore, also pay attention to the instructions in the section entitled <i>Pickup Input Errors</i> on page 158.
PNumber: Operational error.	An operational error occurred at pickup (PNumber). Check the pickups and the corresponding configuration (see <i>Engine – Pickups</i> on page 91). Furthermore, also pay attention to the instructions in the section entitled <i>Pickup Input Errors</i> on page 158.
PNumber: Polarity detection failed.	Polarity detection failed for pickup (PNumber). Check the pickups and the corresponding configuration (see <i>Engine – Pickups</i> on page 91). Furthermore, also pay attention to the instructions in the section entitled <i>Pickup Input Errors</i> on page 158.
PNumber: Synchronization problem.	A synchronization error occurred at pickup (PNumber). Check the pickups and the corresponding configuration (see <i>Engine – Pickups</i> on page 91). Furthermore, also pay attention to the instructions in the section entitled <i>Pickup Input Errors</i> on page 158.
PNumber: Wrong pickup signal polarity on pickup input PNumber detected. Reversing polarity internally.	Wrong polarity of pickup (PNumber) detected at pickup input PNumber . Reversing polarity internally. No additional action required.
Self test aborted because pickup signals have been detected on pickup input PNumber .	Self test aborted because pickup signals have been detected on pickup input PNumber . Self test can only be carried out when engine is at a standstill (see <i>Self Test</i> on page 72). Potential causes: <ul style="list-style-type: none">– Interference coupling on pickup signal– Engine was started
Speed (x RPM) exceeded overspeed limit (y RPM) at trigger signal number .	The speed (x RPM) exceeded overspeed limit (y RPM) at trigger signal number (see <i>Engine – Pickups</i> on page 91). The reason for this may also be an interference coupling on the trigger signal.
Temperature of device (x °C) exceeded error threshold limit (y °C).	The temperature of the device (x °C) exceeded failure threshold (y °C). Ensure that there is sufficient air circulation and/or cooling.

8 Settings via the MICT

Status message	Description
Temperature of device ($x^{\circ}\text{C}$) exceeded limit ($y^{\circ}\text{C}$).	The temperature of the device ($x^{\circ}\text{C}$) exceeded warning threshold limit ($y^{\circ}\text{C}$) for more than two minutes. Ensure that there is sufficient air circulation and/or cooling.
Temperature of device ($x^{\circ}\text{C}$) exceeded permanent limit ($y^{\circ}\text{C}$).	The temperature of the device ($x^{\circ}\text{C}$) exceeded warning threshold limit ($y^{\circ}\text{C}$) for more than ten minutes. Ensure that there is sufficient air circulation and/or cooling.
Temperature sensor failed.	The temperature sensor has failed. Restart the ignition controller. If the error occurs again after restarting the device, please contact MOTORTECH.

8.12.6 Runtime Data – Message Log

The screenshot shows the 'Message Log' tab in the MICT software. The log is organized into columns: Operating Hours, Time, Category, and Message. The messages include status changes, device switching, and error reports.

Operating Hours	Time	Category	Message
43:51:27.974	2021-07-06 09:10:50	Info	J1939 on interface CAN1 changed state to "Enter".
43:51:28.234	2021-07-06 09:10:51	Info	J1939 on interface CAN1 changed state to "Start succeeded Configuration changed.
43:56:03.915	2021-07-06 09:15:26	Info	All alarms reset.
43:56:03.916	2021-07-06 09:15:26	Alarm	All alarms reset.
44:41:41.210	2021-07-06 10:01:04	Info	Device switched off.
44:41:42.473	2021-07-06 10:33:10	Info	Device (firmware 1.12.0.40630) started at a supply voltage o
44:41:42.474	2021-07-06 10:33:10	Info	J1939 on interface CAN1 changed state to "Enter".
44:41:42.734	2021-07-06 10:33:10	Info	J1939 on interface CAN1 changed state to "Start succeeded
46:22:38.642	2021-07-06 12:14:07	Info	Device switched off.
46:22:39.905	2021-07-07 08:45:08	Info	Device (firmware 1.12.0.40630) started at a supply voltage o
46:22:39.906	2021-07-07 08:45:08	Info	J1939 on interface CAN1 changed state to "Enter".
46:22:40.166	2021-07-07 08:45:08	Info	J1939 on interface CAN1 changed state to "Start succeeded
46:40:10.416	2021-07-07 09:02:38	Info	Device switched off.
46:40:11.679	2021-07-07 09:34:29	Info	Device (firmware 1.12.0.40630) started at a supply voltage o
46:40:11.680	2021-07-07 09:34:29	Info	J1939 on interface CAN1 changed state to "Enter".
46:40:11.940	2021-07-07 09:34:29	Info	J1939 on interface CAN1 changed state to "Start succeeded
47:37:20.339	2021-07-07 10:31:38	Info	Device switched off.
47:37:21.602	2021-07-13 10:10:32	Info	Device (firmware 1.12.0.40630) started at a supply voltage o
47:37:21.603	2021-07-13 10:10:32	Info	J1939 on interface CAN1 changed state to "Enter".
47:37:21.863	2021-07-13 10:10:32	Info	J1939 on interface CAN1 changed state to "Start succeeded
49:11:15.930	2021-07-13 11:44:27	Info	Self test started.
49:11:39.794	2021-07-13 11:44:50	Info	Self test stopped.
49:35:45.848	2021-07-13 12:08:57	Info	Device switched off.
49:35:47.112	2021-07-14 10:00:58	Info	Device (firmware 1.12.0.40630) started at a supply voltage o
49:35:47.112	2021-07-14 10:00:58	Info	J1939 on interface CAN1 changed state to "Enter".
49:35:47.373	2021-07-14 10:00:58	Info	J1939 on interface CAN1 changed state to "Start succeeded
50:09:54.525	2021-07-14 10:35:06	Info	Firing disabled (Start/Stop In: disabled, CAN: n/a, RS485: n/
50:09:55.029	2021-07-14 10:35:06	Info	Firing enabled (Start/Stop In: enabled, CAN: n/a, RS485: n/a
50:11:27.848	2021-07-14 10:36:39	Error	General error in pickup pre-processing on pickup input PU
50:11:27.848	2021-07-14 10:36:39	Error	Operational error caused by pickup signals. PU1 = 0x00010
50:12:48.254	2021-07-14 10:37:59	Info	Operational error acknowledged.

At the bottom of the window, there is a status bar showing: COM4 | ID MIC3+ 3x1.12 (1.10.1 [0000ac01]) | Lifetime: 50:12:59.979

In the view *Message Log*, information, warnings, errors and alarms are listed.

8 Settings via the MICT

Information, warnings and errors are specified by the ignition controller, while alarms can be freely configured using the MICT. Refer to the section *Inputs/Outputs – Alarms* on page 101.

Errors and appropriately configured alarms shut down the engine.

The following information is provided:

- **Operating Hours**
Operating hours counter reading at the time of message
- **Time**
Date and time of the message (see following information box)
- **Category**
Type of message (information, warning, error, alarm)
- **Message**
Message text; you can find more information on the message text in the following sections.

You have the following options:

- **Automatic scrolling**
If this box is checked, the system automatically displays the last list entry until a new event occurs.
- **Acknowledge Alarms**
With this button, you can reset triggered alarms if they are no longer active. An alarm can only be acknowledged if the checkbox *Permanent – Keep output activated until alarm is acknowledged* in the alarm configuration is activated.



Date and time of ignition controller

The date and time can be individually configured for each ignition controller and saved in the device. The device does not adjust automatically for daylight savings time. Hence, deviations may occur between the device time and the time on the computer used to access the device.

Correspondingly, the times indicated for the states, messages, and in the log reflect the time of the ignition controller. The current time of the ignition controller is shown in the view *Runtime Data – Information*. You can adjust the time of the ignition controller by entering the desired time in the menu via *Device -> Set date and time*.



Acknowledging an operating error

While the engine is in standstill, there are the following options for acknowledging operating errors:

- via *Device* -> *Send command* -> *Acknowledge operational error* in the MICT
- Restart / Reset

8.12.6.1 Information

Information	Description
Access control disabled.	The Access control was disabled (see <i>Access Control for MIC3+</i> on page 76).
Access control enabled.	The Access control was enabled (see <i>Access Control for MIC3+</i> on page 76).
All access control PINs reset.	All PINs for access control were reset (see <i>Access Control for MIC3+</i> on page 76).
CAN interface <i>CANnumber</i> entered bus off state.	The CAN interface <i>CANnumber</i> has entered <i>Bus off</i> state (see <i>Runtime Data – Diagnostics</i> on page 133).
CAN interface <i>CANnumber</i> left bus off state.	The CAN interface <i>CANnumber</i> has left the <i>Bus off</i> state (see <i>Runtime Data – Diagnostics</i> on page 133).
CAN reset requested by <i>GPInumber</i> .	A CAN reset was requested via general purpose input <i>GPInumber</i> (see <i>Inputs/Outputs – Inputs</i> on page 105).
CANopen on interface <i>CANnumber</i> changed state to " <i>name</i> ".	The CANopen at interface <i>CANnumber</i> has changed state to " <i>name</i> " (state of NMT State Machine according to CiA DS 301).
Configuration changed.	The Configuration of device was changed (via the MICT or via fieldbus).
Date and time set.	The date and the time have been set.
Device (firmware <i>number.number.number.number</i>) started at a supply voltage of <i>x V</i> .	The device (firmware <i>number.number.number.number</i>) was started with a supply voltage of <i>x V</i> .
Device reset requested by <i>GPInumber</i> failed because pickup signals have been detected.	The device reset requested by <i>GPInumber</i> failed because pickup signals have been detected (see <i>Inputs/Outputs – Inputs</i> on page 105).
Device switched off.	The device was switched off.
Engine operating hours set to <i>x h</i> .	The engine operating hours set to <i>x h</i> .

8 Settings via the MICT

Information	Description
Failed to change PIN of access control level " <i>number</i> ".	Failed to change PIN of access control level " <i>number</i> " (see <i>Access Control for MIC3+</i> on page 76).
Failed to disable access control.	The access control could not be disabled (see <i>Access Control for MIC3+</i> on page 76).
Failed to enable access control.	The access control could not be enabled (see <i>Access Control for MIC3+</i> on page 76).
Failed to reset all access control PINs.	Failed to reset all PINs for access control (see <i>Access Control for MIC3+</i> on page 76).
Firing disabled (Start/Stop In: <i>value</i> , CAN: <i>value</i> , RS485: <i>value</i>)	<p>The firing is disabled, because at least one of the inputs (start/stop input, CAN interface, RS485 interface) used for the firing release is disabled. The inputs can have the following values:</p> <ul style="list-style-type: none"> – <i>enabled</i>: Firing enabled – <i>disabled</i>: Firing disabled – <i>n/a</i>: not used
Firing enabled (Start/Stop In: <i>value</i> , CAN: <i>value</i> , RS485: <i>value</i>)	<p>The firing is enabled, because all inputs (start/stop input, CAN interface, RS485 interface) used for the firing release are enabled. The inputs can have the following values:</p> <ul style="list-style-type: none"> – <i>enabled</i>: Firing enabled – <i>disabled</i>: Firing disabled – <i>n/a</i>: not used
J1939 on interface CAN <i>number</i> changed state to " <i>name</i> ".	<p>J1939 on interface CAN<i>number</i> changed state to "<i>name</i>". Following statuses are possible:</p> <ul style="list-style-type: none"> – <i>Enter/Start succeeded</i> The CAN mode <i>J1939</i> or <i>ALL-IN-ONE (J1939)</i> was started. – <i>Start failed</i> Initialization failed. – <i>Stop</i> Assignment of the <i>Source Address</i> was unsuccessful. A different source address needs to be set in the configuration (see <i>Miscellaneous – Communication</i> on page 106). – <i>Leave</i> Left CAN mode <i>J1939</i> or <i>ALL-IN-ONE (J1939)</i>.

8 Settings via the MICT



Information	Description
One or more messages are lost due to exhausted memory pool or message queue overrun.	One or more messages were lost because there was insufficient storage space or too many messages were queued.
Operational error acknowledged.	Operational errors are acknowledged.
PIN of access control level " <i>number</i> " changed.	PIN of access control level " <i>number</i> " changed (see <i>Access Control for MIC3+</i> on page 76).
Self test denied because no outputs are configured.	The self test could not be carried out because no outputs are configured (see <i>Self Test</i> on page 72).
Self test started.	The self test was started (see <i>Self Test</i> on page 72).
Self test stopped.	The self test was stopped (see <i>Self Test</i> on page 72).
Spark plug operating hours set to <i>x h</i> .	The spark plug operating hours were set to <i>x h</i> .
Speed (<i>x RPM</i>) exceeded maximum allowed speed (<i>yRPM</i>) at power-on. Waiting for engine stop.	Speed (<i>x RPM</i>) has exceeded the maximum speed (<i>y RPM</i>) during operation. The ignition controller is waiting for the engine to stop.
Wrong pickup signal polarity on pickup input <i>PUNumber</i> detected. Reversing polarity internally.	Wrong pickup polarity detected at pickup input <i>PUNumber</i> . Reversing polarity internally.

8.12.6.2 Warnings

Contrary to errors, warnings do not result in the engine being shut down.

Warning	Description
Configuration data checksum error. Using default configuration.	The checksum of the configuration data is faulty. The default configuration is used. This message may appear during an upgrade/downgrade of the firmware. Check your configuration data and the MICT version being used. Then download the configuration to the device once again.
Configuration invalid. Using previous configuration.	The configuration is invalid. The previous configuration is used. This message may appear during an upgrade/downgrade. Check your configuration data and the MICT version being used. Then download the configuration to the device once again.
Disable secondary diagnostic due to output <i>Anumber</i> .	Secondary diagnosis disabled due to output <i>Anumber</i> shut off. Check the ignition coil and wiring at the corresponding output.

8 Settings via the MICT

Warning	Description
General warning <i>number</i> .	General warning <i>number</i> . An undefined warning has occurred. If this occurs repeatedly, please contact MOTORTECH.
Incompatible coil parameters received, secondary voltage diagnostics disabled.	Incompatible coil parameters received. The secondary voltage diagnostics have been disabled. This message may appear during an upgrade/downgrade. Check your configuration data and the MICT version being used. Then download the configuration to the device once again.
Invalid coil data received.	Invalid coil data received. This message may appear during an upgrade/downgrade. Check your configuration data and the MICT version being used. Then download the configuration to the device once again.
Pickup configuration invalid.	The pickup configuration is invalid. This message may appear during an upgrade/downgrade. Check your configuration data and the MICT version being used. Then download the configuration to the device once again.
Power output (<i>x W</i>) exceeded limit (<i>y W</i>) at a supply voltage of <i>z V</i> .	The power output (<i>x W</i>) exceeded warning threshold limit (<i>y W</i>) for longer than two minutes at a supply voltage of <i>z V</i> .
Speed (<i>x RPM</i>) exceeded overspeed limit (<i>y RPM</i>). Previous speed was <i>z RPM</i> .	Speed (<i>x RPM</i>) exceeded overspeed limit (<i>y RPM</i>). Previous speed was <i>z RPM</i> (see <i>Engine – Pickups</i> on page 91). The reason for this may also be an interference coupling on the trigger signal.
Temperature of device (<i>x °C</i>) exceeded limit (<i>y °C</i>)	The temperature of the device (<i>x °C</i>) exceeded warning threshold limit (<i>y °C</i>) for more than two minutes. Ensure that there is sufficient air circulation and/or cooling.

8.12.6.3 Alarms

Alarms can be defined in the configuration. When doing so, each alarm is assigned a *number* (see *Inputs/Outputs – Alarms* on page 101).

Alarm	Description
Alarm <i>number</i> " <i>description</i> " acknowledged.	The alarm <i>number</i> " <i>description</i> " was acknowledged.
Alarm <i>number</i> " <i>description</i> " triggered.	The alarm <i>number</i> " <i>description</i> " was triggered.
All alarms reset.	All alarms reset.

8 Settings via the MICT



8.12.6.4 Failure

All system or operational errors cause the engine to be shut down.

Error	Description
Alarm shutdown caused by alarm <i>number</i> .	The engine was shut down by alarm <i>number</i> . This function was defined in the configuration (see <i>Inputs/Outputs – Alarms</i> on page 101).
Assertion failed (x).	An assertion was not adhered to (x). For example, an assumption for a value was not fulfilled in the firmware. If the error occurs again after restarting the device, please contact MOTORTECH.
Critical error x (y).	Critical error x (y). If the error occurs again after restarting the device, please contact MOTORTECH.
Current sensor of output bank <i>name</i> failed.	The current sensor of output bank <i>name</i> failed. Restart the ignition controller. If the error occurs again after restarting the device, please contact MOTORTECH.
Cycle signal was missing, so more trigger signals were counted than available per cycle.	Cycle signal was missing, so more trigger signals were counted than available per cycle. Check the pickups and the corresponding configuration (see <i>Engine – Pickups</i> on page 91). Furthermore, also pay attention to the instructions in the section entitled <i>Pickup Input Errors</i> on page 158.
Device started after supply voltage failure.	The device was started after a failure of the supply voltage. Please check the power supply of the device where applicable.
General error <i>number</i> .	General error <i>number</i> . An undefined error has occurred. Restart the ignition controller. If the error occurs again after restarting the device, please contact MOTORTECH.
General error in pickup pre-processing on pickup input P <i>Number</i> .	General error in pickup pre-processing on pickup input P <i>Number</i> . Check the pickups and the corresponding configuration (see <i>Engine – Pickups</i> on page 91). Furthermore, also pay attention to the instructions in the section entitled <i>Pickup Input Errors</i> on page 158.
Number of trigger signals (<i>number</i>) counted does not match the configured value.	Number of trigger signals (<i>number</i>) counted does not match the configured value. Check the pickups and the corresponding configuration (see <i>Engine – Pickups</i> on page 91). Furthermore, also pay attention to the instructions in the section entitled <i>Pickup Input Errors</i> on page 158.

8 Settings via the MICT

Error	Description
Operational error caused by pickup signals. PU ₁ = x, PU ₂ = y.	<p>An operational error was caused by pickup signals (pickup PU₁ = x, pickup PU₂ = y).</p> <p>For information on the numbers shown, please consult the documentation on the pickup status bits on the storage device enclosed with the ignition controller. You can open the file via the menu: <i>Documentation</i> -> <i>More information</i>.</p> <p>Check the pickups and the corresponding configuration (see <i>Engine – Pickups</i> on page 91). Furthermore, also pay attention to the instructions in the section entitled <i>Pickup Input Errors</i> on page 158.</p>
Output board identification failed due to a checksum error.	The identification of the output board failed due to a checksum error. Restart the ignition controller. If the error occurs again after restarting the device, please contact MOTORTECH.
Output board identification failed due to incompatible hardware.	The identification of the output board failed due to incompatible hardware. Restart the ignition controller. If the error occurs again after restarting the device, please contact MOTORTECH.
Output board identification failed due to missing data.	The identification of the output board failed due to missing data. Restart the ignition controller. If the error occurs again after restarting the device, please contact MOTORTECH.
Output board identification failed due to unknown error <i>number</i> .	The identification of the output board failed due to unknown error <i>number</i> . Characteristic data of the output board could not be read, they are defective or do not match the device. Restart the ignition controller. If the error occurs again after restarting the device, please contact MOTORTECH.
Output board identification failed due to unknown hardware.	The identification of the output board failed due to unknown hardware. Characteristic data of the output board could not be read, they are defective or do not match the device. Restart the ignition controller. If the error occurs again after restarting the device, please contact MOTORTECH.
Power failure detected on output <i>Anumber</i> .	Power supply fault in output board caused by output <i>Anumber</i> was detected. Restart the ignition controller. If the error occurs again after restarting the device, please contact MOTORTECH.

8 Settings via the MICT



Error	Description
Power output (x W) exceeded error threshold limit (y W) at a supply voltage of z V.	The power output (x W) exceeded failure threshold (y W) at a supply voltage of z V.
Power output (x W) exceeded permanent limit (y W) at a supply voltage of z V.	The power output (x W) exceeded warning threshold limit (y W) for longer than three minutes at a supply voltage of z V.
Self test aborted because pickup signals have been detected on pickup input PUNumber.	Self test aborted because pickup signals have been detected on pickup input PUNumber. Self test can only be carried out when engine is at a standstill (see <i>Self Test</i> on page 72). Potential causes: <ul style="list-style-type: none"> – Interference coupling on pickup signal – Engine was started
Speed (x RPM) exceeded overspeed limit (y RPM) at trigger signal number.	The speed (x RPM) exceeded overspeed limit (y RPM) at trigger signal number (see <i>Engine – Pickups</i> on page 91). The reason for this may also be an interference coupling on the trigger signal.
Supply voltage failure.	Supply voltage failure. Please check the power supply of the device where applicable.
Temperature of controller board (x °C) exceeded limit (y °C).	The temperature of controller board (x °C) exceeded limit (y °C). Ensure that there is sufficient air circulation and/or cooling.
Temperature of device (x °C) exceeded error threshold limit (y °C).	The temperature of the device (x °C) exceeded failure threshold (y °C). Ensure that there is sufficient air circulation and/or cooling.
Temperature of device (x °C) exceeded permanent limit (y °C).	The temperature of the device (x °C) exceeded warning threshold limit (y °C) for more than two minutes. Ensure that there is sufficient air circulation and/or cooling.
Temperature of output board (x °C) exceeded limit (y °C).	The temperature of output board (x °C) exceeded limit (y °C). Ensure that there is sufficient air circulation and/or cooling.
Temperature sensor of controller board failed.	The temperature sensor of controller board failed. Restart the ignition controller. If the error occurs again after restarting the device, please contact MOTORTECH.
Temperature sensor of output board failed.	The temperature sensor of output board failed. Restart the ignition controller. If the error occurs again after restarting the device, please contact MOTORTECH.

8 Settings via the MICT

Error	Description
Trigger period (x , triggers counted y) is not in acceptable range compared to previous trigger period (z).	The trigger period (x , triggers counted y) is not in acceptable range compared to previous trigger period (z). Check the pickups and the corresponding configuration (see <i>Engine – Pickups</i> on page 91). Furthermore, also pay attention to the instructions in the section entitled <i>Pickup Input Errors</i> on page 158.
Trigger signal missing. Current trigger period (triggers counted x) is out of the specified range related to the previous trigger period.	The trigger signal is missing. Current trigger period (triggers counted x) is out of the specified range compared to the previous trigger period. Check the pickups and the corresponding configuration (see <i>Engine – Pickups</i> on page 91). Furthermore, also pay attention to the instructions in the section entitled <i>Pickup Input Errors</i> on page 158.

8.12.7 Runtime Data – Diagnostics

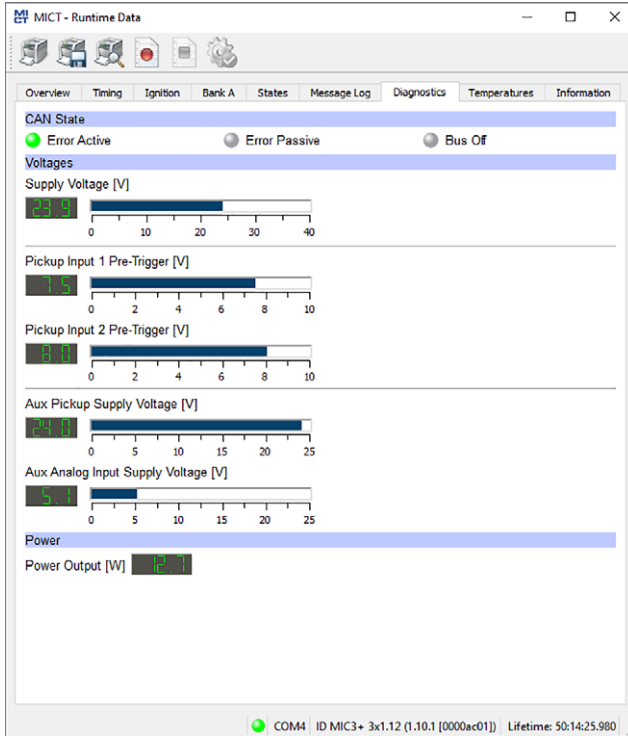

The following information is provided:

- **CAN State**

The status display indicates the current error handling status of the device for the CAN bus communication:

 - **Error Active**

The device is in normal status of the bus communication. If an error occurs in the communication, the device sends an active error flag.
 - **Error Passive**

After a defined number of errors in the bus communication, the device changes to the status *Error Passive*. If another error occurs, the device sends a passive error flag.
 - **Bus Off**

The device is disconnected from the CAN bus due to error accumulations in the bus communication.

■ 8 Settings via the MICT

- Voltages
 - **Supply Voltage**
Current voltage supply of the controller board.
 - **Pickup Input Pre-Trigger Voltage**
Current pre-trigger voltage for the pickup inputs (refer to *Engine – Pickups* on page 91). During operation the pre-trigger voltage for passive pickups is increased depending on the speed, so that the ignition controller is less prone to interferences.
 - **Aux. Pickup Supply Voltage**
Current auxiliary supply voltage of the pickups (refer to *Engine – Pickups* on page 91)
 - **Aux. Analog Input Supply Voltage**
Current auxiliary supply voltage of the analog inputs (refer to *Timing – Analog Inputs* on page 95)
- Power
 - **Power Output**
Current output

8.12.8 Runtime Data – Temperatures

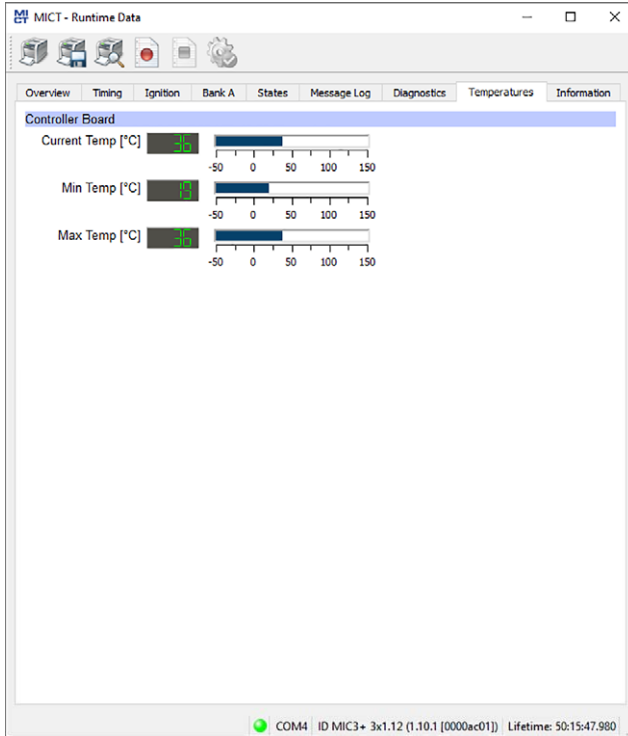

In the window you receive an overview of the temperatures of the controller board. The maximum and minimum values are reset at each new start of the ignition controller.

The following information is provided:

- **Controller Board**
 - **Current Temp.**
Current temperature of the controller board
 - **Min. Temp.**
Minimum measured temperature of the controller board
 - **Max. Temp.**
Maximum measured temperature of the controller board

8 Settings via the MICT

8.12.9 Runtime Data – Information

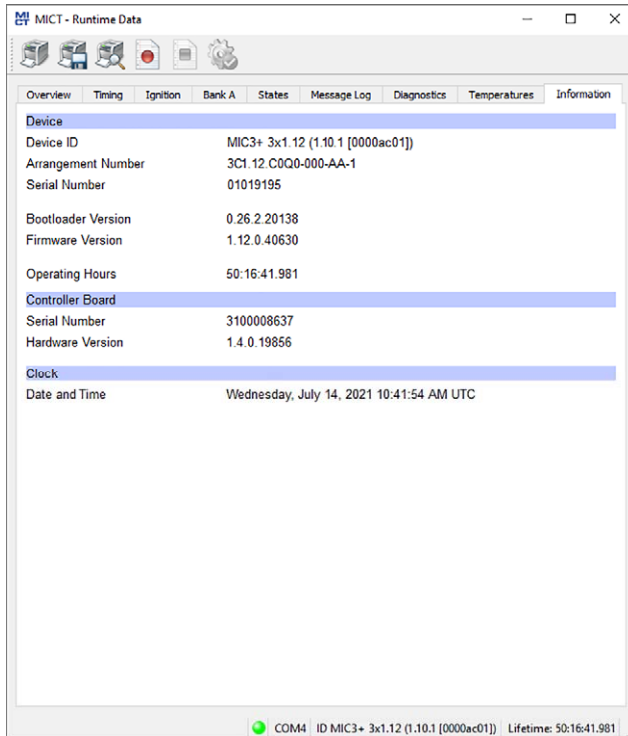

The screenshot shows the 'MICT - Runtime Data' application window. The 'Information' tab is selected, displaying the following data:

Device	
Device ID	MIC3+ 3x1.12 (1.10.1 [0000ac01])
Arrangement Number	3C1.12.C0Q0-000-AA-1
Serial Number	01019195
Bootloader Version	0.26.2.20138
Firmware Version	1.12.0.40630
Operating Hours	50:16:41.981
Controller Board	
Serial Number	3100008637
Hardware Version	1.4.0.19856
Clock	
Date and Time	Wednesday, July 14, 2021 10:41:54 AM UTC

At the bottom of the window, a status bar shows: ● COM4 ID MIC3+ 3x1.12 (1.10.1 [0000ac01]) Lifetime: 50:16:41.981

In this view, you can find an overview of the device and version data. If problems arise, you can print the current runtime data and send them to the MOTORTECH Service Department by fax or as a PDF file by email. For fast support, we will then immediately have all required information.

8.13 Log



Click on the symbol to open the window *Log*. This window is only available to users with authorizations starting at the access level *Advanced Service*.

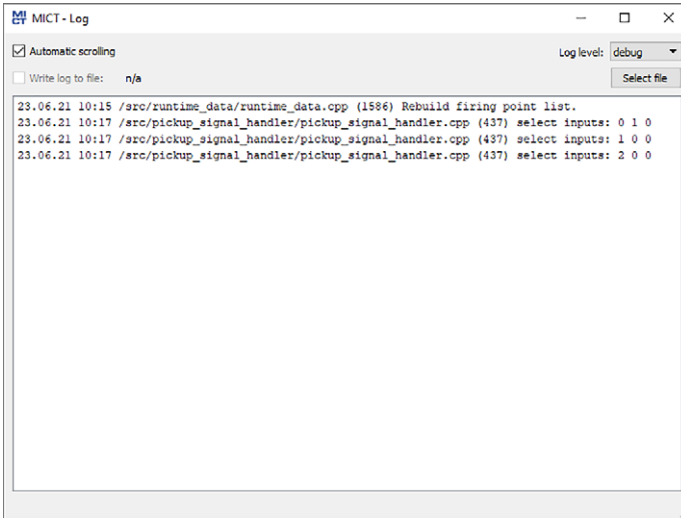

The window *Log* serves to support error diagnostics by MOTORTECH.

- **Automatic scrolling**
If the function is active, the view panel focuses on the latest message.
- **Log level**
The selection of the log level is specified by MOTORTECH if needed.
- **Write log to file**
This checkbox activates or deactivates, respectively, the saving of the logged data in a selected file. If the function is disabled, the logged data are merely shown on the display.
- **Select file**
With this button, you can select a file to which you want to save the logged data.

8 Settings via the MICT

If you are prompted to create a log file in the case of a service request, proceed as follows:

1. Open the window *Log* via the toolbar or the menu bar.
2. Select a path with the *Select file* button and enter the file name for the log file.
 - ▶ If the file does not yet exist, it is automatically created with the extension *.log*.
3. Activate the checkbox *Write log to file*.
4. Select the level specified by MOTORTECH from the list *Log level*.
5. Leave the window open.
 - ▶ The log messages are logged both in the window and in the selected file.



Date and time of ignition controller

The date and time can be individually configured for each ignition controller and saved in the device. The device does not adjust automatically for daylight savings time. Hence, deviations may occur between the device time and the time on the computer used to access the device.

Correspondingly, the times indicated for the states, messages, and in the log reflect the time of the ignition controller. The current time of the ignition controller is shown in the view *Runtime Data – Information*. You can adjust the time of the ignition controller by entering the desired time in the menu via *Device -> Set date and time*.

8.14 Runtime Adjustments



Click on the symbol to open the window *Runtime Adjustments*. This window is only available to users with authorizations starting with access level *Service*.



Runtime adjustments are implemented directly

All runtime adjustments are implemented directly without requiring the input to be confirmed and are retained even in the case of a MIC3+ restart. Changes that have been saved in the device configuration are only displayed after re-uploading the device configuration in the MICT's main window.

8 Settings via the MICT



8.14.1 Runtime Adjustments – Reset

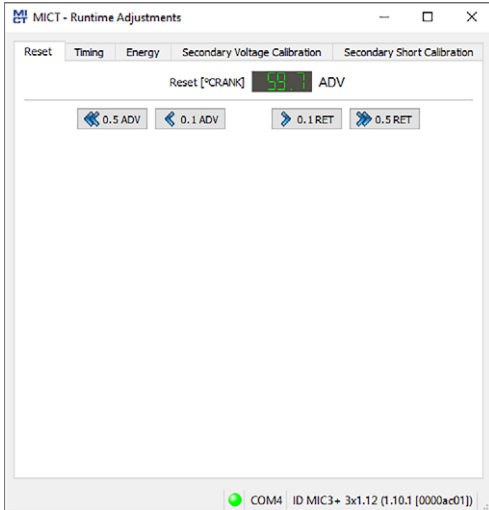

The index/reset position can be corrected by 5° crankshaft (advanced/retarded) while the device is being operated. The correction is made with the buttons:

- **0.1 ADV/RET**
in 0.1° increments to advance or retard
- **0.5 ADV/RET**
in 0.5° increments to advance or retard

Changes are implemented immediately and stored in the configuration provided in the device.

If the correction range is not sufficient, the reset/index position must be adjusted in the configuration (refer to *Engine – Pickups* on page 91).

8 Settings via the MICT

8.14.2 Runtime Adjustments – Timing

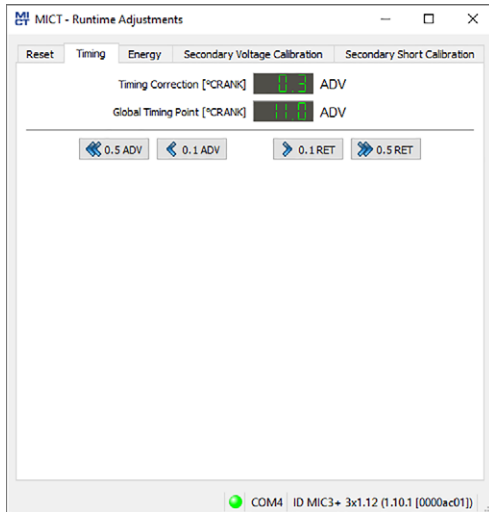

The global ignition timing position can be corrected by 50 °crankshaft (advanced/retarded) while the device is being operated. The correction is made with the buttons:

- **0.1 ADV/RET**
in 0.1° increments to advance or retard
- **0.5 ADV/RET**
in 0.5° increments to advance or retard

The limit for the ignition timing set in the schedule (refer to *Timing – Schedule A/B – General* on page 97) cannot be exceeded or not reached with the runtime adjustment.

The correction of the global ignition timing is immediately implemented and also remains in place if the device is restarted. NOTICE: The configuration defined in the device is not changed.

8 Settings via the MICT



8.14.3 Runtime Adjustments – Energy

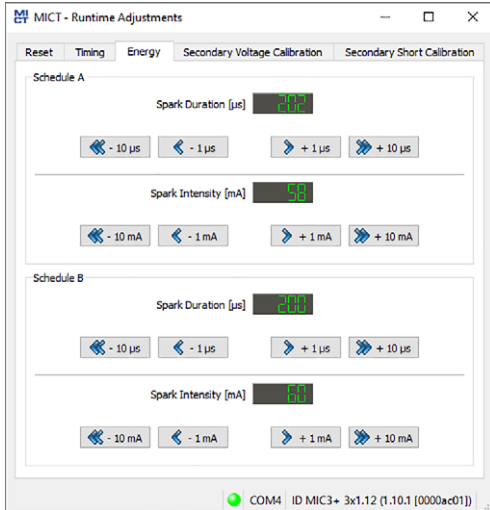

The energy settings can be separately adjusted for both schedules. Changes are implemented immediately and stored in the configuration provided in the device.

Spark Duration

- +/- 1 μs
lengthen or shorten in microsecond increments
- +/- 10 μs
lengthen or shorten in 10 μs increments

Spark Intensity

- +/- 1 mA
increase and decrease in milliamper increments
- +/- 10 mA
increase or reduce in 10 mA increments

8 Settings via the MICT

8.14.4 Runtime Adjustments – Secondary Voltage Calibration

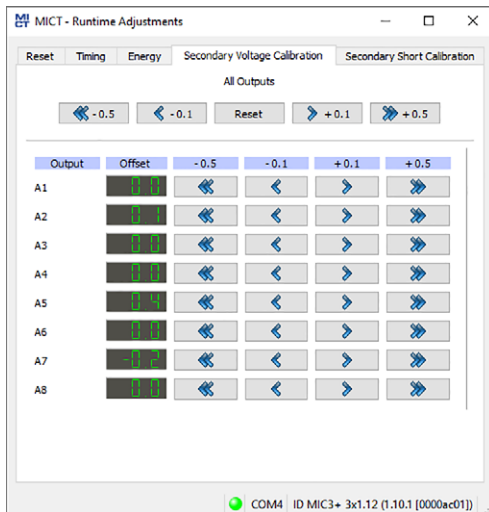

The secondary voltage estimation can be calibrated in this window when using ignition coils that support this function:

A correction value without units can be set for the secondary voltage estimation for every output to increase the accuracy of the secondary voltage estimation for each individual cylinder. This allows, for instance, different cable lengths on the engine to be compensated.

The secondary voltage estimation should be calibrated under full load at a nominal speed. The adjustment can be made using the relevant global or individual cylinder buttons. The value range depends on the set ignition coil. 0.0 is set as the standard value for all cylinders.

Changes are implemented immediately and stored in the configuration provided in the device.

8.14.5 Runtime Adjustments – Secondary Short Calibration

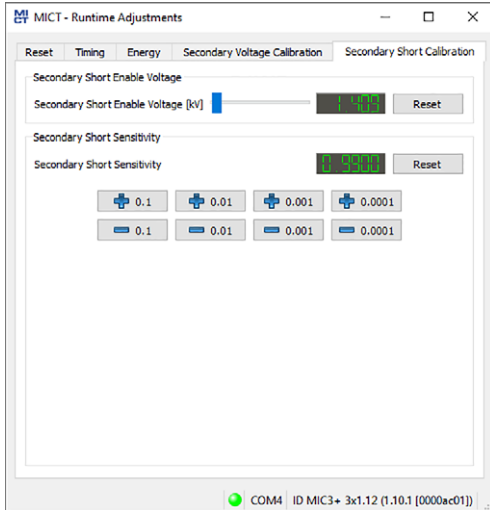

The starting voltage and sensitivity for the secondary short-circuit detection can be adjusted. Changes are implemented immediately and stored in the configuration provided in the device.

Secondary Short Enable Voltage [kV]

Set the necessary average ignition voltage required to activate the secondary short-circuit monitoring:

- The secondary short detection is always activated at a value of 0 kV.
- The secondary short detection is always deactivated at a value of 65.535 kV.

Secondary Short Sensitivity

The permitted value range depends on the set ignition coil.

Set the sensitivity of the short-circuit detection e.g. as follows:

- The sensitivity is high at a value of 0.98.
- The sensitivity is low at a value of 1.02.



Adjust the sensitivity of the short-circuit monitoring

If a short-circuit is misdiagnosed at a sensitivity of 1.00, the sensitivity must be set to 1.02.

If a short-circuit is not detected at a sensitivity of 1.00, the sensitivity must be set to 0.98.

8 Settings via the MICT

8.15 Cylinder Individual Offsets



Click on the symbol to open the window *Cylinder Individual Offsets*. This window is only available to users with authorizations starting with access level *Service*.

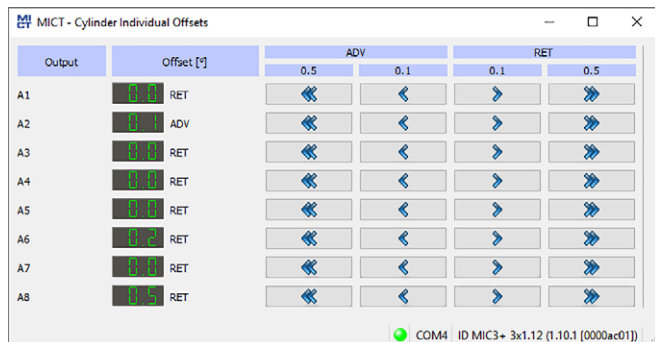

The cylinder individual offset can be applied to the position of the timing point while the controller is being operated. Offset via keys:

- **0.1 ADV/RET**
in 0.1° increments to advance or retard
- **0.5 ADV/RET**
in 0.5° increments to advance or retard

The adjustment option of this function is limited by the specified settings in the configuration. Refer to the section *Timing – Schedule A/B – General* on page 97.



Immediate execution of the changes

Please note that changes made to the timing point are executed immediately at the next firing of the corresponding cylinder. The maximum performed change per cycle is however limited by the corresponding setting in the configuration. For this read *Timing – Miscellaneous* on page 100.



Save changes automatically

Please remember that changes to the ignition timing are saved automatically.

8 Settings via the MICT



8.16 Schedule Curve



Click on the symbol to open the window *Schedule*.

8.16.1 Schedule Curve – Simulation

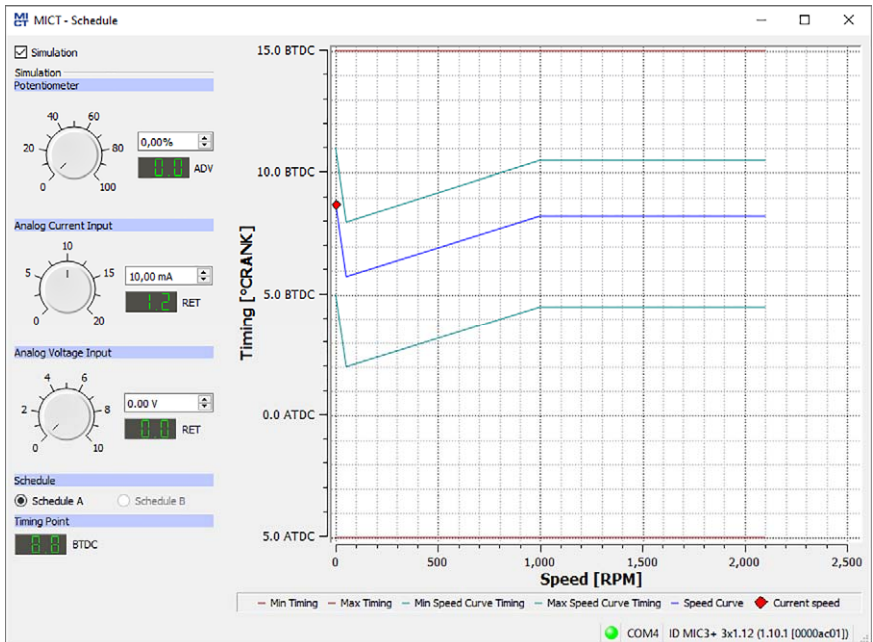

The schedule curve visualizes the configurations of the schedules and simulates the influence of the inputs over the speed range. With the optional input fields, you can switch between schedule A and B. Changes made by turning the control buttons or entering the desired values are displayed simultaneously.

- **Simulation**
The simulation is activated or disabled using the checkbox.
- **Potentiometer**
Simulation of the potentiometer
 - Control button for adjustments between 0 % and 100 %
 - Field for manual input of the desired value in %
 - Displays the value in °crankshaft by which the timing is offset

■ 8 Settings via the MICT

- **Analog Current Input**
Simulation of the analog current input
 - Control button for adjustments between the configured values (e.g. 0 mA and 20 mA)
 - Field for manual input of the desired value in mA
 - Displays the value in °crankshaft by which the timing is offset
- **Analog Voltage Input**
Simulation of the analog voltage input
 - Control button for adjustments between the configured values (e.g. 0 V and 10 V)
 - Field for manual input of the desired value in V
 - Displays the value in °crankshaft by which the timing is offset
- **Schedule A/B**
Select between Schedule A and B
- **Timing Point**
Displays the global ignition timing as it changes during the simulation.

While connected to the device, the ignition timing is simulated depending on the actual engine speed and marked as  in the diagram.

8 Settings via the MICT



8.16.2 Schedule Curve – Runtime Values

If the checkbox *Simulation* is unchecked, the *Schedule curve* window switches to the current runtime data.

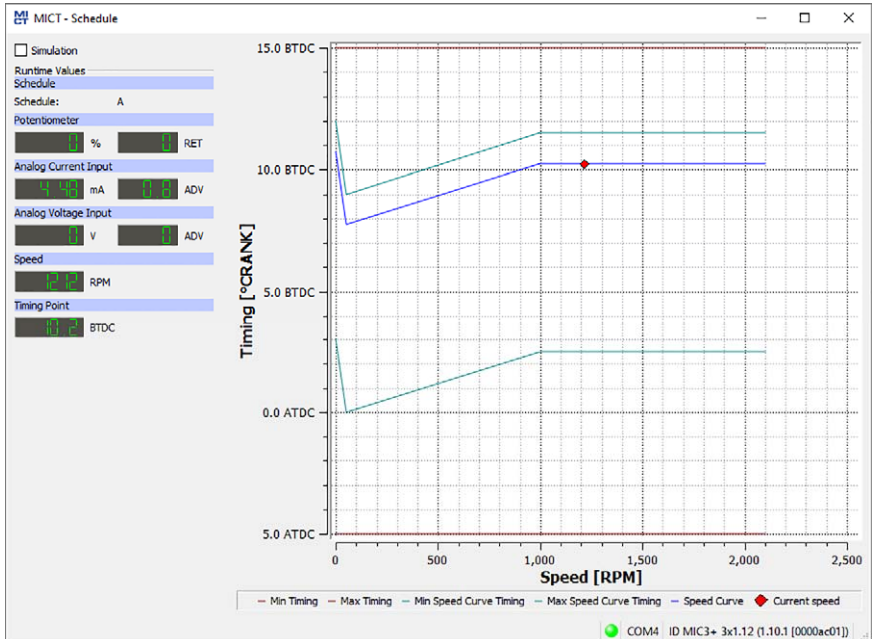

The following information is provided:

- **Schedule**
Displays the currently selected schedule.
- **Left column: Potentiometer, Analog Current Input, Analog Voltage Input**
Displays the new calculated adjustment values for the potentiometer, current and voltage input.
- **Right column: Potentiometer, Analog Current Input, Analog Voltage Input**
Display of values supplied by the ignition controller for the potentiometer, current and voltage input.
- **Speed**
Display of the current speed
- **Timing Point**
Displays the current global ignition timing.





8 Settings via the MICT

8.17 Coils

The MICT has a database with technical information on MOTORTECH ignition coils. Open the database as follows:

Tools -> Coils

You have the option of storing and printing information on the ignition coils present in the database. For this purpose, the following functions are at your disposal in the toolbar in the *Coils* window.

Symbol	Function
	Stores the information on the selected ignition coil in a format that is appropriate for configuring the MIC ₃ + via fieldbus.
	Prints the selected coil data set.
	Prints the selected coil data set as PDF file.
	Opens the print preview.

Coils

- **Device**
Select an ignition controller.
- **Coil**
Select an ignition coil.



Select the correct ignition controller

The ignition coil data depends on the ignition controller used. Always select the ignition controller for which you are using the coils in order to obtain the correct data.

8 Settings via the MICT



8.17.1 General

MICT - Coils

File

Coils

Device: MIC3+

Coil:

- 06.50.003
- 06.50.035
- 06.50.055
- 06.50.065
- 06.50.100
- 06.50.102
- 06.50.104
- 06.50.105
- 06.50.107
- 06.50.108
- 06.50.112
- 06.50.113
- 06.50.145
- 06.50.146
- 06.50.147
- 06.50.148
- 06.50.155
- 06.50.156
- 06.50.157
- 06.50.158
- 06.50.162
- 06.50.165
- 06.50.300
- 06.50.301
- 93.09.150
- 95.08.003
- 95.08.040-6
- 95.08.050-14.5
- 95.08.222-12
- 95.08.222-6
- 95.09.005
- 95.09.050-6

General Min. Energy Limit Curve

Details

Name: 06.50.104
Coil Type Id: 6
Data Version: 2

Secondary diagnostics available if max. breakdown voltage is set in range 38 kV to 40 kV. Additionally it is required that the energy limit is set sufficiently high according to the min. energy limit curve.

Coil Parameters

Parameter	Min.	Max.
Max. Breakdown Voltage [kV]	19	40
Spark Intensity [mA]	32	190
Secondary Voltage Estimation Calibration	-5	5
Secondary Short Sensitivity	0.98	1.02

Details

The following information is provided:

- **Name**
Coil name
- **Coil Type ID**
Used to clearly identify the ignition coil
- **Data Version**
Shows data version of the ignition coil selected in the database. The data version of the ignition coil configured in the ignition controller is displayed in the runtime data in the view *Ignition* (refer to *Runtime Data – Ignition* on page 114). The Automatic Online Update should be activated to ensure that the coil database always has the latest data sets. Additional information on the online update is provided in the section *Online Update Settings* on page 71.

■ 8 Settings via the MICT

- Illustration of the ignition coil
- Information on the conditions under which a secondary diagnosis is possible using the displayed ignition coil.

Coil Parameters

The following information is provided:

- **Max. Breakdown Voltage [kV]**
Displays the permitted value range for the maximum breakdown voltage in kV. The maximum breakdown voltage is configured in the view *Timing – Schedule A/B – Energy* (refer to *Timing – Schedule A/B – Energy* on page 99).
- **Spark Intensity [mA]**
Displays the permitted value range for the spark intensity in mA. The spark intensity is configured in the view *Timing – Schedule A/B – Energy* (refer to *Timing – Schedule A/B – Energy* on page 99).
- **Secondary Voltage Estimation Calibration**
Displays the permitted value range for the secondary voltage estimation calibration. The calibration of the secondary voltage estimation takes place in the view *Engine – Ignition Coils* (refer to *Engine – Ignition Coils* on page 89) and in the runtime adjustments (refer to *Runtime Adjustments – Secondary Voltage Calibration* on page 142).
- **Secondary Short Sensitivity**
Displays the permitted value range for the calibration of the secondary short sensitivity. The calibration of the secondary short sensitivity takes place in the view *Engine – Ignition Coils* (refer to *Engine – Ignition Coils* on page 89) and in the runtime adjustments (refer to *Runtime Adjustments – Secondary Short Calibration* on page 143).

8 Settings via the MICT



8.17.2 Min. Energy Limit Curve

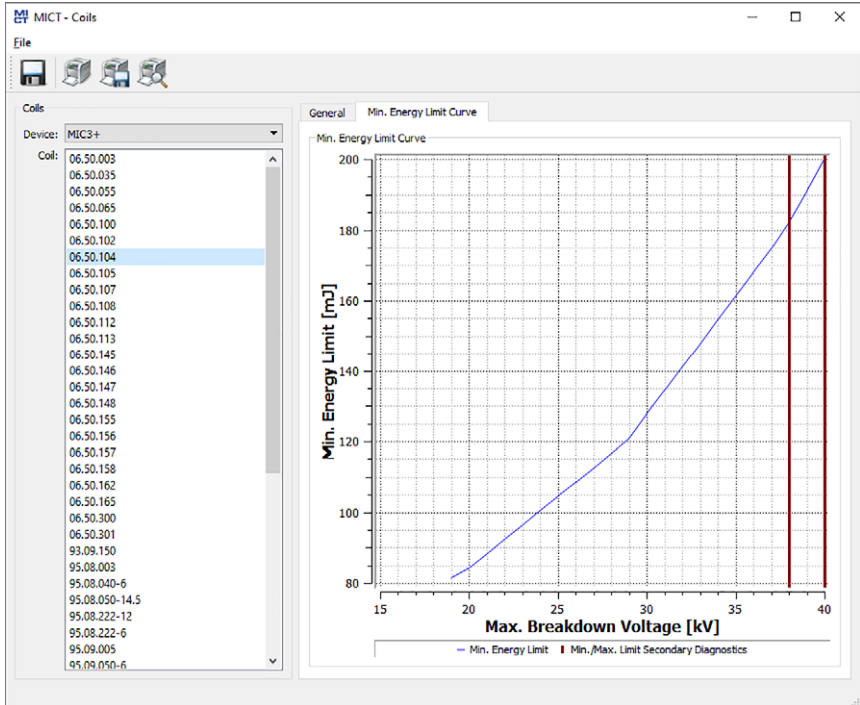

Min. Energy Limit Curve

The curve provides information on the energy in mJ necessary to achieve a certain maximum breakdown voltage in kV. The two vertical bars show the breakdown voltage area, in kV, in which a secondary diagnosis is possible. The corresponding energy settings can be found in the view *Timing – Schedule A/B – Energy* (refer to *Timing – Schedule A/B – Energy* on page 99).

When printing the coil data set, the curve values are also provided as a list.

9 Operation

9.1 Start-up

Before you start up the MIC3+ ignition controller, take note of the following:

- Were the correct engine, ignition sequence, and output configuration selected? If you are unsure, contact MOTORTECH or the corresponding engine manufacturer.
- Ensure that the firing order of the engine and/or the wiring of the output cable harness are carried out correctly.
- Is the wiring of all pickups compliant with the drawings given in this operating manual?
- Are the distances of the pickups to trigger discs, reluctor pins, etc. correctly set (see chapter *Determine the Installation Location of the Pickup* on page 34)?
- Ensure that the data were transferred flawlessly to the controller.
- Check whether the start/stop input is set to *Firing Active*, or whether it works according to the control requirements of the master control.
- Check whether the input contact for parameter settings A/B (*Schedule A/B*) functions and ensure that the correct schedule (A or B) was selected for start-up.
- Close the service screw and the service cover after completing the installation and configuration.
- Ensure that no gas is present in the inlet and exhaust systems before you start the engine.
- Ensure that the gas valve is closed.
- Perform the normal engine start-up process while the gas valve is closed (start only).
- Connect a stroboscope to the first firing cylinder (cylinder #1) and check whether the timing point set on the ignition controller coincides with the actual timing point on the crankshaft. If the ignition timing does not coincide exactly, change it (see chapter *Runtime Data* on page 109) until the optimal setting is reached. If the ignition does not fire, read the instructions in section *Troubleshooting* on page 159.
- Check all other cylinders for correct ignition. If they are not correct, stop the engine, and recheck wiring and ignition sequence for correctness.
- Stop the starting process. If no problems occur, start the engine in accordance with the specifications of the engine manufacturer.

9.2 Shutdown

The ignition controller is shut down by disconnecting it from the power supply.

9.3 Firmware Update

Using the MOTORTECH Flash Tool, you can update the firmware of the ignition controller. The program is provided on the storage device (USB flash drive or CD-ROM supplied).

Install MOTORTECH Flash Tool





Install the MOTORTECH Flash Tool as follows:

1. Start the installation:
 - Via the menu:
Start the file *Start.exe* on the storage device. Start the installation routine for the MOTORTECH Flash Tool via *Software -> MOTORTECH Flash Tool -> Install MOTORTECH Flash Tool*.
 - Directly from the storage device:
Start the installation routine of the MOTORTECH Flash Tool directly. It is on the storage device in the subdirectory *Installation* and for example named as follows: *MOTORTECH-Flash-Tool-0.23.00000-setup.exe*.
2. Install the program.
Follow the instructions of the installation routine. Note that the license agreement terms must be accepted before using the MOTORTECH Flash Tool.
3. If the USB driver is not yet installed, also install it via the menu or directly from the storage device.
 - Via the menu:
Software -> USB Drivers -> Install USB Drivers
 - Directly from the storage device:
Start the exe file in subdirectory *Drivers* (e.g. *CDM21226_Setup.exe*).
 - ▶ The MOTORTECH Flash Tool is set up. You can now connect your computer to the ignition controller via the USB interface.

9 Operation

Menu Bar and Toolbar

After launching the MOTORTECH Flash Tool, the following functions are available to you via the icons on the toolbar and the entries in the menu bar:

Symbol	Menu	Function
	<i>File -> Open</i>	Opens a firmware file.
	<i>File -> Quit</i>	Exits the program.
	<i>View -> Extended file information view</i>	Fades in / out additional information of the firmware file.
	<i>View -> Extended connection settings</i>	Fades in / out additional information and settings of the connection to the device.
	<i>View -> Reload file</i>	Reloads the file information of the selected firmware file.
	<i>Device -> Search devices</i>	Restarts the search for connected devices.
	<i>Device -> Flash device</i>	Starts the update process or downgrade process.
	<i>Settings -> Language</i>	Opens the window <i>Select Language</i> in which you can change the interface language of the program.
	<i>Help -> Help</i>	Opens the online help function.
	<i>Help -> About MOTORTECH Flash Tool</i>	Opens detailed information on the program.

Start Firmware Update



Access control for firmware update

If you have activated the access control for the ignition controller, you need the PIN for the level *Master* for the firmware update. For more information read the section *Access Control for MIC3+* on page 76.



Backup the existing configuration

Your device's configuration may be lost if the firmware update is not performed properly. Always backup the existing configuration via the MICT prior to performing an update. For more information read the section *Working with Configurations* on page 78.

To start a firmware update, proceed as follows:

1. If an MICT is connected with the ignition controller, disconnect this connection.
2. Start the MOTORTECH Flash Tool via *Start -> Programs -> MOTORTECH -> MOTORTECH Flash Tool -> x.x.x (e.g. 0.23.00000) -> MOTORTECH Flash Tool*.
 - ▶ The MOTORTECH Flash Tool will now start.
 - ▶ The software automatically checks all ports for connected devices.
3. In the *Status* section under *Device*, check if your device has been recognized properly.
 - ▶ If the MOTORTECH Flash Tool does not recognize a device that is connected to your computer via the USB interface, you can usually still carry out a firmware update. To do so, observe the instructions in the information windows of the MOTORTECH Flash Tool for the following steps.
4. Select in area *File* using the *Select* button the desired update file.
5. By reading the displayed file information, ensure that the update file is correct for your device.
6. Start the update process using the *Flash* button or using the menu or toolbar.
 - ▶ The ignition controller is restarted automatically.
 - ▶ Now, a window opens informing you about the firmware version currently used on your ignition controller and also about the relevant update version.
7. Confirm with *Yes* to proceed with the update process.
 - ▶ Now the update will start.
 - ▶ If the firmware update was successful, you will see a relevant message.
8. After a successful firmware update, check all configuration data.



Downgrade process

The process for a downgrade is largely the same as the update process. You will only be informed that a new firmware has been installed on the device.

9 Operation



Help with connection problems

If a correctly connected device is not found during the automatic search, this can, for example, be because too many communication interfaces are assigned and must be checked. In this case, an interface from the drop-down list *Port* in the area *Connection* can be selected and thus specified.

If the desired port is not yet displayed in the list or if the problem should continue, an adjustment of the time-outs for the connection helps. The time-out settings are displayed in the main view by the following entry in the menu bar: *View -> Extended connection settings*

Enter the following settings:

- **Update Request Timeout**
Adjustment range: 1,000 ms to 10,000 ms, standard value: 3,000 ms.
An extension of the time-out can be an advantage, especially with connection problems that occur because the computer has many assigned ports.
- **Start Timeout**
Adjustment range: 1,000 ms to 10,000 ms, standard value: 3,000 ms. A time-out change can be an advantage, especially with connection problems that occur because the communication between the computer and the device has been interrupted.

10.1 Possible Faults

The MIC₃₊ ignition controllers include several safety functions that can shut down the engine in case of fault:

- Overspeed protection
- External shut-down contact (Start/Stop)
- Misfire detection (primary)
- Internal failure of the high voltage supply
- Output Error Detection
- Shut down in the case of a faulty pickup or faulty pickup signals.
- Alarms
- Faulty voltage supply
- External EMI signals

10.2 Causes of Faults

10.2.1 Overspeed

The engine speed has exceeded the set overspeed value. As of firmware version 1.11.00000, an operating error caused by overspeed is indicated on the device by the status LED flashing four times (4 times red/off 250 ms, 750 ms off). Refer to the section *LED Functions* on page 28.

Potential Causes

- Speed controller does not function properly
- Fuel supply to engine is not optimal.
- Faulty pickup signal

10.2.2 Output Error Detection

An internal failure of the high voltage supply or a defective output switch occurs.

Potential Causes

- Hardware fault on the MIC₃₊
- Defect in the wiring (short circuit or open circuit)

10 Errors

10.2.3 Misfire Detection (Primary)

Misfiring due to an open circuit on the primary side was detected and displayed in the runtime data.

Potential Causes

- Defect in the output wiring
- Ignition coil defective

10.2.4 Pickup Input Errors

Faulty input signals from the pickups are detected.

Potential Causes

- Number of teeth on the flywheel does not match the set number.
- Damage to or uneven running of trigger disc
- Interference in the wiring of the pickup
- Wiring of the pickup incorrect
- Distance of the pickup incorrect
- Dirt on the pickup

Troubleshooting for Possible Causes

You will find information on possible causes of a pickup input error in the windows *Runtime Data – States* (see *Runtime Data – States* on page 117) and *Runtime Data – Message Log* (see *Runtime Data – Message Log* on page 123). When analyzing the messages shown there, please note that the number of the pickup (e.g. PU2) only names the pickup at which the error or problem was identified. Hence, this does not mean that this particular pickup also caused the problem. For example, if the pickup PU1 is defect, it is entirely possible that, under certain circumstances, the problem may only be identified at pickup input PU2.

For information on the numbers shown in the error messages (e.g. *PU1=0x00001002*), refer to the documentation on the pickup status bits on the storage device enclosed with the ignition controller. You can open the file via the menu: *Documentation -> More information*.

For a more in-depth analysis of the problem, the pickup traces may support you. Refer to the section *Pickup Trace* on page 74. Compare the signals recorded there with the pickup settings in your configuration (see *Engine – Pickups* on page 91).

10.2.5 Acknowledging Faults

While the engine is shut down, you have the following options for acknowledging operating errors:

- Use *Error Acknowledge* in the MICT
- Acknowledgment of the error via CAN bus or RS485
- By disconnecting the supply voltage

10.3 Troubleshooting

10.3.1 Running a Self Test

You can run the self test via the MICT to check the order of the wiring and the connection between the ignition controller outputs and the spark plugs. For this refer to section *Self Test* on page 72.



Operational safety!

If you carry out a self test, it is essential for the gas supply to be switched off and no more residual gas is left in the combustion chamber. Non-compliance can result in damage to equipment or injury to persons.

10.3.2 Customer Service Information

You can reach our customer service during business hours at the following phone and fax number, or by email:

Phone: +49 5141 93 99 0

Fax: +49 5141 93 99 99

Email: service@motortech.de

10 Errors

10.3.3 Returning Equipment for Repair / Inspection

To return the device for repair and inspection, obtain a return form from your MOTORTECH contact person (see *Customer Service Information* on page 159).

After you have completely filled out the return form and returned it to MOTORTECH, MOTORTECH will send you back the return form and a delivery note with RMA number specified. Enclose the return form with your device and attach the delivery note to the packaging so that it is clearly visible from the outside. This guarantees a fast and smooth processing of your repair order.

Send the device with delivery note and return form to one of the two addresses below or to the nearest MOTORTECH representative:

MOTORTECH GmbH

Hogrevestr. 21–23
29223 Celle

Germany

Phone: +49 5141 93 99 0

Fax: +49 5141 93 99 98

www.motortech.de

motortech@motortech.de

MOTORTECH Americas, LLC

1400 Dealers Avenue, Suite A
New Orleans, LA 70123

USA

Phone: +1 504 355 4212

Fax: +1 504 355 4217

www.motortechamericas.com

info@motortechamericas.com

10.3.4 Instructions for Packaging the Equipment

For return shipment, equipment should be packaged as follows:

- Use packaging material that does not damage the equipment surfaces.
- Wrap the equipment with sturdy materials and stabilize it inside the packaging.
- Use sturdy adhesive film to seal the packaging.

11.1 Maintenance Instructions

Please follow the following maintenance instructions:

- Do not use caustic liquids or steam cleaners for cleaning the device.
- Clean the passive pickups at regular intervals.
- Check the ignition wires at regular intervals.
- Replace the pickups at regular intervals if operating them under elevated temperature conditions ($> +90\text{ °C}$ / $> +194\text{ °F}$).
- Regularly inspect all wires of the ignition system for damage and replace the wires as needed.
- Check all plug-in connections for proper condition.
- Service the spark plugs as per the instructions of the spark plug and engine manufacturers.

11.2 Spare Parts and Accessories

For spare parts and accessories for MIC3+ ignition systems, please refer to our current product guide, which is available for download on the Internet at www.motortech.de.

12 Index

A	
Abbreviation	8
Access Control	
Activate	76
Device	76
Advanced service	
Access level	66
Alarm	
Acknowledge	123
Detail	128
Function	60
Overview	128
Alarm configuration	
View	101
Arrangement number	21
ASO	
Example.....	61
Function	61
Setting	103
Wiring	44
Auxiliary synchronization output	
Example.....	61
Function	61
Setting	103
Wiring	44
B	
Base timing	
Setting	97
C	
CAN bus	
Interface	25
Setting	106
Wiring	47
Coil type	
Setting	83
Coils.....	148
Configuration	
Download	78
Open	78
Upload	78
Current input	
Current value	113
Function	57
Setting	95, 97
Customer	
Access level	66
Cylinder name	86
D	
Declaration of conformity.....	18
Device	
Dimension	26
Disposal	16
Electrical data	21
Installation	31
Mechanical data.....	19
Return.....	160
Select type.....	79
Start-up	152
Switching off.....	153
Downgrade	
Process sequence.....	153
E	
Electrostatics	12
Energy	
Overview.....	115
Setting.....	99, 141
Energy limit	
Start phase	99
Engine	
Define.....	87
Selection	83
Setting.....	83
Engine database	83, 87
F	
Failure	
Acknowledge.....	68, 158
Logging	137
Overspeed	157
Overview.....	129
Pickups.....	158
View	123
Firing angle	
Calculation.....	59
Firmware	
Downgrade	153
Update.....	153
G	
General purpose output	
Function.....	61
Wiring.....	44
Go/NoGo output	
Function.....	55
Wiring.....	44

GPO		
Function.....	61	
Wiring.....	44	
H		
Hall effect sensor		
Supply voltage	91	
I		
Ignition coils		
Setting.....	89	
Wiring.....	50	
Ignition controller		
Dimension.....	26	
Disposal.....	16	
Electrical data	21	
Installation.....	31	
Mechanical data	19	
Return.....	160	
Select type	79	
Start-up	152	
Switching off	153	
Ignition Timing Adjustment		
Maximum	100	
Index		
Setting.....	91	
Information		
To device.....	136	
Input		
Electrical data	21	
Installation	31	
MICT	65	
L		
Log file		
Create.....	137	
M		
Menu		
MICT	68	
MIC3+		
Dimension.....	26	
Disposal.....	16	
Electrical data	21	
Installation.....	31	
Mechanical data	19	
Return.....	160	
Select type	79	
Start-up	152	
Switching off	153	
MICT		
Access level.....	66	
Design	67	
Installation	65	
Menu overview	68	
Operation	67	
Symbol overview.....	68	
System requirements	65	
Update	71	
Misfire rate		
Causes	158	
Misfiring		
Overview	115	
MOTORTECH		
Address.....	160	
MOTORTECH Integrated Configuration Tool		
Access level.....	66	
Design	67	
Installation	65	
Menu overview	68	
Operation	67	
Symbol overview.....	68	
System requirements	65	
Update	71	
N		
Nominal speed		
Setting	91	
O		
Operating data		
Overview	110	
Printing	109	
Operating hours		
Engine.....	110	
Set	68	
Spark plug.....	110	
Operating level		
Login.....	77	
Output		
Electrical data	21	
Overspeed		
Exceeded.....	157	
Setting	91	
P		
Parameter settings (schedule)		
Function	60	
Representation	147	
Setting	97, 99	
Simulation.....	145	

12 Index

Part number	21
Pickup input	
Setting	91
Pickup sensitivity	
Function	55
Setting	91
Pickups	
Calculate frequency	21
Check	55
Record	74
Setting	91
Supply voltage	91
Wiring	39
PIN	
Change	77
Reset	77
Potentiometer	
Current value	113
Setting	97
Power supply	
Analog inputs	95
Wiring	37
PowerView3	
Wiring	45
Pre-trigger voltage	
Setting	91
Printing	
Operating data	109
R	
Read only	
Access level	66
Regulations	
Overview	18
Repair	160
Required current	21
Reset	
Setting	139
Return shipment	160
RS485 Interface	
Wiring	49
S	
Safety device	
Wiring	41
Safety function	
Overview	157
Safety instructions	11, 15
Secondary voltage	
Secondary short detection	143
Secondary voltage estimation	142
Security speed	
Setting	91
Self Test	72, 159
Serial number	
Device	21
Service	
Access level	66
Service contact	
Setting	108
Shut off	153
Software	
Access level	66
Design	67
Installation	65
Menu overview	68
Operation	67
Symbol overview	68
System requirements	65
Update	71
Spark duration	
Overview	115
Setting	99
Spark plug hours	
Set	68
Speed	
Current value	110
Max. value	110
Speed curve	
Current value	113
Function	59
Setting	97
Speed limit	
Start phase	99
Start phase	
Energy limit	99
Speed limit	99
Starter speed	
Setting	91
Start-up	152
System state	
Overview	110
T	
Temperature	
Board	135
Timing	
Base	110, 113
Global	110, 113
Limits	97
Overview	113
Setting	140
Timing correction	
Current value	113
Function	59

Timing setup	
Wiring	41
U	
Update	
Process sequence	153
USB	
Connection	25
V	
Voltage input	
Current value	113
Function	57
Setting	95, 97
W	
Wiring	
Auxiliary synchronization output	44
CAN bus	47
Direct	52, 83
General purpose output	44
Go/NoGo output	44
Pickups	39
Power supply	37
PowerView3	45
Safety device	41
Timing setup	41

MOTORTECH GmbH

Hogrevestr. 21–23
29223 Celle
Germany

Phone: +49 (5141) 93 99 0
Fax: +49 (5141) 93 99 99
E-Mail: sales@motortech.de
Web: www.motortech.de

MOTORTECH Americas, LLC

1400 Dealers Avenue, Suite A
New Orleans, LA 70123
USA

Phone: +1 (504) 355 4212
Fax: +1 (504) 355 4217
E-Mail: info@motortechamericas.com
Web: www.motortechamericas.com

MOTORTECH Shanghai Co. Ltd.

Room 1018 Enterprise Square,
No. 228 Meiyuan Road,
Jing'An District, 200070 Shanghai
China

Phone: +86 (21) 6380 7338
E-Mail: info@motortechshanghai.com
Web: www.motortechshanghai.com

GAS ENGINE TECHNOLOGY

Ignition Systems	Red
Spark Plugs & Accessories	Orange
Gas Engine Control Systems	Light Blue
Sensor Systems	Yellow
Air/Fuel Ration Control Systems	Green
Exhaust Gas Aftertreatment	Green
Gas Engine Accessories	Grey