

# PowerView3 – HMI Module

## Operating Manual

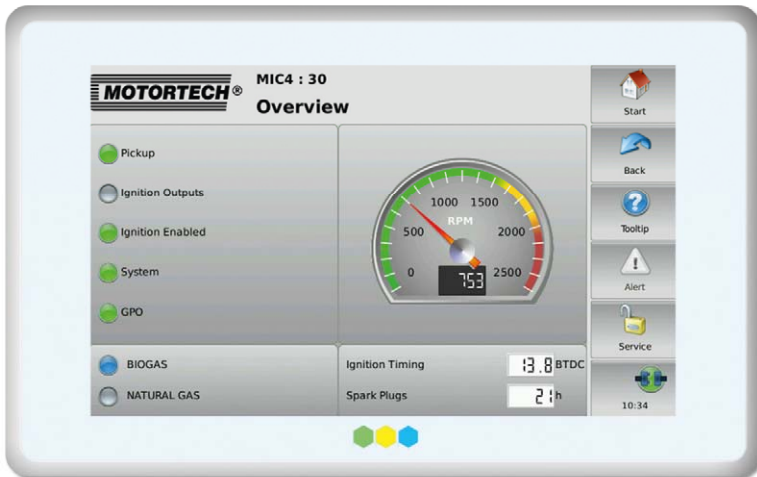

P/N 01.10.015-EN | Rev. 02/2018

### Copyright

© Copyright 2018 MOTORTECH GmbH. All rights reserved.

Distribution and reproduction of this publication or parts thereof, regardless of the specific purpose and form, are not permissible without express written approval by MOTORTECH. Information contained in this publication may be changed without prior notice.

### Trademarks

MOTORTECH products and the MOTORTECH logo are registered and/or common law trademarks of the MOTORTECH Holding GmbH. All further trademarks and logos displayed or used in this publication are the property of the respective entitled person.

# Table of Contents



<b>1 General Information</b> .....	<b>6</b>
1.1 What Is the Purpose of this Operating Manual? .....	6
1.2 Who Is this Operating Manual Targeted to? .....	6
1.3 Which Symbols Are Used in the Operating Manual? .....	6
1.4 Which Abbreviations/Acronyms Are Used in the Operating Manual? .....	7
<b>2 Safety Instructions</b> .....	<b>10</b>
2.1 General Safety Instructions .....	10
2.2 Electrostatic Discharge Hazards .....	11
2.3 Special Safety Instructions for the Device .....	12
2.4 Proper Disposal.....	13
<b>3 Intended Use</b> .....	<b>14</b>
3.1 Functional Description .....	14
3.2 Applications.....	14
3.3 Use in Potentially Explosive Atmospheres .....	14
<b>4 Product Description</b> .....	<b>15</b>
4.1 Technical Data .....	15
4.1.1 Certifications .....	15
4.1.2 Mechanical Data .....	20
4.1.3 Warning Notices on the Device.....	21
4.1.4 Product Identification – Labeling on the Device.....	22
4.1.5 Electrical Data.....	23
4.1.6 Display.....	23
4.1.7 Interfaces .....	24
4.1.8 Overview Drawings .....	26
<b>5 Operation</b> .....	<b>28</b>
5.1 Start-up.....	28
5.2 Shutdown .....	28
5.3 Software Updates .....	29
<b>6 Installation Instructions</b> .....	<b>32</b>
6.1 Unpacking.....	32
6.2 Installation .....	33
<b>7 Wiring of the Device</b> .....	<b>35</b>
7.1 CAN Bus Wiring .....	35
7.2 Binary Inputs/Outputs .....	42
7.3 Power Supply .....	43

# Table of Contents

<b>8 General Operation .....</b>	<b>45</b>
8.1 Switching on and off the Device.....	45
8.2 Navigation .....	46
8.3 Menu Bar.....	47
8.4 Start Menu.....	49
8.4.1 Devices .....	51
8.4.1.1 Device Type Activation .....	52
8.4.1.2 Adding a Device .....	53
8.4.1.3 Editing a Device .....	55
8.4.1.4 Deleting a Device .....	55
8.4.1.5 Logging Device Data.....	55
8.4.1.6 Device Type Generic.....	56
8.4.2 Display .....	57
8.4.3 Connection .....	60
8.4.4 Recordings .....	62
8.4.4.1 Displaying Recordings.....	63
8.4.4.2 Processing Data on the PC .....	64
8.5 Access Control .....	65
8.5.1 Enabling/Disabling Access Control .....	66
8.5.2 Minimum Level.....	68
8.5.3 Logging in and Logging out .....	68
8.5.4 Changing the PIN.....	70
8.5.5 Resetting the PINs .....	70
8.6 Event Log.....	72
8.7 Help .....	73
<b>9 Devices.....</b>	<b>74</b>
9.1 MIC Ignition Controller.....	74
9.1.1 Main Menu.....	74
9.1.2 Overview .....	76
9.1.3 Timing.....	78
9.1.4 Ignition .....	79
9.1.5 Energy.....	82
9.1.6 Firing Angles .....	82
9.1.7 Adjustments .....	85
9.1.8 Trends .....	93
9.1.9 Message Log .....	96
9.1.10 Diagnosis .....	98
9.1.11 Information .....	99

<b>9.2 DetCon Detonation Controller</b> .....	<b>101</b>
<b>9.2.1 Main Menu</b> .....	<b>101</b>
<b>9.2.2 Overview</b> .....	<b>102</b>
<b>9.2.3 Intensity</b> .....	<b>104</b>
<b>9.2.4 Trends</b> .....	<b>105</b>
<b>9.2.5 Preferences</b> .....	<b>108</b>
<b>9.3 TempScan Temperature Module</b> .....	<b>110</b>
<b>9.3.1 Main Menu</b> .....	<b>110</b>
<b>9.3.2 Overview</b> .....	<b>112</b>
<b>9.3.3 Preferences</b> .....	<b>113</b>
<b>9.3.3.1 Names</b> .....	<b>114</b>
<b>9.3.3.2 Groups</b> .....	<b>116</b>
<b>9.3.3.3 Channels</b> .....	<b>117</b>
<b>9.3.3.4 Type</b> .....	<b>120</b>
<b>9.3.3.5 Activation</b> .....	<b>121</b>
<b>9.3.3.6 Thresholds</b> .....	<b>122</b>
<b>9.3.3.7 Internal Status</b> .....	<b>124</b>
<b>9.3.4 Group-Specific Views</b> .....	<b>125</b>
<b>9.3.4.1 Overview</b> .....	<b>126</b>
<b>9.3.4.2 Temperatures</b> .....	<b>127</b>
<b>9.3.4.3 Average Deviation</b> .....	<b>128</b>
<b>10 Errors</b> .....	<b>129</b>
<b>10.1 Possible Faults</b> .....	<b>129</b>
<b>10.2 Customer Service Information</b> .....	<b>131</b>
<b>10.3 Returning Equipment for Repair / Inspection</b> .....	<b>131</b>
<b>10.4 Instructions for Packaging the Equipment</b> .....	<b>131</b>
<b>11 Maintenance</b> .....	<b>132</b>
<b>11.1 Changing the Battery</b> .....	<b>132</b>
<b>11.2 Cleaning the Touchscreen</b> .....	<b>134</b>
<b>12 Index</b> .....	<b>135</b>

# 1 General Information

Read through this operating manual carefully before use and become familiar with the product. Installation and start-up should not be carried out before reading and understanding this document. Keep this manual readily available so that you can reference it as needed.

## 1.1 What Is the Purpose of this Operating Manual?

This manual serves as an aid for the installation and operation of the product and supports the technical staff with all operating and maintenance tasks to be performed. Furthermore, this manual is aimed at preventing dangers to life and health of the user and third parties.

## 1.2 Who Is this Operating Manual Targeted to?

The operating manual provides a code of conduct for personnel tasked with the setup, operation, maintenance, and repair of gas engines. A certain level of technical knowledge with respect to the operation of gas engines and basic knowledge of electronic ignition systems are necessary. Persons who are only authorized to operate the gas engine shall be trained by the operating company and shall be expressly instructed concerning potential hazards.

## 1.3 Which Symbols Are Used in the Operating Manual?

The following symbols are used in this manual and must be observed:



### Example

This symbol indicates examples, which point out necessary handling steps and techniques. In addition, you receive additional information from the examples, which will increase your knowledge.



### Notice

This symbol indicates important notices for the user. Follow these. In addition, this symbol is used for overviews that give you a summary of the necessary work steps.



### Warning

This symbol indicates warnings for possible risks of property damage or risks to health. Read these warning notices carefully and take the mentioned precautionary measures.



## Danger

This symbol indicates warnings for danger to life, especially due to high voltage. Read these warning notices carefully and take the mentioned precautionary measures.

## 1.4 Which Abbreviations/Acronyms Are Used in the Operating Manual?

In the manual or the user interface, the following abbreviations / acronyms are used.

Abb.	Term	Description	Explanation
ADC	Analog-to-Digital Converter		Component that converts analog input signals into digital signals.
ATDC	After Top Dead Center		
BTDC	Before Top Dead Center		
CAN bus	Controller Area Network bus	Bus for control devices / networks	Asynchronous serial connection system for linking control units
CE	Conformité Européenne	Conformity with EU directives	Mark based on EU legislation for certain products in conjunction with product safety
CR	Contrast Ratio		
°crank-shaft	Degree crankshaft		Unit for the rotation angle of the crankshaft
CSA	Canadian Standards Association		Organization that defines standards, inspects products for safety compliance, and issues pertinent certifications.
DC	Direct Current		
DetCon	Detonation Control System		Serves to prevent major engine damage that can be caused by knocking combustion.
EEPROM	Electrically Erasable Programmable Read-Only Memory		Non-volatile electronic memory module whose stored information can be deleted electrically.

# 1 General Information

Abb.	Term	Description	Explanation
EMC	Electromagnetic Compatibility		Compatibility of electrical or electronic equipment items with their surroundings
GPI	General Purpose Input	Multi-purpose input	
GPO	General Purpose Output		
HMI	Human-Machine Interface		Interface between a human and a machine or a computer
IO	Input/Output		
ISO	International Organization for Standardization		
LED	Light Emitting Diode		Light emitting electronic semiconductor
LSS	Layer Setting Services		Service for configuration of node ID and bit rate in a CANopen® network
MIC	MOTORTECH Ignition Controller		
MICT	MOTORTECH Integrated Configuration Tool		Software for configuring MOTORTECH ignition controllers
NMT	Network Management		
PRAK	PIN Reset Authorization Key	Key for resetting all PINs	Key that resets all PINs of the PowerView3.
PRRK	PIN Reset Request Key	Key for applying for a PIN reset key	Key with which the key for resetting all PowerView3 PINs can be requested.
RoHS	Restriction of Hazardous Substances		
RS485	Recommended Standard 485		Industrial standard for a physical interface for asynchronous serial data transfer
SD card	Secure Digital card	Secure digital data storage medium	Digital storage medium



# 1 General Information



Abb.	Term	Description	Explanation
SDHC card	Secure Digital High-Capacity card	Secure, high-capacity digital memory card	Digital storage medium
SELV	Safety Extra-Low Voltage		
SPI	Serial Peripheral Interface		Bus system for a synchronous serial data bus
TFT	Thin-Film Transistor		Control technology for liquid crystal flat screens
TN	Twisted Nematic		Orientation type of liquid crystals in flat panel displays
USB	Universal Serial Bus		Serial connection system to link a computer to external devices
XML	Extensible Markup Language		Markup language for displaying hierarchically structured data

## 2 Safety Instructions

### 2.1 General Safety Instructions

The following safety instructions must be followed in the area in which the device is operated:



#### High voltage! Danger to life!

While the engine is running, the area around the ignition system especially holds the risk of danger due to high voltage. The following parts should therefore not be touched or removed unless explicitly stated otherwise:

- Ignition coils and caps
- Wires of the high voltage circuit
- In- and output wiring of the ignition controller
- Pickups and their wiring



#### Danger to persons with pacemakers!

Electromagnetic impulses in the wiring of the ignition system may exceed the permissible limits of pacemakers. Persons with pacemakers must therefore not be present in the vicinity of the ignition system being operated. Mark the operating location of the ignition system with the corresponding standardized warning symbol.

MOTORTECH equipment is manufactured as state of the art and therefore safe and reliable to operate. Nevertheless the equipment can cause risks or damage can occur, if the following instructions are not complied with:

- The gas engine must only be operated by trained and authorized personnel.
- Operate the equipment only within the parameters specified in the technical data.
- Use the equipment correctly and for its intended use only.
- Never apply force.
- For all work such as installation, conversion, adaptation, maintenance, and repair, all equipment must be disconnected from the mains and secured against unintentional reactivation.
- Perform only such maintenance and repair work as is described in this operating manual, and follow the instructions given while working. For maintenance of the equipment, only use spare parts supplied by MOTORTECH. Further work must only be performed by personnel authorized by MOTORTECH. Non-compliance with the instructions will void any warranties for the proper function of the equipment as well as the responsibility for the validity of the certifications.
- Safety devices must not be dismantled or disabled.
- Avoid all activities that can impair the function of the equipment.

## 2 Safety Instructions



- Operate the equipment only while it is in proper condition.
- Investigate all changes detected while operating the gas engine or ignition system.
- Ensure compliance with all laws, directives and regulations applicable to the operation of your system, including such not expressly stated herein.
- If the system is not entirely tight and sealed, gas may escape and result in explosion hazard. The inhalation of gas can also lead to death or severe health damages. Therefore, upon completion of all assembly works, always check the system's tightness.
- Always ensure adequate ventilation of the engine compartment.
- Ensure a safe position at the gas engine.

### 2.2 Electrostatic Discharge Hazards

Electronic equipment is sensitive to static electricity. To protect these components from damage caused by static electricity, special precautions must be taken to minimize or prevent electrostatic discharge.

Observe these safety precautions while you work with the equipment or in its vicinity.

- Before performing maintenance or repair work, ensure that the static electricity inherent to your body is discharged.
- Do not wear clothing made from synthetic materials to prevent static electricity from building up. Your clothing should therefore be made of cotton or cotton mix materials.
- Keep plastics such as vinyl and Styrofoam materials as far away from the control system, the modules, and the work environment as possible.
- Do not remove the circuit boards from the housing of the device.

## 2 Safety Instructions

### 2.3 Special Safety Instructions for the Device



#### **Explosion hazard!**

The following operations may only be executed providing the environment is classified as non-explosive:

- Establishing and terminating communications via PowerView3 interfaces and connections.
- Inserting and removing SD cards.



#### **Risk of destruction and injury!**

The PowerView3 is an electrically operated device and there is the risk of electrostatic discharges. Therefore, never operate the device without the appropriate grounding, to prevent injuries and damage.



#### **Risk of destruction!**

It is possible to damage the ignition kit and engine through PowerView3 settings. Consequently, protect your device against unauthorized access.

- Enable access control.
- Log out after using the access level employed.



#### **Risk of destruction!**

When using the PowerView3, observe the following points:

- Do not let the device fall.
- The device must not come into contact with water and other liquids.
- Do not operate the device in direct sunlight, near heat sources or in humid environments.
- Only operate the device according to the technical specifications.

Disregard of these guidelines can lead to the destruction of the device.



### **Risk of destruction!**

The surface of the touchscreen is sensitive to pointed and sharp-edged objects. Therefore handle the touchscreen carefully. Pixel errors due to improper handling are excluded from the warranty.



### **Risk of damage and malfunctions!**

Safe operation is no longer guaranteed in the following cases:

- The product shows visible damage.
- The display remains dark or shows unusual patterns for a longer period of time.
- The screen saver does not turn off when touching the display.
- The device does not react after a restart.

The PowerView3 must then be turned off and must not be used any longer.



### **Operational safety!**

The PowerView3 and the software are not designed for safety-critical applications. The binary inputs and outputs of the PowerView3 must not be used for safety-critical purposes.

## **2.4 Proper Disposal**

After the expiration of its service life, MOTORTECH equipment can be disposed of with other commercial waste, or it may be returned to MOTORTECH. We will ensure its environmentally friendly disposal.

## 3 Intended Use

### 3.1 Functional Description

The PowerView3 is used to visualize and record engine operating data. The data can be provided by the following MOTORTECH devices that are connected via a CAN bus:

- Ignition controller MIC3, MIC3+, MIC4, MIC4+, MIC5, MIC5+
- Detonation controller DetCon2, DetCon16, DetCon20
- Temperature module TempScan20

Several settings of the ignition controllers can be changed via the PowerView3. The TempScan20 temperature module is fully configurable via the PowerView3. If warnings and errors occur in the DetCon detonation controller or the TempScan temperature module, two binary outputs can be switched at the PowerView3. A slot for SD cards and a USB port permit saving recorded data on a storage device.

The PowerView3 functions as NMT master in the CANopen® network. Simultaneously, the PowerView3 can integrate a maximum of one ignition controller, one detonation controller and three temperature modules. In addition, you can monitor the connection status of up to three devices which are not directly supported by the PowerView3. These devices are then started automatically during PowerView3 start-up.

### 3.2 Applications

The PowerView3 must only be operated in a control cabinet and with the devices specified for this purpose. The PowerView3 does not support safety-critical applications.

Any use other than the one described in the operating manual shall be considered improper use and will result in the voiding of all warranties.

### 3.3 Use in Potentially Explosive Atmospheres

The PowerView3 is certified by the CSA for use in a Class I, Division 2, Groups C and D, T4 hazardous location in the USA and Canada. For this, you must adhere to the information of the CSA certificate 2173514 (see section *Certifications* on page 15).

## ■ 4 Product Description



### 4.1 Technical Data

#### 4.1.1 Certifications

The PowerView3 is certified in compliance with the following regulations:

##### CSA

- Class I, Div 2, Groups C, D, T4
- CSA Std C22.2 No. 0 -10
- CSA Std C22.2 No. 142-M1987 (R 2004)
- CSA Std C22.2 No. 213-M1987 (R 2004)
- ANSI/ISA 12.12.01, Ed 1 (2007)
- UL Std No. 916, Ed 3 (1998)

##### CE

- EMC Directive 2014/30/EU
  - Immunity characteristics according to EN 55024:2010
  - Emission according to EN 55032:2012
- RoHS Directive 2011/65/EC
  - Technical documentation for the assessment of electrical and electronic products with respect to the restriction of hazardous substances according to EN 50581:2012

## 4 Product Description



# Certificate of Compliance

**Certificate:** 2173514 (LR 211392)

**Master Contract:** 211392

**Project:** 2650124

**Date Issued:** June 20, 2014

**Issued to:** Motortech GmbH  
Hogrevestrasse 21-23  
Celle, 29223  
Germany  
Attention: Rainer Voelz

*The products listed below are eligible to bear the CSA Mark shown with adjacent indicators 'C' and 'US' for Canada and US or with adjacent indicator 'US' for US only or without either indicator for Canada only.*



**Issued by:** Marin Bantu, P. Eng.

### PRODUCTS

**CLASS 2258 02** - PROCESS CONTROL EQUIPMENT - For Hazardous Locations

**CLASS 2258 82** - PROCESS CONTROL EQUIPMENT - For Hazardous Locations -  
Certified to US Standards

Class I, Div 2, Groups C and D, T4.

- PowerView 2 Series of Engine Information Monitor, input ratings: 24Vdc, 1.8 A; Ambient temperature range 0°C to +50°C.

Notes: 1. This unit must be supplied by a SELV-circuit.

2. The unit is certified to be installed on a Control Panel in accordance to the CEC and NEC wiring method.
3. The final installation of the PowerView 2 on Control Panel shall meet the requirements for IP65/Type 4 Encl.
4. The USB and LAN interface connectors are only to be used in areas known to be non-hazardous.



## 4 Product Description



**Certificate:** 2173514 (LR 211392)

**Master Contract:** 211392

**Project:** 2650124

**Date Issued:** June 20, 2014

- PowerView 3 Series of Engine Information Monitor, input ratings: 214mA@24V max 7 Watt; Ambient temperature range 0°C to +60°C.

Notes: 1. This unit must be supplied by a SELV-circuit.

2. The unit is certified to be installed on a Control Panel in accordance to the CEC and NEC wiring method.
3. The final installation of the PowerView 2 on Control Panel shall meet the requirements for IP65/Type 4 Encl.
4. The USB and LAN interface connectors are only to be used in areas known to be non-hazardous.

### **APPLICABLE REQUIREMENTS**

- CSA Std C22.2 No. 0-10 - General Requirements – Canadian Electrical Code – Part II
- CSA Std C22.2 No. 142-M1987 (R 2004) - Process Control Equipment
- CSA Std C22.2 No. 213-M1987 (R 2004) - Non-Incendive Electrical Equipment for Use in Class I, Division 2 Hazardous Locations
- ANSI/ISA 12.12.01, Ed 1 (2007) - Nonincendive Electrical Equipment for Use in Class I and II, Division 2 and Class III, Division 1 and 2 Hazardous (Classified) Locations
- UL Std No. 916, Ed 3 (1998) - Energy Management Equipment

### **MARKINGS**

- CSA Monogram with “C” and “US” indicators
- Master contract number or manufacturer name
  - Model name or number (“A010301” for PowerView 2/ “B010301” for PowerView 3)
  - Serial number or Date of manufacturing
  - Electrical Ratings
  - Hazardous Location Designation: Class I, Division 2, Groups C and D;
  - Temperature Code

## 4 Product Description



**Certificate:** 2173514 (LR 211392)

**Master Contract:** 211392

**Project:** 2650124

**Date Issued:** June 20, 2014

- 
- Maximum Ambient Temperature
  - Warning re. substitution of components
  - Text: "EXPLOSION HAZARD! Do not disconnect while circuit is live unless area is known to be non-hazardous."

*Note - Jurisdictions in Canada may require these markings to also be provided in French language. It is the responsibility of the manufacturer to provide bilingual marking, where applicable, in accordance with the requirements of the Provincial Regulatory Authorities. It is the responsibility of the manufacturer to determine this requirement and have bilingual wording added to the "Markings".*

### EU-Konformitätserklärung

EU Declaration of Conformity



Die Firma:  
The company:

**MOTORTECH GmbH**  
**Hogrevestr. 21–23**  
**29223 Celle**  
**Deutschland (Germany)**

erklärt in alleiniger Verantwortung, dass das Produkt:  
declares in sole responsibility that the product:

**PowerView3-HMI-Modul**  
PowerView3 HMI Module

Verwendungszweck:  
intended purpose:

**Anzeigeeinheit für MOTORTECH-Geräte**  
Display unit for MOTORTECH devices

übereinstimmt mit den Bestimmungen folgender EU-Richtlinien:  
complies with the provisions of the following EU Directives:

**EMV-Richtlinie 2014/30/EU**  
EMC Directive 2014/30/EU

**RoHS-Richtlinie 2011/65/EU**  
RoHS Directive 2011/65/EU

unter Berücksichtigung folgender Normen:  
under consideration of the following standards:

**EN 55024:2010**  
**EN 55032:2012**  
**EN 50581:2012**

Die Kennzeichnung des Produktes ist:  
The marking of the product is:

**P/N 06.05.085**

Diese Erklärung wird abgegeben durch:  
This declaration is submitted by:

Name: Florian Virchow

Stellung im Unternehmen: Geschäftsführer  
Position in company: Managing Director

Celle, 2017-08-03

Ort, Datum  
Place, date

rechtsverbindliche Unterschrift  
Legally binding signature

## 4 Product Description

### 4.1.2 Mechanical Data

The PowerView3 has the following mechanical characteristics.

Feature	Value
Dimensions	207 mm x 126.1 mm x 29.5 mm (8.15" x 4.96" x 1.16") (length x width x height)
Weight	670 g (1.48 lbs)
Shape of device	See section <i>Overview Drawings</i> on page 26
Noise level	Fanless design
Mechanical environmental conditions	Protection class: IP20 (entire device), IP64 (cover glass)
Climatic environmental conditions	Operation: 0 °C to +60 °C (+32 °F to +140 °F) up to 3,000 m (9,842') above sea level Storage: -20 °C to +70 °C (-4 °F to +158 °F) up to 10,000 m (32,808') above sea level 5 % to 90 % humidity without condensation

## 4 Product Description



### 4.1.3 Warning Notices on the Device



#### Validity of warning notices on device

The warning notices on the device are valid for the PowerView3 and all components connected to it.



**PowerView3**  
MOTORTECH ENGINE INFORMATION MONITOR

Electrical Rating: Input 24 VDC • max. 7.0 W  
Ambient Temperature: 0° C to +60° C max.  
32° F to +140° F max.

**EXPLOSION HAZARD!** Do not disconnect while circuit is live unless area is known to be non-hazardous. For wiring details please refer to operating manual.

**WARNING!** Read and understand the installation and operating manual prior to installing or making any adjustments.

www.mortortech.de



Class I, Division 2, Group C, D; T4  
Master Contract 211392



#### English warning notice on the device

**EXPLOSION HAZARD!** Do not disconnect while circuit is live unless area is known to be non-hazardous. For wiring details refer to the operating manual.

**WARNING!** Read and understand the installation and operating manual prior to installing or making any adjustments.

#### French translation

**RISQUE D'EXPLOSION!** Ne débranchez pas lorsque le circuit est sous tension sauf si la zone est connue pour être non dangereux. Pour plus de détails de câblage, veuillez consulter le manuel d'utilisation.

**ATTENTION!** Avant d'installer ou d'effectuer une modification, lisez et comprenez le manuel d'utilisation et d'installation.

## 4 Product Description

### 4.1.4 Product Identification – Labeling on the Device

On the back of the PowerView<sub>3</sub> there is a sticker with the following information:

HMI Module		Activation Code	
P/N	06.05.085	P/N	06.05.086-F Ignition Control <input type="checkbox"/>
A/N	PV3.00.0000-000-AA-A	P/N	06.05.087-F Detonation Control <input type="checkbox"/>
S/N	01XXXXXX	P/N	06.05.088-F Temperature Control <input type="checkbox"/>

#### HMI Module

- P/N: Part number
- A/N: Arrangement number
- S/N: Serial number

#### Activation Code

This section informs you with which activation codes for the visualization of device types the PowerView<sub>3</sub> was delivered.

- Ignition Control: Ignition controllers MIC<sub>3</sub>, MIC<sub>3+</sub>, MIC<sub>4</sub>, MIC<sub>4+</sub>, MIC<sub>5</sub>, and MIC<sub>5+</sub>
- Detonation Control: Detonation controllers DetCon<sub>2</sub>, DetCon<sub>16</sub>, and DetCon<sub>20</sub>
- Temperature Control: Temperature module TempScan<sub>20</sub>

You can obtain activation codes that were not part of the scope of supply of your PowerView<sub>3</sub> from MOTORTECH (see section *Customer Service Information* on page 131).

## 4 Product Description



### 4.1.5 Electrical Data

The PowerView3 has the following electrical characteristics:

Feature	Value
Power consumption	4.5 W typical, max. 7 W
Power supply	Nominal voltage: 24 V DC Operating voltage: 9 V DC to 30 V DC
Required current	250 mA at 24 V typical
Real-time clock accuracy	Depending on ambient temperature ± 30 ppm at 25 °C (77 °F)
Internal backup battery	Type: CR2032 (3 V, Li-Ion) Service life: >10 years (depending on application)

### 4.1.6 Display

The PowerView3 display has the following features:

Feature	Value
Screen diagonal	178 mm (7")
Display technology	TFT TN
Backlight unit	LED
Resolution	800 x 480 pixels
Color depth	18 bit (262,144 colors)
Brightness	400 cd/m <sup>2</sup>
Viewing angle	Typical 70/70/60/60 (L/R/U/D) at CR > 10
Touch technology	4-wire resistive
Surface treatment	Antiglare, hard coating (3H)

## 4 Product Description

### 4.1.7 Interfaces



#### Use in potentially explosive atmospheres

For use in a hazardous area of Class I, Division 2, Groups C and D, T<sub>4</sub> in the USA and Canada, it is imperative that you observe the information of the CSA Certificate 2173514 (see section *Certifications* on page 15) for the PowerView<sub>3</sub>.

The PowerView<sub>3</sub> has the following interfaces:

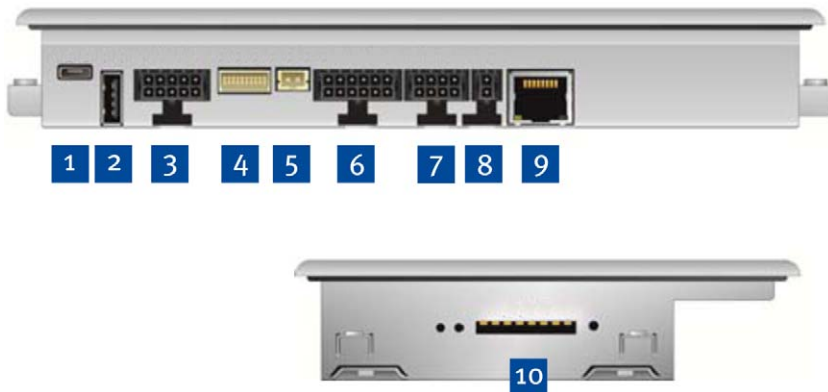

Item no.	Type	Properties
1	MicroUSB 2.0	No function
2	USB 2.0	12 Mbit/s Host
3	Serial interface	no function
4	SPI/Keypad	No function
5	Audio	No function
6	Field bus	Galvanically isolated 1x CAN (ISO/DIS 11898) 1x RS485 (no function)
7	Binary inputs and outputs	Galvanically isolated 2 inputs (no function) 2 outputs: switching capacity 0.7 A



## 4 Product Description



Item no.	Type	Properties
8	Power	9 V DC to 30 V DC, nominal voltage 24 V DC
9	Network	No function
10	Memory card slots	Suitable for <ul style="list-style-type: none"><li>– SD cards up to 2 GB</li><li>– SDHC cards up to 32 GB</li></ul>

## 4 Product Description

### 4.1.8 Overview Drawings

Rear View

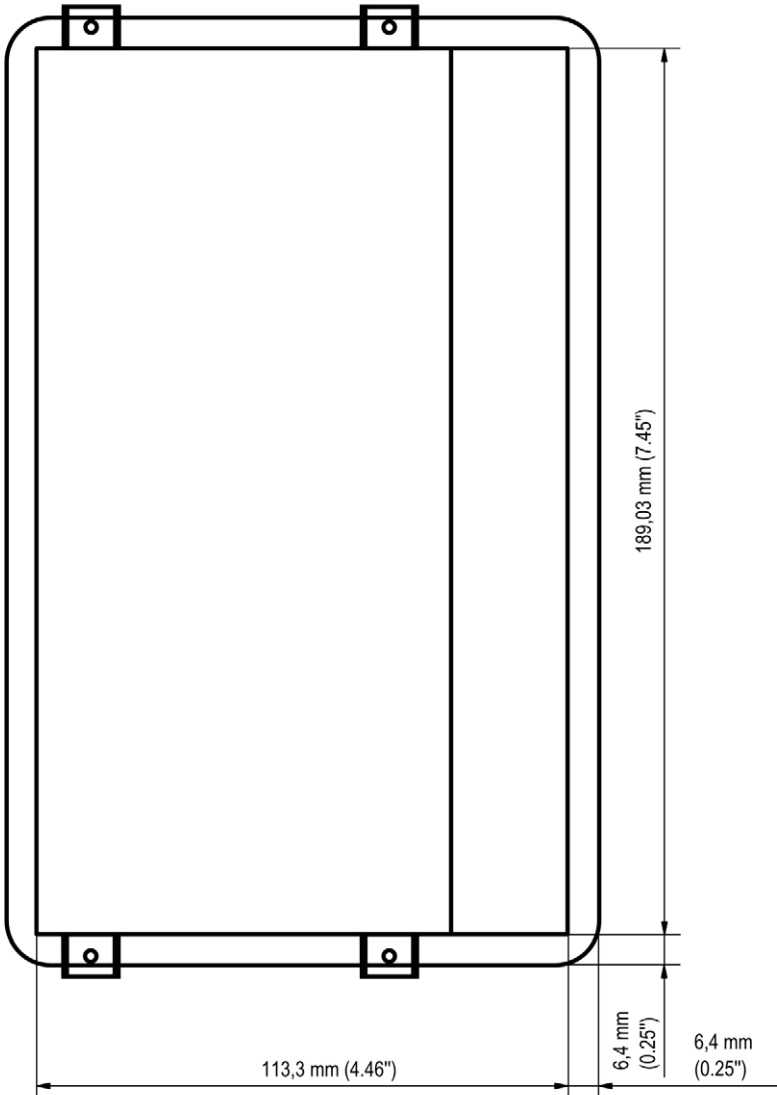

# 4 Product Description



Plan View

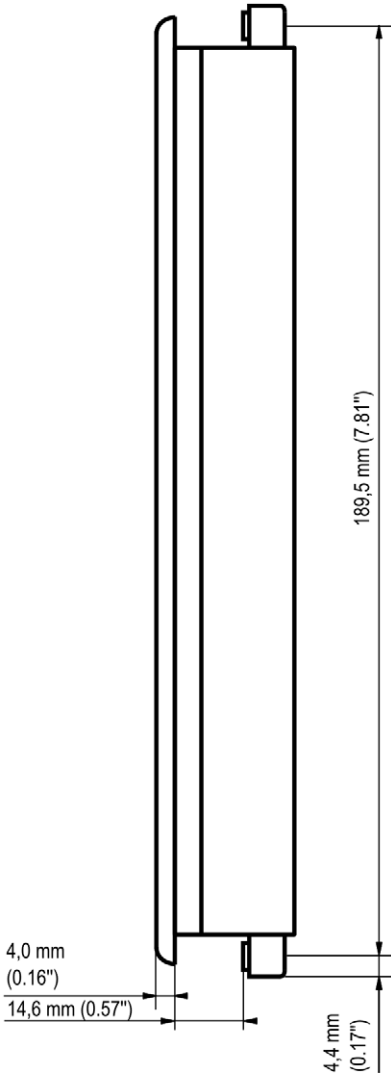

Side View

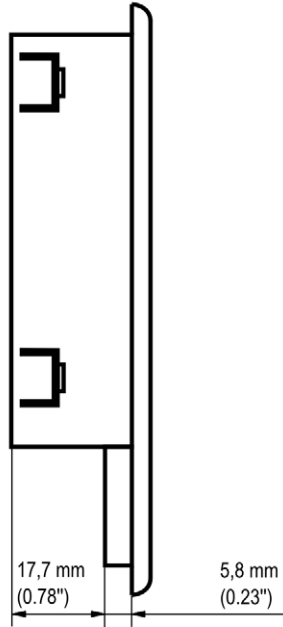

## 5 Operation

### 5.1 Start-up



#### Use in potentially explosive atmospheres

For use in a hazardous area of Class I, Division 2, Groups C and D, T<sub>4</sub> in the USA and Canada, it is imperative that you observe the information of the CSA Certificate 2173514 (see section *Certifications* on page 15) for the PowerView3.

Start up the device as follows:

1. Install the device into a control cabinet with a second person (see section *Installation* on page 33).
2. Connect the device to the CAN bus (see section *CAN Bus Wiring* on page 35).
3. If needed, wire the binary outputs of the PowerView3 (see section *Binary Inputs/Outputs* on page 42).
4. If needed, insert a USB flash drive into the USB 2.0 connection of the PowerView3 or insert the supplied SD card or another suitable SD card into the memory card slot of the PowerView3 (see *Interfaces* on page 24).
5. Establish the power supply (see section *Power Supply* on page 43).
  - ▶ The PowerView3 starts automatically after establishing the power supply.

### 5.2 Shutdown

Shut down the device as follows:

1. Interrupt the power supply to the PowerView3 (see section *Power Supply* on page 43). Files on the PowerView3 will not be damaged by this.
  - ▶ The PowerView3 switches off automatically after interruption of the power supply.
2. If necessary, remove the wiring of the binary outputs from the PowerView3 (see section *Binary Inputs/Outputs* on page 42).
3. Separate the device from CAN bus (see section *CAN Bus Wiring* on page 35).
4. If necessary, remove USB flash drive and SD card.
  - ▶ You can dismount the device from the control cabinet with a second person (see section *Installation* on page 33).

## 5.3 Software Updates



### **Risk of software damage!**

The power supply must not be interrupted under any circumstances during the software update. Otherwise, this can lead to serious errors and the PowerView3 will no longer work.



### **Back up activation codes and configuration**

Before updating the software, back up the activation codes of the activated device types (see section *Devices* on page 51) and the PowerView3 configuration (see section *Display* on page 57).

You receive software updates for the PowerView3 from MOTORTECH. A software update consists of several update files with signature files for verification of the update files. You need a USB flash drive to install updates. The current software version of your PowerView3 is displayed in the *Display Information* view (see section *Display* on page 57).

## 5 Operation



### Software version PowerView3 lower than 1.6.0: Update installer

If your PowerView3 has a software version lower than 1.6.0 installed, first update the installer on your PowerView3 before performing a software update. Proceed as follows:

1. Make sure that the installer file *ins-x.x.x-BSP-y.y.y.tar.bz2* corresponds to the board support package of your PowerView3. In the file name of the installer file you can identify the board support package by the version number after BSP (e. g. *1.41.0*).
2. Save the installer file *ins-x.x.x-BSP-y.y.y.tar.bz2* and the corresponding signature file with the extension *.sha1* in the root directory of a USB flash drive.
3. Insert the USB flash drive into your running PowerView3.
  - ▶ After a few seconds, the standard PowerView3 interface closes and an update dialog opens.
4. Available update files are displayed successively. Decline updates until the desired installer file *ins-x.x.x-BSP-y.y.y.tar.bz2* is displayed. Confirm the installation of this file.
  - ▶ After a short verification, the installer file is installed.
  - ▶ The installation is completed as soon as you see the standard PowerView3 interface.
5. Remove the USB flash drive from the PowerView3.
  - ▶ The installer on your PowerView3 has been updated. For a software update of the PowerView3, you can now proceed according to the standard instructions described below.

Perform updates as follows:

1. Read and observe all information provided with the update (e. g. README file).
2. Make sure that the update files correspond to the board support package of your PowerView3. The *Display Information* view (see section *Display* on page 57) displays the installed board support package of your PowerView3. In the file name of the update files you can identify the board support package by the version number after *BSP* (e. g. *1.41.0*).
3. Save the update files with the extension *.tar.bz2* and the corresponding signature files with the extension *.sha1* in the root directory of a USB flash drive.

4. Insert the USB flash drive into your running PowerView3.
  - ▶ After a few seconds, the standard PowerView3 interface closes and the installer interface opens.

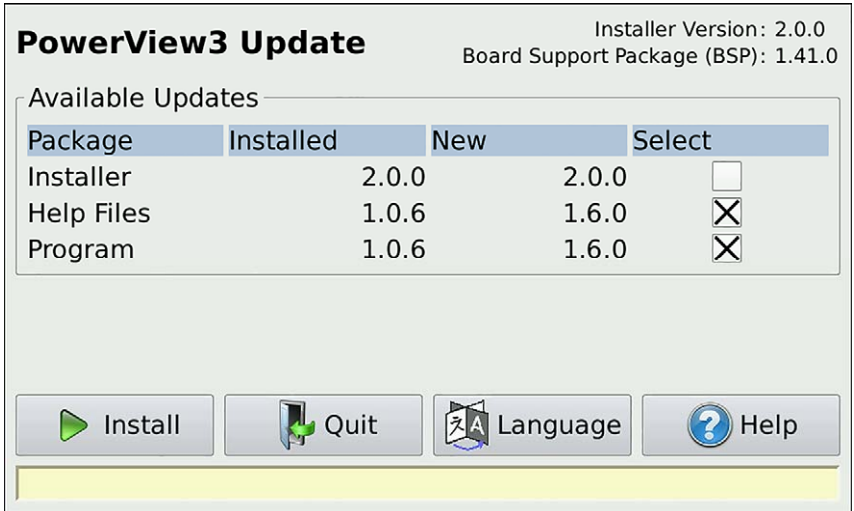

5. Available update packages are displayed in the *Package* column. If necessary, tap on the *Language* button to change the language. Under *Installed* the version of the respective package installed on the PowerView3 is displayed, under *New* the version to which the respective package in the PowerView3 will be updated. As a rule, the suitable update packages are preselected. To change the selection if needed, activate or deactivate the checkbox under *Select* for the respective packages. To install the selected packages, tap *Install*.
  - ▶ The selected update packages are installed. After an installer update, the installation of the remaining packages must be restarted by tapping the *Install* button.
  - ▶ Certain update packages may require a restart of the PowerView3.
6. After installing the desired update packages, exit the installer by tapping the *Quit* button and remove the USB flash drive.
  - ▶ You can now use the PowerView3 with the new software.

# 6 Installation Instructions

## 6.1 Unpacking

Unpack the equipment, taking care not to damage it, and ensure that the operating manual is always stored with the equipment and is easily accessible. Check the contents for completeness and verify that the equipment meets your application requirements.

### Scope of Supply

The scope of supply of the PowerView3 includes:

- PowerView3
- Cable for power supply (15 m / 49.2")
- Connector for power supply via an MIC ignition controller
- CAN cable (15 m / 49.2")
- Terminating resistor 120  $\Omega$
- 6 wire end ferrules
- 4 attachment clamps
- 4 attachment screws M3
- SDHC-card (8 GB)
- Storage device (USB flash drive or CD-ROM) with MOTORTECH Trend Viewer software for visualizing PowerView3 recordings
- Operating manual



## 6.2 Installation



### Use in potentially explosive atmospheres

For use in a hazardous area of Class I, Division 2, Groups C and D, T<sub>4</sub> in the USA and Canada, it is imperative that you observe the information of the CSA Certificate 2173514 (see section *Certifications* on page 15) for the PowerView3.

The PowerView3 is designed for installation in a control cabinet door. Install the device as follows:



### Installation by two people

MOTORTECH recommends that the PowerView3 is installed by two people.

1. Select a suitable place for the PowerView3. When selecting observe the following points:
  - The display must be easily visible and accessible for the user.
  - The interfaces of the device must not be covered by other components and wires (even when the door of the control cabinet is closed).
  - When the door of the control cabinet is closed, a minimum distance of 50 mm (2") to other components and cables must be maintained.
  - The device front has larger dimensions than the cut-out dimensions (see *Overview Drawings* on page 26).

## 6 Installation Instructions

2. Cut a rectangular opening with the following dimensions into the control cabinet door:

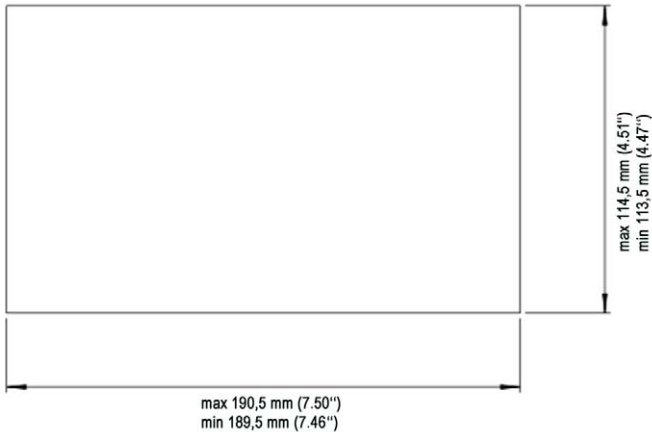

3. If necessary, remove sharp edges.
4. Carefully insert the PowerView3 into the opening from the outside.
5. Hold the PowerView3 firmly while a second person hooks in the four attachment clamps in the openings provided for this on the sides of the device.

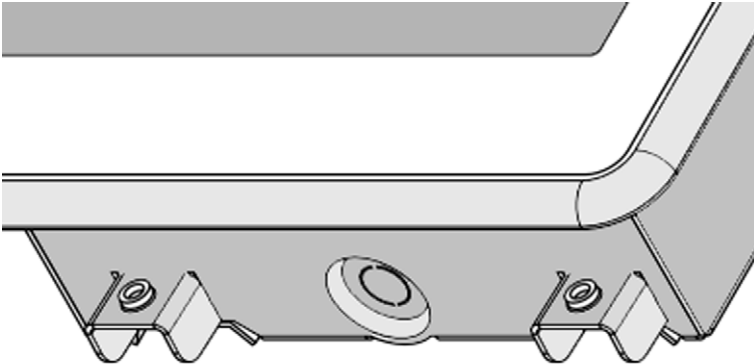

6. Carefully screw in the four fixing screws from the back while the second person firmly holds the PowerView3.
7. Check if the PowerView3 is mounted tightly in the correct position.
  - ▶ You can now wire the device (refer to section *Wiring of the Device* on page 35).

## 7 Wiring of the Device



### Use in potentially explosive atmospheres

For use in a hazardous area of Class I, Division 2, Groups C and D, T<sub>4</sub> in the USA and Canada, it is imperative that you observe the information of the CSA Certificate 2173514 (see section *Certifications* on page 15) for the PowerView3.

The PowerView3 must be securely mounted in a control cabinet before wiring (see section *Installation* on page 33).

### 7.1 CAN Bus Wiring

All devices are connected to the PowerView3 via a CAN bus. The communication via the bus is effected using the CANopen® protocol with a bit rate of 250 kbit/s.

#### General Information on CAN Bus Wiring

The wiring of the CAN bus requires three conductors (CAN Hi, CAN Lo and CAN Com). The conductors for CAN Hi and CAN Lo must be twisted wires. At a bit rate of 250 kbit/s, the bus may only have a maximum wire length of 250 m (820') and must be terminated at both ends by a terminating resistor of 120 Ω between the CAN Hi and CAN Lo conductors to prevent reflections.

## 7 Wiring of the Device

The diagram shows an example of the wiring for four devices:

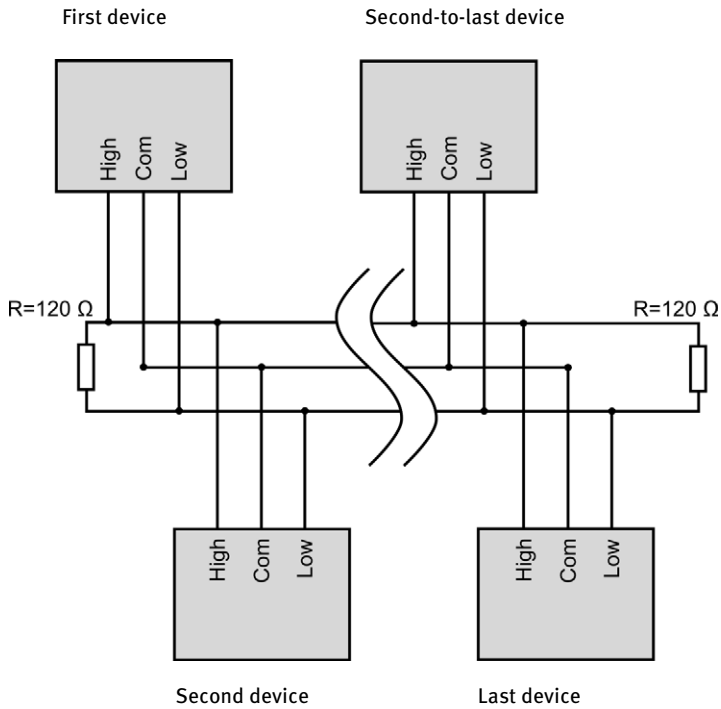



### CAN bus wiring

Note the following when connecting the CAN bus:

- Each bus end must be fitted with a terminating resistor of 120  $\Omega$  (see drawing).
- The maximum wire length depends on the bit rate:

Bit rate	Maximum wire length	Maximum length of a stub	Maximum length of all stubs
1 Mbit/s	25 m (82')	1.5 m (5')	7.5 m (25')
800 kbit/s	50 m (164')	2.5 m (8')	12.5 m (41')
500 kbit/s	100 m (328')	5.5 m (18')	27.5 m (90')
250 kbit/s	250 m (820')	11 m (36')	55 m (180')
125 kbit/s	500 m (1,640')	22 m (72')	110 m (360')
50 kbit/s	1,000 m (3,280')	55 m (180')	275 m (902')

- Only use cables that are specified by the manufacturer for use in the CAN bus.

The PowerView3 is delivered with a bit rate set to 250 kbit/s.

## 7 Wiring of the Device

### Pin Assignment of the Interface of the CAN Field Bus

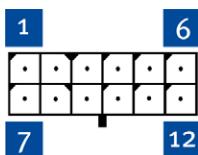

Pin	Assignment	Description
1	Com	Common ground for CAN and RS485 group
2	Term	Bridge with Hi for CAN bus termination
3	Hi	CAN Hi
4	Lo	CAN Lo
5	Term	Bridge with Lo for CAN bus termination

Pins 6 to 12 are reserved for the RS485 interface and are without function.



#### CAN bus termination

The PowerView3 has a built-in 120  $\Omega$  terminating resistor and must therefore be the last device in the CAN bus.

If the PowerView3 is not the last device in the CAN bus, the cables of connection 2 and 5 must be separated.

The arrangement of the interfaces of the PowerView3 can be found in the chapter *Interfaces* on page 24.

#### Connection of the CAN Cable

If needed, use the supplied wire end ferrules to connect the strands to clamps. The conductors of the CAN cable included are assigned as follows:

Color	Assignment
Green	Ground for CAN (Com)
White	CAN Hi
Brown	CAN Lo
Yellow	Not assigned

## 7 Wiring of the Device

The connector for the shielding must be connected with one of the four shielding connections at the back of the PowerView3.

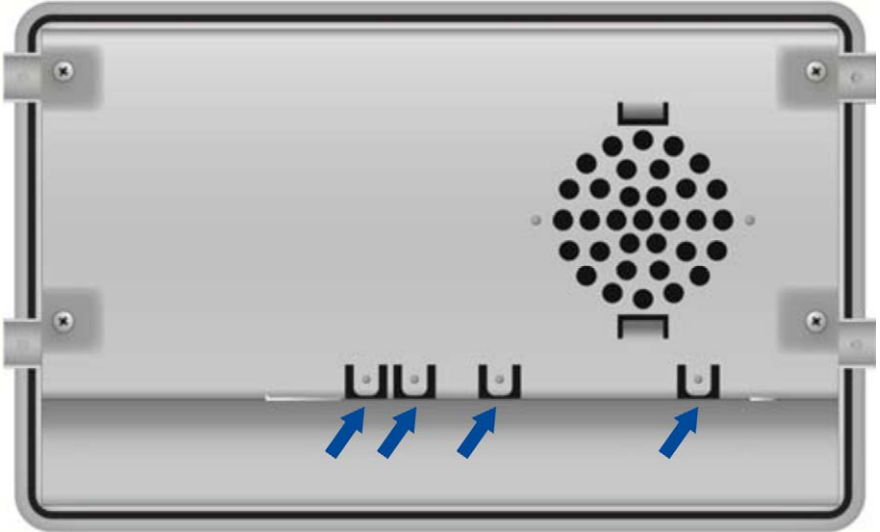

The other end of the conductor for the shielding must be suitably fitted.

## 7 Wiring of the Device

### Connection between Ignition Controller and PowerView3

As shown in the following illustrations, you can connect the PowerView3 directly to the MOTORTECH ignition controller (MIC3, MIC3+, MIC4, MIC4+, MIC5, MIC5+) using the CAN cable delivered with the PowerView3. To do so, you need to insert the connector into the CAN interface on the PowerView3. On the ignition controller, connect the color-coded conductors of the CAN cable to the correct CAN interface connections.

- With ignition controllers with a service cover, connect the CAN cable of the PowerView3 via the contacts of the corresponding connector strip.
- With ignition controllers without a service cover, connect the CAN cable of the PowerView3 via the contacts of the corresponding military style connector.

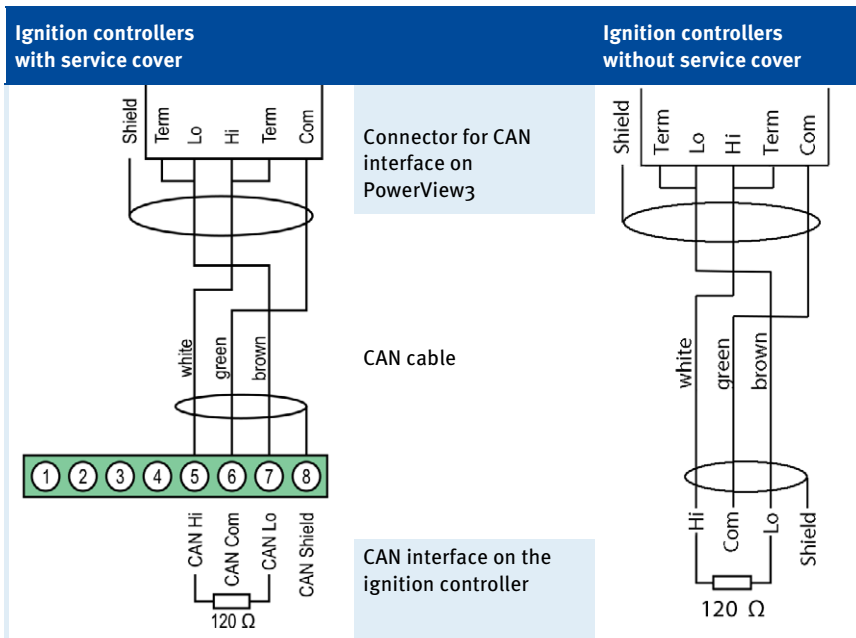

### Settings on the Devices

All connected devices are designated as nodes on the CAN bus. Each node is identified by a CANopen®-node ID. These node numbers must be indicated both in the connected devices as well as in the configuration of the PowerView3. Refer to the operating manuals of the respective devices for instructions on how to set the node ID for each device and to determine if further settings must be made to communicate via the CAN bus.

A node ID can only be assigned once within a CAN bus and must be a number between 1 and 127. Note that some devices use several node numbers. The node numbers must be assigned in the configuration after start-up of the PowerView3.





### Overview of the CAN bus

Setting up the CAN field bus requires the following settings:

- Activate CAN interface on the devices if applicable.
- Assign unique CANopen®-node IDs to the devices.
- Set bit rate of all devices to 250 kbit/s.



### CANopen® protocol

If you require information on the CANopen® protocol, contact your MOTORTECH contact person.

# 7 Wiring of the Device

## 7.2 Binary Inputs/Outputs



### Operational safety!

The PowerView3 and the software are not designed for safety-critical applications. The binary inputs and outputs of the PowerView3 must not be used for safety-critical purposes.

If warnings and errors occur in the detonation controller or in a temperature module, two binary outputs can be switched at the PowerView3. Binary output 1 is used for signalling warnings, binary output 2 for signalling errors. The binary inputs and outputs are galvanically isolated. The binary outputs can be activated in the PowerView3 in the *Device Setup* view. For this, refer to the section *Devices* on page 51. The binary inputs of the PowerView3 are without function.

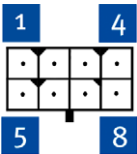

Pin	Assignment	Description	Level
1	GPI1	Input 1 (no function)	Low: 0 V, High: 3 V to 36 V 8.3 mA at 24 V typical
2	GPI2	Input 2 (no function)	Low: 0 V, High: 3 V to 36 V 8.3 mA at 24 V typical
3	Binary Com	Ground for binary IO group	
4	GND	Device ground	Negative potential of the device operating voltage (L-)
5	GPO1	Output 1 – Warning	Low: 0 V, High: corresponds to 7 Max. 800 mA at 24 V
6	GPO2	Output 2 – Error	Low: 0 V, High: corresponds to 7 Max. 800 mA at 24 V
7	Binary Power in	Supply input for binary IO group	< 36 V
8	Binary Power out	Supply output for binary IO group	Positive potential of the device operating voltage (L+)

# 7 Wiring of the Device



## 7.3 Power Supply



### Use in potentially explosive atmospheres

For use in a hazardous area of Class I, Division 2, Groups C and D, T4 in the USA and Canada, it is imperative that you observe the information of the CSA Certificate 2173514 (see section *Certifications* on page 15) for the PowerView3.

Before connecting the power supply, make sure that the CAN bus wiring is set up. Information on this is found in the section *CAN Bus Wiring* on page 35.

You have the following options to supply the PowerView3 with power.

### Power Supply via the PowerView3 Power Supply Connection

Connect the PowerView3 with the supplied cable for power supply via the corresponding connection at the PowerView3 to the power supply. The position of the connection for the power supply is found in the section *Interfaces* on page 24.

The power supply connection at the PowerView3 is assigned as follows:



Pin	Assignment
1	L-
2	L+ (9 V DC to 30 V DC, nominal voltage 24 V DC)

The L- connector is internally connected to the PowerView3 housing.

The conductors of the cable included for the power supply are assigned as follows:

Color	Assignment
White	L-
Brown	L+ (9 V DC to 30 V DC, nominal voltage 24 V DC)

If needed, use the supplied wire end ferrules for connecting the strands to clamps.

## 7 Wiring of the Device

### PowerView3 Power Supply via the Ignition Controller

If you use a MOTORTECH ignition controller with a service cover and connector strip, you have the option of supplying power to the PowerView3 via the ignition controller. A special connector is included in the PowerView3's scope of supply. The connector for the voltage supply of the ignition controller must be replaced by this one.

Connector supplied with the ignition controller:

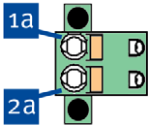

Connector supplied with PowerView3:

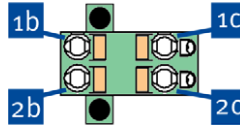

Proceed as follows:

1. Disconnect the power supply to the ignition controller and, if necessary, to the PowerView3.
2. Remove the connector for the power supply from the ignition controller.
3. **Negative terminal:** Disconnect the conductor from the contact **1a** and insert it into contact **1b** of the connector provided with the PowerView3.
4. **Positive terminal:** Disconnect the conductor from the contact **2a** and insert it into contact **2b** of the connector provided with the PowerView3.
5. From the PowerView3 power supply cable, plug the L- wire (white) into contact **1c**. For plugging into the contact, use a wire end ferrule provided with the PowerView3.
6. From the PowerView3 power supply cable, plug the L+ wire (brown) into contact **2c**. For plugging into the contact, use a wire end ferrule provided with the PowerView3.
7. Insert the connector provided with the PowerView3 into the power supply connection of the ignition controller.
8. Insert the connector at the other end of the PowerView3 power supply cable into the PowerView3 power supply connection.
9. Connect the device's power supply.
  - ▶ The power supply of the PowerView3 is now provided through the connector on the ignition controller.



### Switching on the PowerView3

When the power supply of the PowerView3 is connected, the device switches on automatically. If the power supply is interrupted, the device switches off.

General functions and setting options for the PowerView3 are described in this chapter. You can find information on the device menus of added devices in chapter *Devices* on page 74.



### Notice

In this manual, the screenshots and buttons are displayed in day mode. You can find out how to toggle between day and night mode in the section *Start Menu* on page 49.

### 8.1 Switching on and off the Device

The device is switched on by connection to the power supply and switched off by interrupting the power supply.

## 8 General Operation

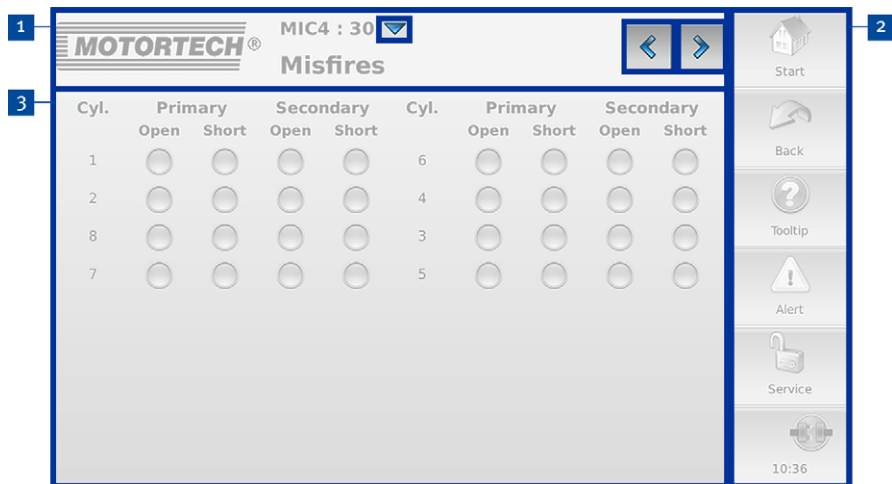

### 8.2 Navigation

The PowerView3 has a touchscreen, which can be operated directly with the finger or a special stylus pen (not included in scope of supply). The screen comprises the following areas:



#### 1 Title Area

The name of the current view is displayed in the title area of the PowerView3. If you are in a device menu, the device type and its node ID set in the PowerView3 are displayed. In each view, you can view detailed information on the PowerView3 by tapping on the MOTORTECH logo.

In certain views you can access additional options via the button  or open additional views via the buttons  and .

#### 2 Menu Bar





The menu bar on the right-hand side of the screen is always displayed. There is more information in the section *Menu Bar* on page 47.

#### 3 Main Window







In the main window, the PowerView3 is configured and the device menus of added devices are shown.

### 8.3 Menu Bar

The menu bar is always displayed and offers the following options and information:

Symbol	Function
 Start	With the <i>Start</i> button you reach the <i>Start Menu</i> . There is more information in the section <i>Start Menu</i> on page 49.
 Back	With the <i>Back</i> button you reach the next higher operating level of the PowerView3.
 Tooltip	<p>Information on the buttons and functions can be displayed in pop-up windows. Proceed as follows:</p> <ol style="list-style-type: none"><li>In the menu bar, tap the <i>Tooltip</i> button.<ul style="list-style-type: none"><li>The <i>Tooltip</i> button is now activated and framed light blue.</li></ul></li><li>Tap a button or an area of the display.<ul style="list-style-type: none"><li>A pop-up window with information opens.</li><li>The <i>Tooltip</i> button is deactivated.</li></ul></li><li>Tap the screen at any location to close the pop-up window.</li></ol> <p>To get information about other buttons and areas, the <i>Tooltip</i> button must be reactivated.</p>
 Alert	<p>The <i>Alert</i> button in the menu bar can display two states:</p> <ul style="list-style-type: none"><li>If the button is grayed, there are no messages.</li><li>The button is activated when messages are present.</li></ul> <p>To acknowledge messages, tap the activated button.</p> <ul style="list-style-type: none"><li>The <i>Event Log</i> view opens. The filter is automatically set so that only messages of devices that have reported alarms, warnings and errors are displayed.</li><li>In the <i>Start Menu</i>, devices which had a yellow frame now get a green frame again.</li><li>The button <i>Alert</i> is grayed again when you leave the view.</li></ul>

## 8 General Operation

Symbol	Function
	<p>This button informs about the status of the access control:</p> <ul style="list-style-type: none"><li>– <i>Operator, Service, Master</i>: The corresponding access level is set.</li><li>– <i>Locked</i>: The <i>Read Only</i> access level is set.</li><li>– <i>Disabled</i>: The access control is disabled.</li></ul> <p>By tapping this button, you can access the <i>Access Control</i> view. There is more information in the section <i>Access Control</i> on page 65.</p>
	<p>Status information of added devices is shown in the lower field of the menu bar.</p> <p>The database symbol provides information on the following states:</p> <ul style="list-style-type: none"><li> Trend data of added devices are recorded on the SD card inserted in the PowerView3.</li><li> An error has occurred while recording the trend data (e. g. insufficient memory space on SD card, SD card not readable).</li></ul> <p>The communication status symbol provides information on the following states:</p> <ul style="list-style-type: none"><li> There is a connection to all added devices.</li><li> The connection is not established to all added devices.</li><li> No device is connected.</li></ul> <p>The system time is displayed at the very bottom.</p> <p>If you tap the button for the connection status, the <i>Event Log</i> view opens. There is more information in the section <i>Event Log</i> on page 72.</p>



### 8.4 Start Menu

The *Start Menu* will be displayed after the PowerView3 has started. You can access the *Start Menu* any time via the *Start* button in the menu bar.



You have the following options in the *Start Menu*:

#### Devices

With this button you open the *Device Setup* view, in which you can add new devices and edit device settings. There is more information in the section *Devices* on page 51.

#### Display

With this button, you open the *Display Configuration* view. Among other things, you can set the language and system time of the PowerView3 and calibrate the display. There is more information in the section *Display* on page 57.

#### Connection

With this button, you open the *Communication Setup* view. You can change the node ID of the PowerView3 and the bit rate of all devices integrated in the CAN bus. There is more information in the section *Connection* on page 60.

## 8 General Operation

### Night Mode/Day Mode

With this button, you can change the display colors to ensure legibility under various lighting conditions.

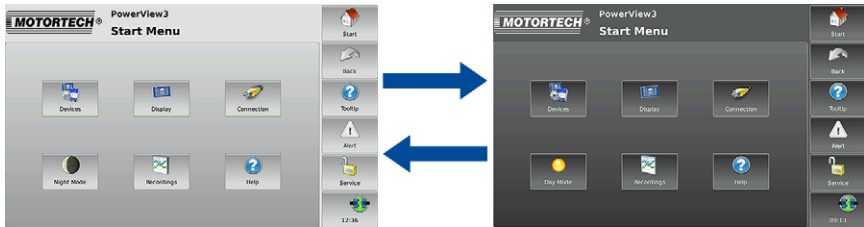

### Recordings

With this button, you open the *Recorded Files* view. You can display and administer recorded trend data from the inserted SD card. There is more information in the section *Recordings* on page 62.

### Help

This button opens the operating manual of the PowerView3. There is more information in the section *Help* on page 73.

### Added Devices

The buttons of added devices each display a device symbol, a device name and the node ID of the device configured in the PowerView3. The frames of the buttons can take different colors.



## 8 General Operation



The frames of the device buttons have the following meaning:

- Green: There are no errors.
- Red: The device is not connected. Check the connection and connection settings.
- Yellow: There are one or more messages for the device. Acknowledge the messages via the *Alert* button (see section *Menu Bar* on page 47).
- Purple: No valid activation code is available for this device (see section *Device Type Activation* on page 52).

Tapping on a device opens the *Main Menu* of the particular device. For information on how to configure devices, see section *Devices* on page 51.

### 8.4.1 Devices

The *Devices* button in the *Start Menu* opens the *Device Setup* view.



The *Device Setup* view provides the following options:

- **Remote Device**  
In this field, all added devices are listed. If you tap a device, class, node ID, and logging status are displayed below.
- **Edit**  
With the button you open the *Edit Device* dialog. You can find more information in the section *Editing a Device* on page 55.

## 8 General Operation

### – Logging

With the button you can record data of the selected device to an SD card inserted in the PowerView3. There is more information in the section *Logging Device Data* on page 55.

### – Add

With the button you open the dialog *Add Device*. You can find more information in the section *Adding a Device* on page 53.

### – Delete

Tap this button to delete an added device. You can find more information in the section *Deleting a Device* on page 55.

### – Device Type Activation

MOTORTECH provides you with the activation codes which are required to visualize devices in the PowerView3. There is more information in the section *Device Type Activation* on page 52.

With the *Back up* button, you can save activation codes with a USB flash drive or an SD card (e. g. before software updates).

### – Binary Outputs

In this area you can activate and deactivate the binary outputs of the PowerView3. The *Test* button opens a window in which you can switch the binary outputs. This allows you to test the behavior of devices that are connected to the binary outputs. For added devices, you can set warning and error signalling via binary outputs in the following views:

- DetCon detonation controller: *Preferences* view (see *Preferences* on page 108)
- TempScan temperature module: *Settings Channel x* view (see *Channels* on page 117)



#### **Operational safety!**

The PowerView3 and the software are not designed for safety-critical applications. The binary inputs and outputs of the PowerView3 must not be used for safety-critical purposes.



#### **Operational safety!**

Testing the binary outputs affects the connected devices. Before performing tests, make sure that switching the binary outputs will not result in hazards or damage.

### 8.4.1.1 Device Type Activation

In order to visualize and operate a device in the PowerView3, the corresponding device type must be activated. At least one device type is already activated as a factory setting.

Activate a new device type as follows:

1. Insert an external storage medium with an activation code from MOTORTECH into your PowerView3.
2. In the *Device Setup* view, tap *Activate*.
  - ▶ The storage locations available are displayed in a window.
3. Navigate to the desired activation code with the file extension *.ssk* and select it.
4. Tap *Enter*.
  - ▶ The device type is activated.
  - ▶ You can visualize and operate devices of the activated type in the PowerView3.



### 8.4.1.2 Adding a Device



#### Maximum number of added devices

In the PowerView3, you can add one ignition controller (MIC3, MIC3+, MIC4, MIC4+, MIC5, MIC5+), one DetCon detonation controller, three TempScan temperature modules and three devices of the type *Generic*.

To add a device, proceed as follows:

1. In the *Device Setup* view, tap the *Add* button.
  - ▶ The dialog *Add Device* opens.
    -  This symbol next to a device type indicates that this device type is activated.
    -  This symbol next to a device type indicates that this device type is not activated (see section *Device Type Activation* on page 52). A device of this type can be added but you cannot visualize device data or operate it.
2. Select the device type. For more information on the device type *Generic*, read the section *Device Type Generic* on page 56.
3. Set the node ID of the device that should be added with the arrow keys.



#### Node ID

The node ID entered must correspond to the node ID of the device to be added. To learn about the node ID, refer to the operating manual of the respective device.

## 8 General Operation

- Confirm your entry via the *Save* button.
  - The dialog is closed and you are returned to the *Device Setup* view. Here the added device with device class and node ID is displayed as *Remote Device*.

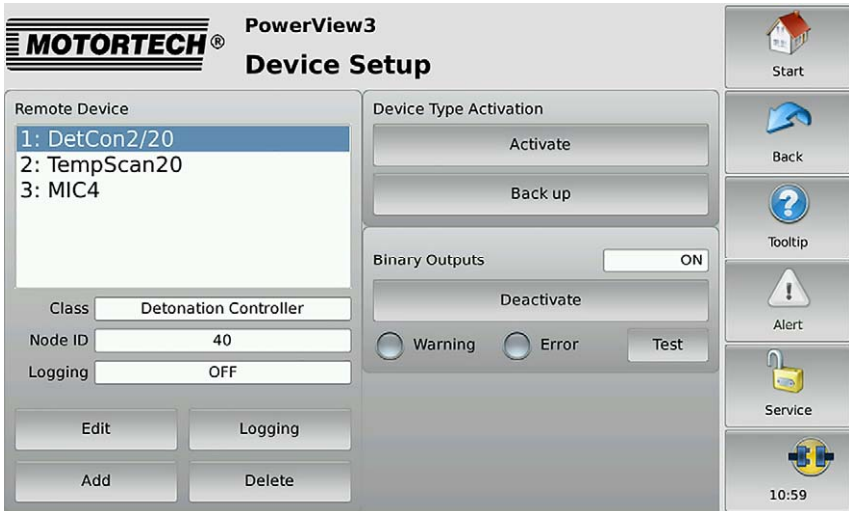

- If you tap *Start* in the menu bar, the device and its node ID will be displayed in the *Start Menu*.



### 8.4.1.3 Editing a Device

In order to edit the settings for a device, proceed as follows:

1. In the *Device Setup* view, select the device whose settings you want to change under *Remote Device*.
2. Tap the *Edit* button.
  - ▶ The dialog for editing devices opens.
3. Enter the device type and node ID.
4. Tap *Save*.
  - ▶ The dialog is closed.
  - ▶ The device is displayed with changed settings in the *Device Setup* view and in the *Start Menu*.

### 8.4.1.4 Deleting a Device

To delete an added device, proceed as follows:

1. In the *Device Setup* view, select the device that you want to delete under *Remote Device*.
2. Tap *Delete*.
  - ▶ The device is no longer displayed in the *Device Setup* view and in the *Start Menu*.

### 8.4.1.5 Logging Device Data

The PowerView3 enables you to record trend data (e. g. speed, knocking intensity and temperature) of added devices on an SD card inserted in the PowerView3. You can then display and administer the recordings with the PowerView3 (see section *Recordings* on page 62) or the MOTORTECH Trend Viewer (see section *Recordings* on page 62). For each device, you can start and stop the recording of trend data in the *Device Setup* view.

#### Starting a Recording

1. Make sure that a suitable SD card is inserted into the memory card slot of your PowerView3 (see *Interfaces* on page 24).
2. In the *Device Setup* view, select the device whose data you would like to record in the area *Remote Device*. If the device has the recording status *OFF* under *Logging*, no data is recorded from the device.
3. Tap the *Logging* button.
  - ▶ The device's recording status in the *Remote Device* area changes to *ON*.
  - ▶ A database symbol  in the menu bar indicates that data is being recorded.
  - ▶ You can start or end more recordings and use other functions of the PowerView3 without an active recording ending.
  - ▶ The recording is not interrupted by the screen saver.

## 8 General Operation

### Ending a Recording

1. In the *Device Setup* view, select the device for which you would no longer like to record data in the area *Remote Device*. If the device has the recording status *ON* under *Logging*, data is recorded from the device.
2. Tap the *Logging* button.
  - ▶ The device's recording status in the *Remote Device* area changes to *OFF*.
  - ▶ The recording is ended. The database symbol  in the menu bar disappears if no further recordings are being made.
  - ▶ You can administer and display the recorded data (see section *Recordings* on page 62).



#### Recording data

If the power supply to the PowerView3 is interrupted during recording or the SD card is removed, data may be lost.

Each time you restart the PowerView3 and each time you insert an SD card, a new recording file is created in the selected folder.

### 8.4.1.6 Device Type Generic

You can add up to three devices that are not directly supported by the PowerView3 as *Generic* devices and monitor their communication status.



#### Generic devices are not displayed in the Start Menu

*Generic* devices appear in the *Device Setup* view in the *Remote Device* area. These devices are not displayed in the *Start Menu*.

### Functions

- When a device of the device type *Generic* is added in the device setup, it will be started, providing this has not already been done.
- The communication status is monitored by the PowerView3 and is visualized in the menu bar (see section *Menu Bar* on page 47).
- Changes to the communication status are listed in the *Event Log* view (see section *Event Log* on page 72).





## 8 General Operation



### 8.4.2 Display

The *Display* button in the *Start Menu* opens the following views:

- *Display Configuration*
- *Display Information*

The  and  buttons allow you to switch between the views.

The views are described as follows.

#### Display Configuration

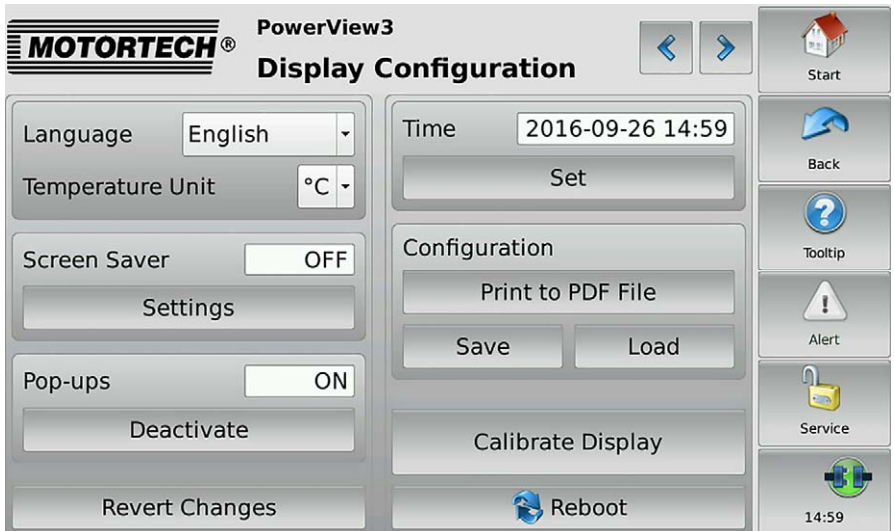

You have the following options:

- **Language**  
Select the desired system language.
- **Temperature Unit**  
Select, whether temperatures in the PowerView3 are to be displayed in °C or in °F. Recordings are also created in the units selected.
- **Screen Saver**  
When the screen saver has been activated, the display is switched off after a specified time (1 min to 99 min) or a slide show starts. Also, the PowerView3 is placed on the access level *Read Only* (displayed status *Locked* in the menu bar) or the minimum level set.

By touching the display, the running screen saver is stopped.

## 8 General Operation



### Setting up an individual screen saver

In the default configuration, the slide show contains pictures of MOTORTECH products. If you want the screen saver to display your own pictures, you can set this up as follows:

1. Create a folder named *motortech-slides* in the root directory of a USB flash drive or an SD card.
2. In this folder, store pictures in JPG format with the size of 800 x 480 pixels.
3. Name the pictures *1.jpg, 2.jpg ... x.jpg*; numbering must be continuous.
4. Insert the storage medium into your PowerView3.
  - ▶ When the slide show starts, your pictures are displayed.

### – Pop-ups

Activate or deactivate pop-ups with information for the user. Important pop-ups, e. g. with information on errors are always displayed. Pop-ups which e. g. provide information on successful actions can be deactivated.

### – Revert Changes

Tap *Revert Changes* to restore the status of the last stored configuration. Date and time are not affected.

### – Time

Tap *Set* to set the system time and the date.

### – Configuration

You have the following options:

#### – Print to PDF File

Save a PDF document with information on display configuration, connected devices, memory usage, and a list of events to a USB flash drive or an SD card.

#### – Save

Save the configuration data of your PowerView3 to a USB flash drive or an SD card in XML files. One file is created for the configuration of the PowerView3 and one file for each added TempScan temperature module. This enables you to easily restore the configuration of your device or transfer it to other devices.

#### – Load

Load a configuration that is stored on a USB flash drive or on an SD card. Open the configuration via the contextual menu.

### – Calibrate Display

Calibration of the display is required if the display does not register touches at the desired point. Tap as precisely as possible in the midpoint of the five successively displayed X's to do this. The calibration is then automatically ended after conclusion.

## 8 General Operation











### – Reboot

With the *Reboot* button, you carry out a reboot of your PowerView3. Settings that were not saved get lost and databases are closed.

### Display Information

In the *Display Information* view, you can find the following information:

- Display ID
- MOTORTECH serial number
- Arrangement number
- Board support package version
- Software version of your PowerView3

 <b>PowerView3</b>		 	 Start
Display ID	<input type="text" value="00080039"/>		 Back
MOTORTECH S/N	<input type="text" value="1223345"/>		 Tooltip
Arrangement No.	<input type="text" value="PV3.00.0000-000-AA-A"/>		 Alert
Board Support Package	<input type="text" value="1.41.0"/>		 Service
Software	<input type="text" value="1.6.0"/>		 14:59

## 8 General Operation

### 8.4.3 Connection

The *Connection* button in the *Start Menu* opens the *Communication Setup* view.

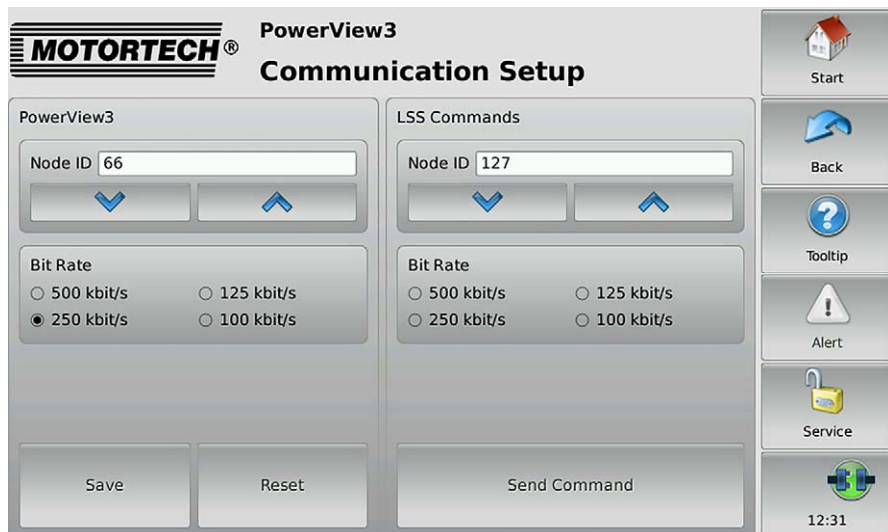

#### MOTORTECH devices preset to 250 kbit/s

For communication via the CAN bus, it is mandatory that all connected devices use the same bit rate. MOTORTECH devices are usually delivered with a bit rate set to 250 kbit/s. Use this bit rate in the PowerView3 as well.

The *Communication Setup* view provides the following options:

#### PowerView3

##### Changing Node ID

The factory setting for the node ID on your PowerView3 is 66. Change the node ID as follows:

1. You can set a node ID for your PowerView3 in the *PowerView3* area using the arrow keys.
2. Tap *Save* to confirm the setting of the node ID.
  - ▶ The node ID of the PowerView3 is changed.

The changed node ID will be discarded if you tap *Reset* before saving or leave the *Communication Setup* view without saving.

## 8 General Operation



### Changing Bit Rate

Change the bit rate of the PowerView<sub>3</sub> as follows:

1. Select the desired bit rate in the *PowerView<sub>3</sub>* area.
2. Tap *Save*.
  - ▶ The bit rate of the PowerView<sub>3</sub> is changed.

### Other Devices



#### **LSS commands: Disconnect all other devices from the CAN bus!**

When sending LSS commands, all devices connected to the CAN bus are addressed. In order to change the bit rate or the node ID of the desired device only, no other devices may be connected to the PowerView<sub>3</sub> via the CAN bus.



#### **LSS commands: Use identical bit rates!**

LSS commands can only be received from another device in the CAN bus if the LSS master (here: PowerView<sub>3</sub>) is set to the bit rate of the other device. If necessary, set the corresponding bit rate in the PowerView<sub>3</sub> before sending the LSS command.

### Changing Node ID

You can change the node ID of another device in the CAN bus as follows:

1. Make sure that the current bit rate of the other device is set in the PowerView<sub>3</sub>.
2. Make sure that there is only the other device connected to the PowerView<sub>3</sub> via the CAN bus.
3. Set the node ID that the other device is to be given in the *LSS Commands* area.
4. Tap *Send Command*.
  - ▶ The node ID of the other device is changed.
5. If you have changed the PowerView<sub>3</sub> bit rate in step 1, set the PowerView<sub>3</sub> back to the previous bit rate in the *PowerView<sub>3</sub>* area, if required.

### Changing Bit Rate

You can change the bit rate of another device in the CAN bus as follows:

1. Make sure that the current bit rate of the other device is set in the PowerView<sub>3</sub>.
2. Make sure that there is only the other device connected to the PowerView<sub>3</sub> via the CAN bus.

## 8 General Operation

3. Make sure that the current node ID of the other device is set in the *LSS Commands* area. Otherwise, it will be changed accordingly when the LSS command is sent.
4. Select the bit rate that the other device is to be given.
5. Tap *Send Command*.
  - ▶ The bit rate and the node ID of the other device are changed.
6. If you have changed the bit rate of the PowerView3 in step 1, set the PowerView3 back to the previous bit rate in the *PowerView3* area, if required.

### 8.4.4 Recordings

The PowerView3 enables you to record trend data of the added devices on an SD card inserted in the PowerView3. The *Recordings* button in the *Start Menu* opens the *Recorded Files* view, which allows you to display and administer recordings.

**MOTORTECH® Recorded Files**

Device: All Devices | Node ID: All Nodes | Date: All dates | Size: All sizes

Device	ID	Date	Time	Size	Logging
TempScan20	127	2015-10-19	13:30:07	0	x
DET2_20	40	2015-09-23	07:43:59	68	
DET2_20	40	2015-09-22	15:18:20	272	
TempScan20	127	2015-09-22	15:18:15	106	
DET2_20	40	2015-09-22	15:17:49	0	
DET2_20	40	2015-09-22	08:45:31	0	
TempScan20	127	2015-09-22	08:45:25	0	
TempScan20	127	2015-09-22	08:43:50	0	
TempScan20	127	2015-09-22	08:42:31	105	
TempScan20	127	2015-09-21	08:06:33	23.7K	
TempScan20	127	2015-09-17	14:13:20	5.31K	

Buttons: Delete, Delete All, Back up, Plot

Right Panel: Start, Back, Tooltip, Alert, Service, 14:57

At first all recorded files are displayed. You have the option of filtering the recordings according to device type, node ID, alteration date and file size. In the *Date* and *Size* drop-down lists, the double arrows indicate the sorting order.

You have the following options for navigating in the list:

- Double tap the upper or lower region of the list to jump to the top or bottom of the list.
- Tap the list and drag it to the desired entry.
- Tap and hold the upper or lower region of the list to scroll the list up or down.
- Move the scroll bar to scroll up and down.

## 8 General Operation



The view has the following buttons:

- **Delete**  
Deletes the currently selected file.
- **Delete All**  
Deletes all currently displayed files based on the filter settings.
- **Back up**  
With this button you can back up the currently selected file on an external storage device.
- **Plot**  
Displays the currently selected file in the PowerView<sub>3</sub> (see *Displaying Recordings* on page 63).

Files of running recordings are marked with an X in the *Logging* column. These files can neither be saved nor deleted.

### 8.4.4.1 Displaying Recordings

You have the option to display recorded data from the SD card inserted in the PowerView<sub>3</sub>:

1. Select the desired file in the *Recorded Files* view.
2. Tap the *Plot* button.
  - ▶ The selected file is opened.

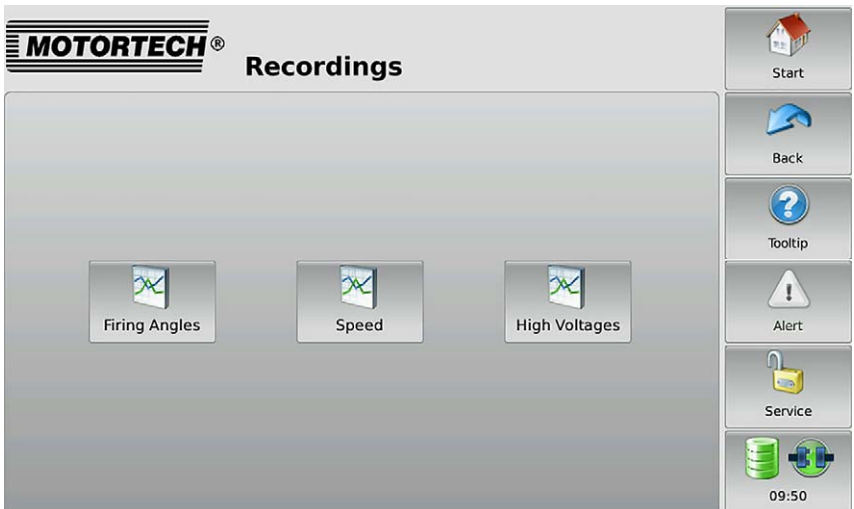

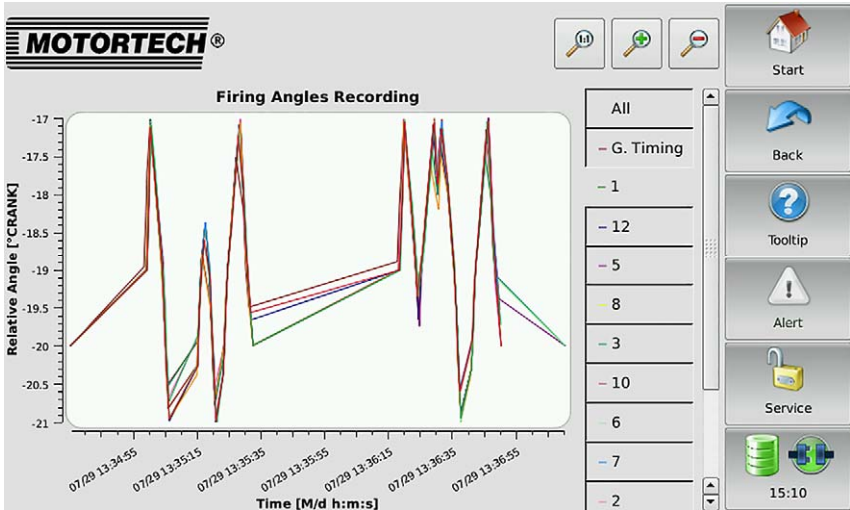

## 8 General Operation

3. Select a button in the view (for example *Firing Angles*) to display the recorded data.
  - ▶ The selected data is displayed.



You can customize the recording views to suit your requirements:

- Use the legend on the right of the graph to display and hide trend lines individually.
- Adjust the enlargement factor:
  -  Overall view
  -  Larger
  -  Smaller
- Move the trend lines by tapping and dragging them directly in the display.

### 8.4.4.2 Processing Data on the PC

With the MOTORTECH Trend Viewer software, you can process data on your PC that has been recorded with the PowerView3. The software provides the following options:

- Visualization of data
- Export of data as CSV file
- Export of data as graphic file

Further information can be found in the MOTORTECH Trend Viewer operating manual.



## 8.5 Access Control

The access control can be accessed in the menu bar via the highlighted button. Depending on the current setting, the button is labeled *Disabled*, *Locked*, *Operator*, *Service* or *Master*.

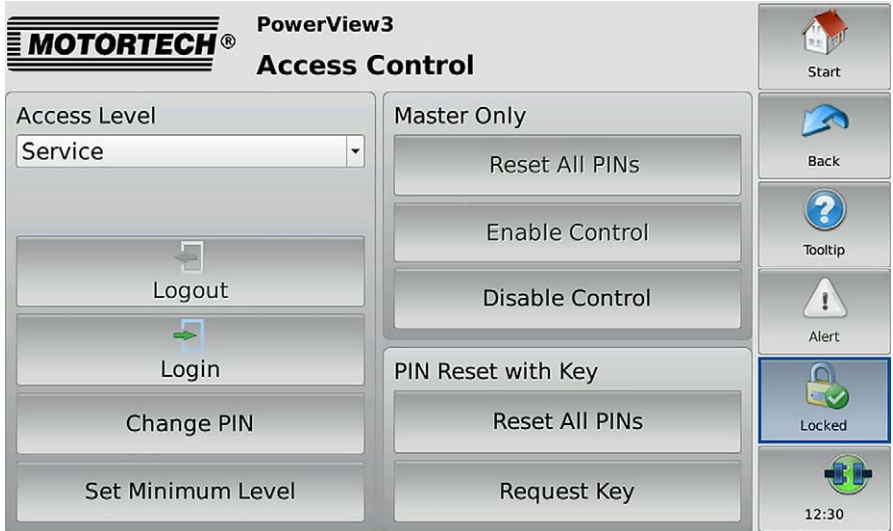

The access control of the PowerView3 serves to protect sensitive data and functions. If the access control is enabled (see section *Enabling/Disabling Access Control* on page 66), four access levels with different rights are available:

Access level	Rights
Read Only (displayed status in the menu bar: <i>Locked</i> )	<ul style="list-style-type: none"> <li>- Read access to all data provided</li> <li>- Switch between day and night mode</li> <li>- Activate and deactivate pop-ups</li> <li>- Screen calibration</li> <li>- Change DetCon settings</li> </ul>
Operator	<ul style="list-style-type: none"> <li>- Read Only rights</li> <li>- Complete display configuration</li> <li>- Record device data</li> <li>- MIC3, MIC3+, MIC4, MIC4+, MIC5, MIC5+:                             <ul style="list-style-type: none"> <li>- Acknowledge runtime errors</li> <li>- Acknowledge alarms</li> </ul> </li> <li>- Reset misfire rate</li> </ul>

## 8 General Operation

Access level	Rights
Service	<ul style="list-style-type: none"><li>– Operator rights</li><li>– Complete display configuration</li><li>– Change the node ID and the bit rate of the PowerView3</li><li>– Activate device types</li><li>– MIC3, MIC3+, MIC4, MIC4+, MIC5, MIC5+:<ul style="list-style-type: none"><li>– Energy Adjustments</li><li>– Ignition timing adjustment</li><li>– Self Test</li><li>– Set engine operating hours</li><li>– Set the spark plug operating hours</li></ul></li><li>– Change TempScanzo settings</li></ul>
Master	<ul style="list-style-type: none"><li>– Service rights</li><li>– Enable/Disable access control</li><li>– Reset all PINs</li><li>– Firmware update</li><li>– Transmit LSS commands</li></ul>



### Access to locked functions

If you would like to access a function with enabled access control, which exceeds your currently set rights, you will be prompted to enter the PIN for the access level required.

### 8.5.1 Enabling/Disabling Access Control



#### Access control in as-delivered state

In as-delivered state, the access control is not enabled and all PINs are set to 0000. After enabling the access control, assign an individual PIN for each access level including *Master* (see *Changing the PIN* on page 70).

## 8 General Operation



### Enabling Access Control

Enable the access control for all access levels as follows:

1. Tap the *Enable Control* button.
  - ▶ You are prompted to enter the PIN for the access level *Master*.
2. Enter the PIN for the access level *Master* and tap *Enter*.
  - ▶ Access control for all access levels is enabled.
  - ▶ You are logged in as *Master*.
  - ▶ The *Logout* button is activated.
  - ▶ The *Disable Control* button is activated.

If necessary, you can log on for a different access level. Refer to the section *Logging in and Logging out* on page 68.

### Disabling Access Control



#### Disabling access control

If the access control is not to be used for a longer period of time, we recommend that you write down the Master PIN or reset all PINs to 0000 before disabling the access control. A renewed enabling of the access control is only permitted with the Master PIN. If you have forgotten the Master PIN, you must contact MOTORTECH for a reset of all PINs (see *Resetting the PINs* on page 70).

Disable the access control for all access levels as follows:

1. Tap the *Disable Control* button.
  - ▶ You are prompted to enter the PIN for the access level *Master*.
2. Enter PIN for the access level *Master* and tap *Enter*.
  - ▶ The *Disabling Access Control* dialog window appears.
3. Observe the note in the *Disabling Access Control* dialog window. If you are certain that you want to the disable access control, answer the displayed question by tapping *Yes*.
  - ▶ Access control for all access levels is disabled.
  - ▶ If you have set a minimum level, it will be deleted.
  - ▶ In the menu bar the condition *Disabled* is displayed.
  - ▶ The buttons *Login* and *Logout* are deactivated.
  - ▶ The *Enable Control* button is activated.

## 8 General Operation

### 8.5.2 Minimum Level

If your PowerView3 with enabled access control is not to be set to the access level *Read Only* (displayed status *Locked*) after logging out, but instead to a higher access level, you can set a minimum level. The minimum level is defined as the access level that is set automatically after logging out with enabled access control. As a result, the functions of the minimum level are always available and do not have to be released again by PIN entry.



#### Minimum level functions are always available

Become acquainted with the rights of the individual access levels before you set the minimum level. The functions of the minimum level set are always available without PIN entry (see section *Access Control* on page 65).

#### Setting Minimum Level

With enabled access control, set the minimum level as follows:

1. In the *Access Level* entry, select the access level which is to be set as minimum level from the drop-down list.
  - ▶ *Read Only* cannot be set as minimum level.
  - ▶ If the selected minimum level is higher than the currently set access level, you will be prompted to enter the corresponding PIN.
2. Tap *Set Minimum Level*.
  - ▶ The access level set is set as minimum level.

#### Deleting Minimum Level

With enabled access control, you have two options for deleting the minimum level:

- In the *Access Level* entry, set a different access level as minimum level from the drop-down list.
- Tap *Delete Minimum Level*. This sets the access level *Read Only* when logging out.

When disabling the access control, the minimum level is automatically deleted.

### 8.5.3 Logging in and Logging out

With enabled access control, you can log on for the access levels *Operator*, *Service* and *Master*.

#### Logging in

Log in as follows for the desired access level:

1. From the drop-down list under *Access Level*, select the desired access level (*Operator*, *Service* or *Master*).

2. Tap the *Login* button.
  - ▶ You will be prompted to enter the corresponding PIN.
3. Enter the PIN and confirm your entry.
  - ▶ You have now logged onto the desired access level and can use the associated functions.
  - ▶ The access level set is displayed in the menu bar.

### Logging out



#### Automatic logging out

You are automatically logged out of the access levels *Operator*, *Service* or *Master*,

- if you have not entered anything for six minutes.
- if for six minutes only functions of lower access levels are used.
- if the screen saver is switched on.

The PowerView3 is then placed on the access level *Read Only* with the displayed status *Locked* or the minimum level set.

There are three options for logging out manually from the access levels *Operator*, *Service* or *Master*:

#### Option 1:

Leave the currently set access level with the *Logout* button in the *Access Control* view.

- ▶ In the menu bar, the status *Locked* or the currently set minimum level is displayed.
- ▶ The access level set is *Read Only* or the currently set minimum level.
- ▶ The *Logout* button is deactivated.
- ▶ The *Login* button is activated.

#### Option 2:

1. From the drop-down list under *Access Level* in the *Access Control* view, select a different access level (*Operator*, *Service* or *Master*).
2. Tap the *Login* button.
  - ▶ You will be prompted to enter the corresponding PIN.

## 8 General Operation

3. Enter the PIN and confirm your entry.
  - ▶ You have now logged onto the desired access level and can use the associated functions.
  - ▶ The access level set is displayed in the menu bar.

Option 3 (also available if you are not in the *Access Control* view):

1. Tap the symbol for access control in the menu bar.
  - ▶ A window opens in which you can choose between *Logout* and *Open Access Control*.
2. Select *Logout*.
  - ▶ In the menu bar, the status *Locked* or the currently set minimum level is displayed.
  - ▶ The access level set is *Read Only* or the currently set minimum level.

### 8.5.4 Changing the PIN

Change the PIN of the access levels *Operator*, *Service* or *Master* as follows:

1. Log on for the access level (*Operator*, *Service* or *Master*) whose PIN you want to change (see section *Logging in and Logging out* on page 68).
2. Tap the *Change PIN* button.
  - ▶ You are prompted to enter the current PIN for the active access level.
3. Enter the current PIN.
  - ▶ You are prompted to enter a new PIN for the active access level.
4. Enter the new four-digit PIN.
5. Tap the input field next to *Confirm New PIN*.
6. Enter the new PIN a second time.
7. Tap the *Enter* button to save your new PIN.
  - ▶ The PIN of the active access level was changed.

### 8.5.5 Resetting the PINs

#### Forgotten Operator PIN / Service PIN

If you have forgotten the PIN for the access levels *Operator* or *Service*, contact the Master. The latter can reset all PINs to the value *0000* as described in the following. Afterwards, new PINs must be assigned for all access levels.

### Resetting All PINs

The authorization for the access level *Master* allows you to reset the PINs of all access levels:

1. Log in for the access level *Master* (see section *Logging in and Logging out* on page 68).
2. In the area *PIN Reset with Key*, tap on *Reset All PINs*.
  - ▶ All PINs are reset to the value *0000*.



#### Assign new PINs!

After resetting the PINs, new PINs must be assigned for all access levels to guarantee maximum security.

### Master PIN Forgotten

If you have forgotten the Master PIN, you must apply for a PIN Reset Authorization Key from MOTORTECH. With this key you can reset all PINs without authorization for the access level *Master*.

### Requesting Key

Request the key from MOTORTECH as follows:

1. Tap the *Request Key* button.
  - ▶ A dialog window with the new and actual PIN Reset Request Key opens.
  - ▶ Send the new PIN Reset Request Key (*New PRRK*) to your MOTORTECH contact person.
2. Tap the *Confirm Request* button.
  - ▶ MOTORTECH sends you a PIN Reset Authorization Key based on *New PRRK*. Note that the PIN Reset Authorization Key is only valid for a limited period of time.

### Entering Key

Enter the key from MOTORTECH in your PowerView3 as follows:

1. Insert the external storage medium containing the MOTORTECH key into your PowerView3.
2. In the area *PIN Reset with Key*, tap the button *Reset All PINs*.
  - ▶ The storage locations available are displayed in a window.
3. Navigate to the desired PIN Reset Authorization Key (file extension *.prak*) and select it.
4. Tap the *Enter* button.
  - ▶ All PINs are reset to the value *0000*.

## 8 General Operation

### 8.6 Event Log

If you tap on the status information field in the menu bar (see marking), the *Event Log* view opens. In this view you get messages concerning the PowerView3.

Date	Time	ID	Device	Message
2016-09-26	14:57:47	80	TempScan20	Device connection failed
2016-09-26	14:24:16	67	PowerView	Access level set to Service.
2016-09-26	12:44:56	67	PowerView	Access level set to Nur Lesen.
2016-09-26	12:38:55	67	PowerView	Access level set to Service.
2016-09-26	12:38:43	32	MIC5	Device connection failed
2016-09-26	12:38:42	1	DetCon16	Device connection failed
2016-09-26	12:38:42	127	TempScan20	Device connection failed
2016-09-26	12:38:03	67	PowerView	Access control enabled.
2016-09-26	12:38:03	67	PowerView	Started Revision 28830M of PowerView3
2016-09-22	13:37:40	67	PowerView	1 -  Access level set to Bediener.
2016-09-22	13:38:02	67	PowerView	Access level set to Service.
2016-09-22	13:37:34	67	PowerView	Access level set to Nur Lesen.
2016-09-22	13:37:27	67	PowerView	Access level set to Bediener.
2016-09-22	12:49:28	32	MIC5	Device connection failed
2016-09-22	12:49:28	1	DetCon16	Device connection failed
2016-09-22	12:49:28	127	TempScan20	Device connection failed
2016-09-22	12:49:02	67	PowerView	Access level set to Nur Lesen.
2016-09-22	12:48:57	67	PowerView	Access level set to Bediener.

The following data is displayed: date (YYYY-MM-DD) and time (HH:MM:SS) of the entry, node ID of the device, device name and the accompanying message. In the title area, two buttons are displayed. The symbols on the buttons change depending on their setting and are described in the following.

#### Filter Button

The button's appearance has the following meaning:



No filters are active. All entries are displayed.



Filters are active. Only certain entries are displayed.

To set or change filters, tap the *Filter* button. The *Filter Settings* dialog window appears. Select time and node IDs of the entries you want to display. If you select none of the listed node IDs, the entries for all listed node IDs are displayed. Confirm your selection with *OK*. Tap *Clear* to reset the filters.

#### Automatic Scrolling Button

The button's appearance has the following meaning:



Automatic scrolling is inactive.



Automatic scrolling is active.



To activate and deactivate automatic scrolling, tap the *Automatic Scrolling* button. When the function is activated, the PowerView3 scrolls automatically to newly registered entries.

You have the following options for navigating in the list:

- Double tap the upper or lower region of the list to jump to the top or bottom of the list.
- Tap the list and drag it to the desired entry.
- Tap and hold the upper or lower region of the list to scroll the list up or down.
- Move the scroll bar to scroll up and down.

### 8.7 Help

You can access the operating manual of the PowerView3 or an added device as follows:

- *Help* button in *Start Menu*: operating manual of the PowerView3
- *Help* button in *Main Menu* of an added device: operating manual of the added device

In the browser, tap on the appropriate links, and then use the bars on the right side of the screen to scroll and the buttons for navigation:

- **Start**  
Use this button to go to the first page of the operating manual.
- **Back**  
Use this button to go to the previously displayed page of the operating manual.
- **Close**  
Use this button to exit the Help menu.

## 9 Devices

This chapter describes the device menus of the devices that can be added in the PowerView3. Information about adding devices can be found in the section *Devices* on page 51.

You can access the device menus of added devices via the corresponding buttons in the *Start Menu*.

### 9.1 MIC Ignition Controller

This section describes the functions of the device menu for an added MIC ignition controller.

#### 9.1.1 Main Menu

The main menu of an added MIC ignition controller can be opened in the *Start Menu* via the button *MIC3*, *MIC3+*, *MIC4*, *MIC4+*, *MIC5* or *MIC5+*.



The main menu has the following buttons:

- **Overview**  
With the button you obtain information on the most important operating data. There is more information in the section *Overview* on page 76.
- **Timing**  
With the button you receive information on ignition timing. There is more information in the section *Timing* on page 78.
- **Ignition**  
With the button you receive information on secondary voltages and misfires. There is more information in the section *Ignition* on page 79.

- **Energy**  
With the button you receive information on energy output and spark duration. There is more information in the section *Energy* on page 82.
- **Firing Angles**  
With the button you receive information on the absolute and relative firing angles. There is more information in the section *Firing Angles* on page 82.
- **Adjustments**  
With the button you can access further views in which you can make runtime adjustments for the ignition controller. In addition, you can carry out a self test. There is more information in the section *Adjustments* on page 85.
- **Trends**  
With the button you gain access to the ignition angles and secondary voltages trend. There is more information in the section *Trends* on page 93.
- **Message Log**  
In this view, information, alarms, warnings and errors are listed. There is more information in the section *Message Log* on page 96.
- **Diagnosis**  
With the button you receive information on the operating data of the ignition controller. There is more information in the *Diagnosis* on page 98 view.
- **Information**  
With the button you receive data on the hardware and software of the remote ignition controller. There is more information in the section *Information* on page 99.
- **Help**  
This button opens the operating manual of the ignition controller. There is more information in the section *Help* on page 73.

## 9 Devices

### 9.1.2 Overview

The *Overview* button in the *Main Menu* of the added MIC ignition controller opens the *Overview*.

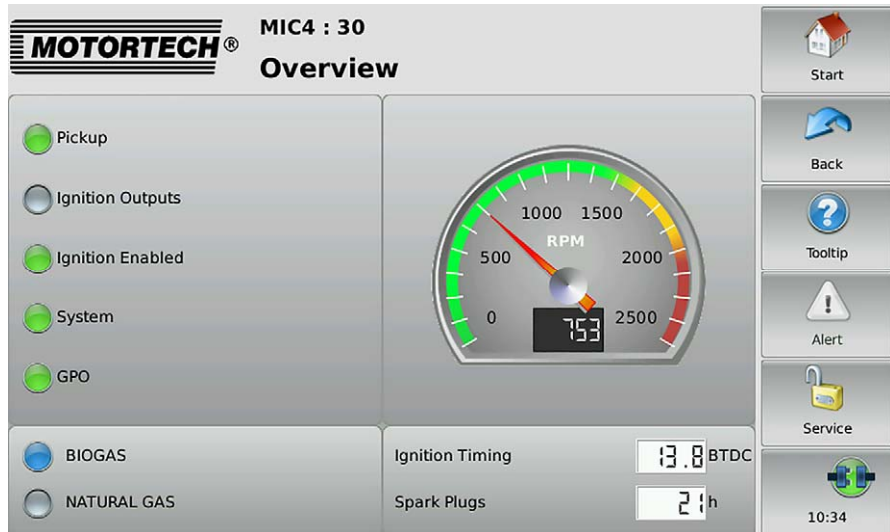

The most important operating data of the ignition controller are summarized in the view.

#### – Pickup

The status display shows whether pickup signals are being detected:

- Gray: No signals are detected.
- Yellow: The ignition controller is being synchronized to the pickup signals.
- Green: Signals are detected.

#### – Ignition Outputs

The status display shows the status of the ignition outputs of the ignition controller:

- Gray: There are no firings.
- Green: The outputs are firing without any errors.
- Yellow: There were previous misfires, but there are no misfires at present.
- Red: There are misfires.

Detailed information on ignition outputs can be found in the *Ignition* view (see section *Ignition* on page 79).

- **Ignition Enabled**  
The status display shows whether the ignition controller has received an ignition enabled command.
  - Gray: Ignition is not enabled.
  - Green: Ignition is enabled.
  - Yellow: Ignition is enabled but the ignition controller is waiting for the engine to stop.
- **System**  
The status indicator displays the system status.
  - Gray: No signal is received.
  - Green: The system works flawlessly.
  - Yellow: There are warnings or alarms, which do not lead to an engine stop.
  - Red: There are errors, which lead to an engine stop. The ignition controller is put into error condition when errors occur.
- **GPO**  
The status display displays the status of the general purpose output (GPO). The functions of the general purpose output are set in the MICT. (Further information can be found in the operating manual of your ignition controller.)
  - Green: The general purpose output is switched.
  - Gray: The general purpose output is not switched.
- **Schedule**  
The status indicator displays the active schedule of the ignition controller. If schedules have been named in the MICT, the names are displayed (for example *BIOGAS* and *NATURAL GAS*). If no names have been assigned, the schedules are called *A* and *B* in the PowerView3.
  - Gray: The schedule is not active.
  - Blue: The schedule is active.
- **Engine Speed**  
In the analog display the current engine speed is presented with a pointer and also numerically.
  - Green area: The engine speed is below nominal speed.
  - Yellow area: The engine speed is between nominal speed and overspeed.
  - Red area: overspeed
- **Ignition Timing**  
Shows the current global ignition timing in °crankshaft.
- **Spark Plugs**  
Displays the present operating hours of the spark plugs.

## 9 Devices

### 9.1.3 Timing

The *Timing* button in the *Main Menu* of the added MIC ignition controller opens the *Timing* view.

**MOTORTECH®** MIC4 : 30  
**Timing**

Global Timing Calculation			
Base Timing	20.0	BTDC	
Potentiometer Timing	0.0	ADV	49.8 %
Analog Current Input Timing	4.9	RET	19.8 mA
Analog Voltage Input Timing	0.0	RET	0.0 V
Speed Curve Correction	1.3	RET	
Timing Correction	0.0	RET	
<b>Global Timing Point</b>	<b>13.7</b>	<b>BTDC</b>	
Individual Timing			
Minimum	15.7	BTDC	
Maximum	10.7	BTDC	
Average	13.8	BTDC	

Start  
Back  
Tooltip  
Alert  
Service  
10:36

The following information is provided:

#### Global Timing Calculation

Overview of values from which the global ignition timing is calculated.

- **Base Timing**  
Shows the base timing in °crankshaft.
- **Potentiometer Timing**  
Displays the adjustment of the ignition timing via the potentiometer in °crankshaft in the direction advanced or retarded and right next to it the adjustment on the potentiometer in percent.
- **Analog Current Input Timing**  
Displays the adjustment of the ignition timing via the analog current signal in °crankshaft in direction advanced or retarded. On the right next to it, the current measured value of the analog current input is displayed in mA.
- **Analog Voltage Input Timing**  
Displays the adjustment of the ignition timing via the analog voltage signal in °crankshaft in direction advanced or retarded. On the right next to it, the current measured value of the analog voltage input is displayed in V.
- **Speed Curve Correction**  
Displays the adjustment via the speed curve in °crankshaft in direction advanced or retarded.

- **Timing Correction**  
Displays the adjustment via the ignition timing correction in °crankshaft in direction advanced or retarded.
- **Global Timing Point**  
Displays the current ignition timing in °crankshaft, which was calculated for the engine from the previously named settings.

### Individual Timing

Overview of the adjustment of the cylinder-specific ignition timing:

- **Minimum**  
Displays the minimum ignition timing in °crankshaft resulting from the cylinder-specific adjustment.
- **Maximum**  
Displays the maximum ignition timing in °crankshaft resulting from the cylinder-specific adjustment.
- **Average**  
Displays the average value of the cylinder-specific ignition timing adjustment for all cylinders in °crankshaft.

### 9.1.4 Ignition

The *Ignition* button in the *Main Menu* of the added MIC ignition controller opens the following views:

- *Ignition*
- *Misfires*

The  and  buttons allow you to switch between the views.

The views are described as follows.



#### **Cyl. / Output column**

If cylinder names have been assigned in the configuration of the ignition controller, they are displayed in the *Cyl.* column. If no cylinder names have been assigned in the configuration of the ignition controller, the *Output* column with the corresponding ignition output numbers (*A 1, A 2, ...*) is displayed instead.

## 9 Devices

### Ignition

Cyl.	Secondary Voltage [kV]	Misfire	Cyl.	Secondary Voltage [kV]	Misfire
1	20.0	Gray	6	20.6	Gray
2	20.4	Gray	4	20.0	Gray
8	20.8	Gray	3	20.8	Gray
7	20.8	Gray	5	20.0	Gray

The following information is provided:

- The estimated secondary voltage is displayed individually for every ignition output of the ignition controller.
- The status display provides information about misfires for each cylinder:
  - Gray: No misfires have been registered.
  - Yellow: There were previous misfires, but there are no misfires at present.
  - Red: Misfires occurred and there is no warning or error status.



## Misfires

Cyl.	Primary		Secondary		Cyl.	Primary		Secondary	
	Open	Short	Open	Short		Open	Short	Open	Short
1	○	○	○	○	6	○	○	○	○
2	○	○	○	○	4	○	○	○	○
8	●	○	○	○	3	○	○	○	○
7	○	○	○	○	5	●	○	○	○

You receive information on where an error has occurred in the ignition circuit:

- *Primary*: The information relates to the primary side of the ignition circuit.
- *Secondary*: The information relates to the secondary side of the ignition circuit.

You receive information on which error has occurred in the wiring of the ignition coils:

- *Open*: The ignition circuit is not closed.
- *Short*: short circuit

The status displays can show different colors:

- Gray: There are no errors.
- Red: No current misfires occur.
- Yellow: At least one misfire has occurred.
- White: The wrong ignition coils were set via the MICT or the misfire detection is unavailable for the coils selected.

With the button you can reset the misfire rate of the ignition controller.

## 9 Devices

### 9.1.5 Energy

The *Energy* button in the *Main Menu* of the added MIC ignition controller opens the *Energy* view.



#### Cyl. / Output column

If cylinder names have been assigned in the configuration of the ignition controller, they are displayed in the *Cyl.* column. If no cylinder names have been assigned in the configuration of the ignition controller, the *Output* column with the corresponding ignition output numbers (A 1, A 2, ...) is displayed instead.



Cyl.	Spark Duration [μs]	Energy Output [mJ]	Cyl.	Spark Duration [μs]	Energy Output [mJ]
1	300	280	6	300	274
2	300	274	4	300	280
8	300	276	3	300	276
7	300	280	5	300	276

This view displays the *Spark Duration* in  $\mu\text{s}$  and the *Energy Output* in mJ. The values can be used to detect possible wear of the spark plugs.

### 9.1.6 Firing Angles

The *Firing Angles* button in the *Main Menu* of the added MIC ignition controller opens the following views:

- *Firing Angles*
- *Firing Angles Drift*

The  and  buttons allow you to switch between the views.

The views are described as follows.



### Cyl. / Output column

If cylinder names have been assigned in the configuration of the ignition controller, they are displayed in the *Cyl.* column. If no cylinder names have been assigned in the configuration of the ignition controller, the *Output* column with the corresponding ignition output numbers (A 1, A 2, ...) is displayed instead.

## Firing Angles

MIC4 : 30 ▼

### Firing Angles

← →

Start

Cyl.	Firing Angle [°CRANK]		Cyl.	Firing Angle [°CRANK]	
1	13.7	BTDC	6	13.7	BTDC
2	13.7	BTDC	4	13.7	BTDC
8	13.7	BTDC	3	13.7	BTDC
7	13.7	BTDC	5	13.7	BTDC

Back

Tooltip

Alert

Service

10:36

The firing angles of the cylinders (*Cyl.*) are displayed in °crankshaft for each output of the ignition controller.

With the ▼ button you can switch the display of the firing angles:

- *Absolute*: Firing angle in °crankshaft related to the top dead center of the first cylinder in firing order
- *Relative*: Firing angle in °crankshaft related to its own top dead center

## 9 Devices

### Firing Angles Drift

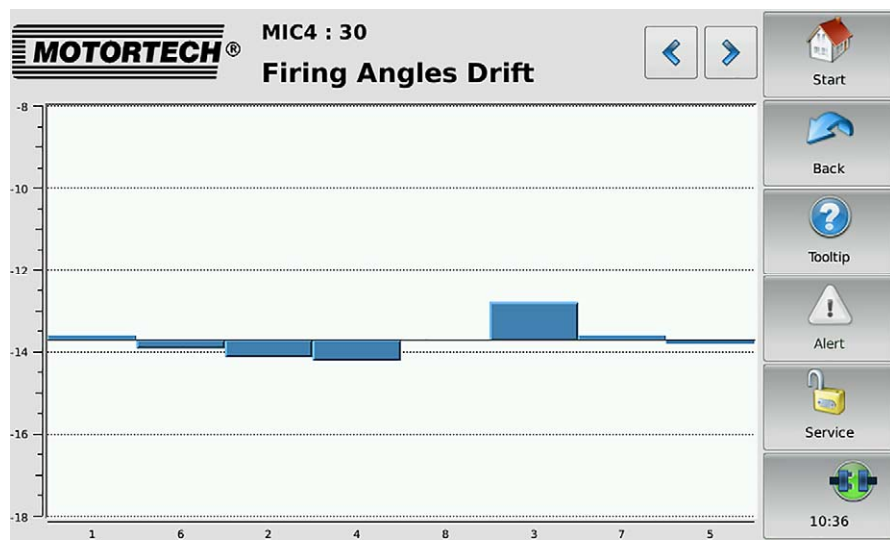



The deviations from the global ignition timing in °crankshaft are displayed in a bar chart.

### 9.1.7 Adjustments

The *Adjustments* button in the *Main Menu* of the added MIC ignition controller opens the following views:

- *Self Test*
- *Timing Adjustment*
- *Operating Hours*
- *Energy Adjustments*
- *Voltage Calibration*
- *Reset Position*
- *Cylinder Individual Offset*

The  and  buttons allow you to switch between the views.

The views are described as follows.



#### **Risk of destruction!**

Incorrect settings for energy, firing angles and the reset position can lead to damage to the engine and the ignition system. Therefore make sure that engine and ignition kit are designed for the corresponding settings.



#### **Risk of destruction!**

Changes to the settings for energy, firing angles, voltage and reset position take effect *immediately and without further confirmation*. Therefore always comply with the operating manuals of the engine and all components of the ignition kit.

## 9 Devices

### Self Test

**MOTORTECH®** MIC4 : 30  
**Self Test**

Cycle Time: 500 ms

Number of Cycles: Unlimited

Cylinder: ALL

Status: Ready for self test

Control: Start, Stop

Start, Back, Tooltip, Alert, Service, 10:37



#### Operational safety!

If you carry out a self test, it is essential for the gas supply to be switched off and no more residual gas is left in the combustion chamber. Non-compliance can result in damage to equipment or injury to persons.

You can run a self test to check the order of the wiring and the connection between the MIC ignition controller outputs down to the spark plugs.

The status display indicates whether the ignition controller is ready for the self test.

- Red: The ignition controller is in a state in which no self test can be done. For example, there is an error or a configuration is currently being downloaded into the device.
- Yellow: The self test is running.
- Green: The ignition controller is ready and the self test can be started.

Carry out the self test as follows:

1. Stop the gas supply to the engine.
2. Purge the engine.
  - ▶ The engine is ready for the self test.
3. Set the *Cycle Time* (the interval between the two ignitions).
4. Define via the *Number of Cycles* whether the self test is to run *Unlimited* or whether it should be ended after a defined number of cycles.
5. Define whether *All* outputs or only a defined output should be fired during the self test.
6. Start the self test via the *Start* button.
  - ▶ The self test runs until it is stopped. In the meantime you can inspect the data received in other views.
7. End the self test via the *Stop* button.
  - ▶ The self test is concluded.

### Timing Adjustment

**MOTORTECH®** MIC4 : 30  
**Timing Adjustment**

Timing Correction [°CRANK] 0.1 RET  
Global Timing Point [°CRANK] 13.8 BTDC

-0.5 -0.1 +0.1 +0.5

Start  
Back  
Tooltip  
Alert  
Service  
10:37

Via the corresponding buttons, the global ignition timing can be corrected in 0.1° or 0.5° increments to advance or retard.

## 9 Devices

### Operating Hours

The screenshot shows the MOTORTECH Operating Hours control interface. At the top left is the MOTORTECH logo. To its right, the text "MIC4 : 30" is displayed. Below this, the title "Operating Hours" is centered. On the right side of the top bar are two navigation arrows (left and right). A vertical sidebar on the far right contains several icons: a house for "Start", a blue arrow for "Back", a question mark for "Tooltip", a warning triangle for "Alert", a padlock for "Service", and a clock for "10:37". The main area is divided into two sections: "Spark Plugs" and "Engine". The "Spark Plugs" section has a digital display showing "21", a downward arrow, an upward arrow, and a "Reset" button. The "Engine" section has a digital display showing "30", a downward arrow, an upward arrow, and a "Reset" button.

Set the operating hours of the spark plugs or the engine to the desired value using the arrow keys. You can reset the value of the operating hours for the spark plugs and the motor to 0 with the *Reset* buttons.



## Energy Adjustments

**MOTORTECH® MIC4 : 30**

### Energy Adjustments

Schedule A - BIOGAS

Spark Duration:  µs

Spark Intensity:  mA

Schedule B - NATURAL GAS

Spark Duration:  µs

Spark Intensity:  mA

Start

Back

Tooltip

Alert

Service

10:37

In this view, you have the following options:

- The *Spark Duration* for the schedules can be lowered or increased via the corresponding buttons by 1 µs or 5 µs.
- The *Spark Intensity* for the schedules can be lowered or increased via the corresponding buttons by 1 mA or 5 mA.

## 9 Devices

### Voltage Calibration



**MOTORTECH** MIC4 : 30  
**Voltage Calibration**

A1	0.0	A2	0.0	B1	0.2	B2	0.0
A3	0.2	A4	-0.5	B3	0.0	B4	0.0
A5	0.6	A6	0.0	B5	0.1	B6	-0.3
A7	0.0	A8	0.0	B7	0.0	B8	0.4

Buttons: Start, Back, Tooltip, Alert, Service, 11:23

In this view, you can set a unitless correction value for the secondary voltage estimation for each output.

Changes are made to selected outputs. You have the following options for selecting outputs:

- Tap the desired output directly to select it. To remove the output from the selection, tap the output again.
- Tap a group symbol (e. g. ) to reverse the selection of the respective group.
  - ▶ Selected outputs have a blue frame.
- Tap  to clear all selections. .

For the selected outputs, set the correction value using the arrow keys:

- With  and  in steps of 0.1
- With  and  in steps of 0.5

## Reset Position

**MOTORTECH** MIC4 : 30  
**Reset Position**

Reset [°CRANK] **57.0** ADV

0.5 ADV 0.1 ADV 0.1 RET 0.5 RET

Start  
Back  
Tooltip  
Alert  
Service  
10:37

Using the arrow keys, correct the index/reset position (*Reset*) in steps of 0.1 °crankshaft or 0.5 °crankshaft to advance or retard. If the correction range is not sufficient, the reset/index position must be adjusted in the configuration in the MICT.

## 9 Devices

### Cylinder Individual Offset

**MOTORTECH**® MIC4 : 30  
**Cylinder Individual Offset**



A1	1.0	A2	0.0	B1	0.5	B2	0.0
A3	0.3	A4	-0.5	B3	0.0	B4	0.0
A5	0.1	A6	0.2	B5	0.2	B6	0.2
A7	0.9	A8	0.0	B7	0.0	B8	0.3

[°]

Start  
Back  
Tooltip  
Alert  
Service  
11:25

In this view, you can adjust the ignition timing position for each cylinder individually.

Changes are made to selected outputs. You have the following options for selecting outputs:

- Tap the desired output directly to select it. To remove the output from the selection, tap the output again.
- Tap a group symbol (e. g. ) to reverse the selection of the respective group.
  - ▶ Selected outputs have a blue frame.
- Tap  to clear all selections.

For the selected outputs, set the correction value using the arrow keys:

- With  and  in steps of  $0.1^\circ$
- With  and  in steps of  $0.5^\circ$

## 9.1.8 Trends

The *Trends* button in the *Main Menu* of the added MIC ignition controller opens the *Trends* view.



To view the firing angles or secondary voltages trend, tap the desired button.

## 9 Devices

### Firing Angles

The *Firing Angles* button in the *Trends* view of the added MIC ignition controller opens the *Firing Angles* view.

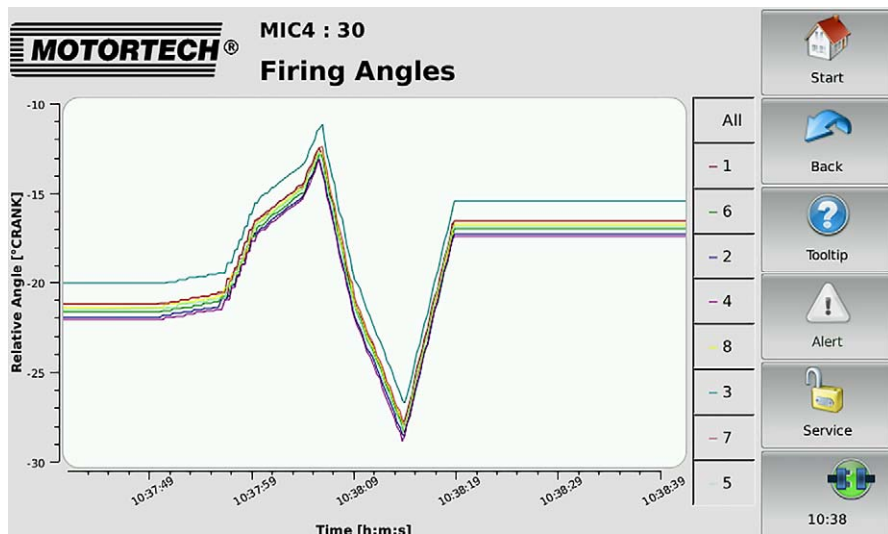

You receive information on the trend of the firing angles. The cylinders can be displayed and hidden individually via the legend.

## Secondary Voltage

The *High Voltages* button in the *Trends* view of the added MIC ignition controller opens the *Secondary Voltage* view.

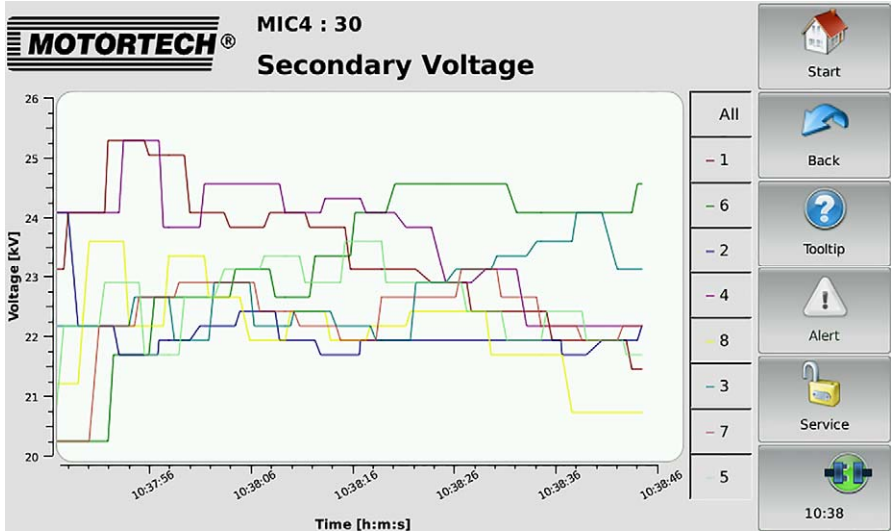



You get information on the secondary voltages trend. The cylinders can be displayed and hidden individually via the legend.

## 9 Devices

### 9.1.9 Message Log

The *Message Log* button in the *Main Menu* of the added MIC ignition controller opens the following views:

- *States*
- *Message Log*

The  and  buttons allow you to switch between the views.

The views are described as follows.

#### States

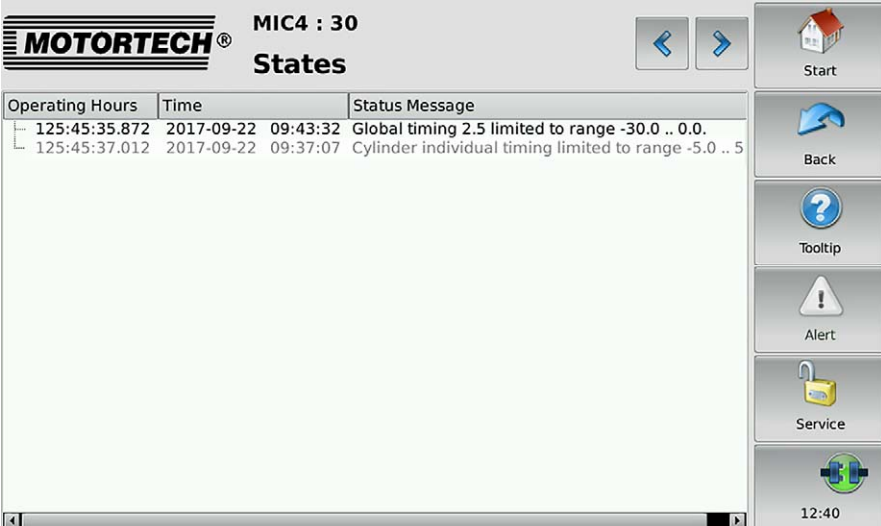

MOTORTECH® MIC4 : 30  
**States**

Operating Hours	Time	Status Message
125:45:35.872	2017-09-22 09:43:32	Global timing 2.5 limited to range -30.0 .. 0.0.
125:45:37.012	2017-09-22 09:37:07	Cylinder individual timing limited to range -5.0 .. 5

Start  
Back  
Tooltip  
Alert  
Service  
12:40

Status messages are listed in the *States* view.

The following information is provided:

- *Operating Hours*: operating hours counter reading at the time of message
- *Time*: date and time of the message
- *Status Message*: message text

Status messages are displayed in black if they are current. If a status is reset, the status message is displayed gray for 10 seconds before it is deleted from the list.



## Message Log

Operating Hours	Time	Category	Message
125:44:39.279	2015-11-12 13:39:08	Info	CANopen on interface CAN2 changed
125:44:39.280	2015-11-12 13:39:08	Info	CANopen on interface CAN2 changed
125:44:39.280	2015-11-12 13:39:08	Info	CANopen on interface CAN2 changed
125:44:39.525	2015-11-12 13:39:09	Info	J1939 on interface CAN1 changed sta
125:44:40.888	2015-11-12 13:39:10	Info	CANopen on interface CAN2 changed
125:45:29.206	2015-11-12 13:39:58	Error	Number of trigger signals (179) coun
125:45:29.207	2015-11-12 13:39:58	Error	Operational error caused by pickup s
125:45:48.110	2015-11-12 13:40:17	Info	Device switched off.
125:45:49.376	2015-11-12 13:40:21	Info	Device (firmware 1.0.1.21538) starte
125:45:49.376	2015-11-12 13:40:21	Info	J1939 on interface CAN1 changed sta
125:45:49.378	2015-11-12 13:40:21	Info	CANopen on interface CAN2 changed
125:45:49.384	2015-11-12 13:40:21	Info	CANopen on interface CAN2 changed
125:45:49.386	2015-11-12 13:40:21	Info	CANopen on interface CAN2 changed
125:45:49.386	2015-11-12 13:40:21	Info	CANopen on interface CAN2 changed
125:45:49.635	2015-11-12 13:40:22	Info	J1939 on interface CAN1 changed sta
125:45:50.574	2015-11-12 13:40:23	Info	CANopen on interface CAN2 changed
129:27:21.961	2015-11-12 17:21:57	Info	Configuration changed.
129:27:21.966	2015-11-12 17:21:57	Alarm	All alarms reset.
129:29:49.072	2015-11-12 17:24:24	Error	Cycle signal was missing, so that mo
129:29:49.073	2015-11-12 17:24:24	Error	Operational error caused by pickup s

The *Message Log* view lists information, alarms, warnings, and errors (works with ignition controller MIC4 Version 0.16 and higher).

The following information is provided:

- *Operating Hours*: operating hours counter reading at the time of message
- *Time*: date and time of the message
- *Category*: type of message (information, warning, error, alarm)
- *Message*: message text

With the button you open the menu *Actions*. You have the following options:

- Acknowledge alarms
- Acknowledge operational errors
- Switch automatic scrolling on and off

## 9 Devices

### 9.1.10 Diagnosis

The *Diagnosis* button in the *Main Menu* of the added MIC ignition controller opens the *Diagnosis* view.

**MOTORTECH®** MIC4 : 30  
**Diagnosis**

**Temperatures**  
Controller Board 40.3 °C    Output Board 34.5 °C

**Voltages**  
Supply Voltage 23.9 V

**Operating Hours**  
Device 123:43    Engine 30  
Spark Plugs 21    Engine Total 30

Start  
Back  
Tooltip  
Alert  
Service  
10:38

In the *Diagnosis* view information on the operating values of the ignition controller is displayed:

#### Temperatures

Overview of the temperatures of the ignition controller

- [Controller Board](#)  
Temperature of the controller board
- [Output Board](#)  
Temperature of the outboard board



#### Switching between °C and °F

In the display configuration, you can specify whether the temperatures are displayed in °C or in °F (see section *Display* on page 57).

#### Voltages

Information on the supply voltage of the ignition controller

### Operating Hours

The operating time of the ignition controller is displayed in hours and minutes. The operating time of the engine and the spark plugs is displayed in hours.

- **Device**  
Total operating time of the ignition controller
- **Spark Plugs**  
Operating hours of the spark plugs used
- **Engine**  
Operating hours of the engine since the last start-up
- **Engine Total**  
Total operating hours of the engine with the ignition controller

### 9.1.11 Information

The *Information* button in the *Main Menu* of the added MIC ignition controller opens the *Information* view.

Hardware	
Device ID	1.5.1
Revision	1.4.0.19856
Serial Number	01011134
Arrangement	421.08.C000-000-AA-4

Software Version	
Bootloader	0.26.2.20138
Firmware	1.0.1.21538
Coil Data	1

The screenshot also shows a sidebar on the right with the following buttons: Start (house icon), Back (blue arrow icon), Tooltip (question mark icon), Alert (warning triangle icon), Service (yellow padlock icon), and a clock showing 10:38.

## 9 Devices

In the *Information* view, hard and software data of the MIC ignition controller are displayed:

### Hardware

Overview of the hardware of the connected MIC ignition controller

- **Device ID**  
The identification number of the device provides information on type and subtype of the MOTORTECH device.
- **Revision**  
Hardware revision number of the device
- **Serial Number**  
The unique serial number is assigned once to each device.
- **Arrangement**  
The arrangement number comprises the type and sub-type of the ignition controller.

### Software Version

Information on the software of the MIC ignition controller

- **Bootloader**  
Version number of the bootloader
- **Firmware**  
Version number of the firmware of the device
- **Coil Data**  
The coil data version configured in the ignition controller

## 9.2 DetCon Detonation Controller

This section describes the functions of the device menu for an added DetCon detonation controller.

### 9.2.1 Main Menu

The main menu of an added DetCon detonation controller is opened in the *Start Menu* via the button *DetCon2/20* or *DetCon16*.



The main menu has the following buttons:

- **Overview**  
With the button you obtain information on the most important operating data. There is more information in the section *Overview* on page 102.
- **Intensity**  
With the button you receive information on the knocking intensity of each cylinder. There is more information in the section *Intensity* on page 104.
- **Trends**  
With the button you gain access to the knocking intensity and analog output signal trend. There is more information in the section *Trends* on page 105.
- **Preferences**  
This button gives you access to the settings for processing the DetCon detonation controller signals. There is more information in the section *Preferences* on page 108.

## 9 Devices

### – Help

This button opens the operating manual of the DetCon detonation controller. There is more information in the section *Help* on page 73.

### 9.2.2 Overview

The *Overview* button in the *Main Menu* of the added DetCon detonation controller opens the *Overview*.

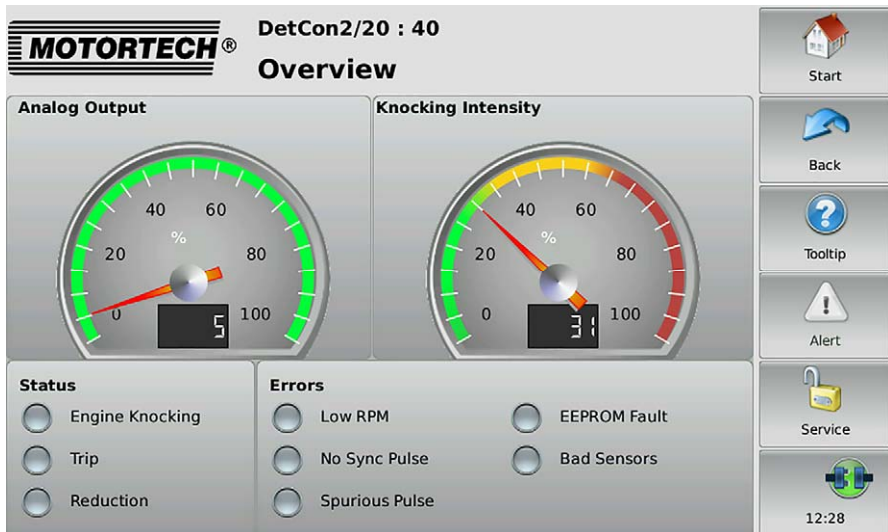

The most important operating data of the detonation control are summarized in the view.

### – Analog Output

The current analog output signal strength is presented in percent with a pointer and also numerically in the display.

### – Knocking Intensity

The maximum knocking intensity measured is presented in percent with a pointer and also numerically in the display.

- Green area: The knock level is below the *Ignition reduction limit* configured in the DetCon.
- Yellow area: The knock level is above the *Ignition reduction limit* configured in the DetCon.
- Red area: The knock level is above the limit for an emergency stop.

In the field *Status* the operating condition of the DetCon detonation controller is presented via status displays:

- **Engine Knocking**  
A yellow status display indicates that the knock level is above the *Ignition reduction limit* configured in the DetCon.
- **Trip**  
If the output TRIP at the DetCon detonation controller is configured as "normally open", a red status display indicates that the knock level is above the limit for an emergency stop. If the output TRIP at the DetCon is configured as "normally closed", a red status display indicates that the knock level is below the limit for an emergency stop. If needed, the status display *Trip* in the PowerView<sub>3</sub> can be inverted (see section *Preferences* on page 108).
- **Reduction**  
A yellow status display indicates that the reduction of the knock level via the analog output signal has exceeded the maximum value. The load reduction is activated.

In the field *Errors*, errors of the DetCon detonation controller are indicated via status displays:

- **Low RPM**  
A yellow status display indicates that the detonation control is ineffective on account of insufficient speed.
- **No Sync Pulse**  
A red status display indicates that no pulses are being detected at the ignition input of the detonation controller.
- **Spurious Pulse**  
A red status display indicates that the detonation sensor signals are disrupted.
- **EEPROM Fault**  
A red status display indicates that configuration data is defective.
- **Bad Sensors**  
A red status display indicates that one or more sensors are not connected.

## 9 Devices

### 9.2.3 Intensity

The *Intensity* button in the *Main Menu* of the added DetCon detonation controller opens the *Knocking Intensity* view.

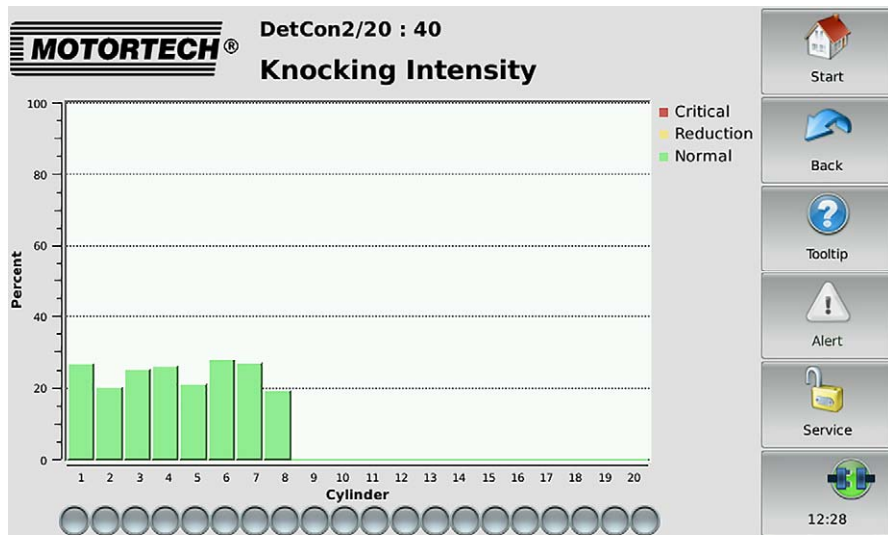

In the *Knocking Intensity* view the knocking intensity is shown in percent for each cylinder monitored.

The colors of the bars have the following meanings:

Color	Meaning	Explanation
Green	Normal	The detonation controller is not registering any excessive knocking intensity.
Yellow	Reduction	The detonation controller is reducing knocking.
Red	Critical	The knocking intensity is so high that the engine must be immediately shut down.

A red status display indicates a sensor error.



## 9.2.4 Trends

The *Trends* button in the *Main Menu* of the added DetCon detonation controller opens the *Trends* view.



To view the knocking intensity trend or the analog output signal trend, tap the desired button.

## 9 Devices

### Knocking Intensity

The *Knocking* button in the *Trends* view of the added DetCon detonation controller opens the *Knocking Intensity* view.

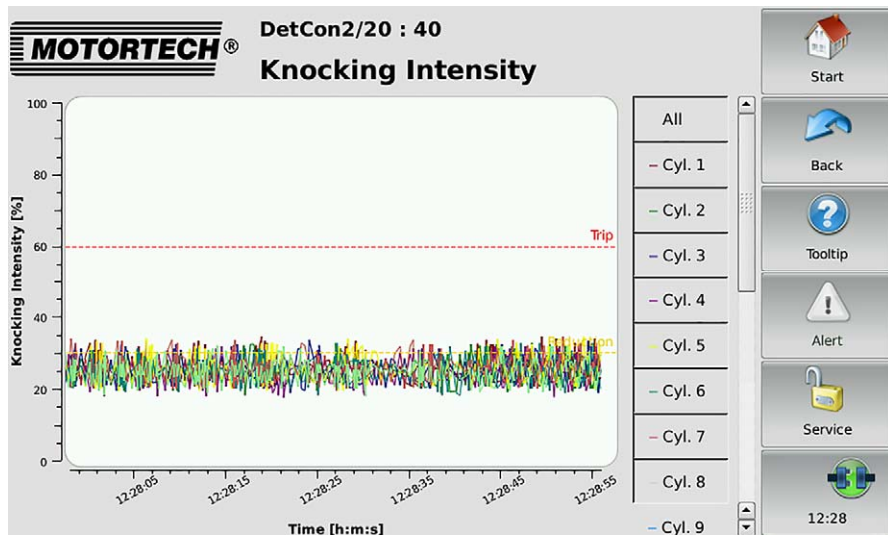

In this view the knocking intensity trend of all cylinders is presented. The cylinders are presented in different colors and can be removed and reconnected individually from the view via the buttons to the right next to the display window.

The areas have the following meaning:

Area	Meaning
From 0 to the yellow line <i>Reduction</i>	The detonation controller is not registering any excessive knocking intensity.
From the yellow line <i>Reduction</i> to the red line <i>Trip</i>	The detonation controller is reducing knocking.
From the red line <i>Trip</i> to 100	The knocking intensity is so high that the engine must be immediately shut down.

## Analog Output

The *Analog Output* button in the *Trends* view of the added DetCon detonation controller opens the *Analog Output* view.

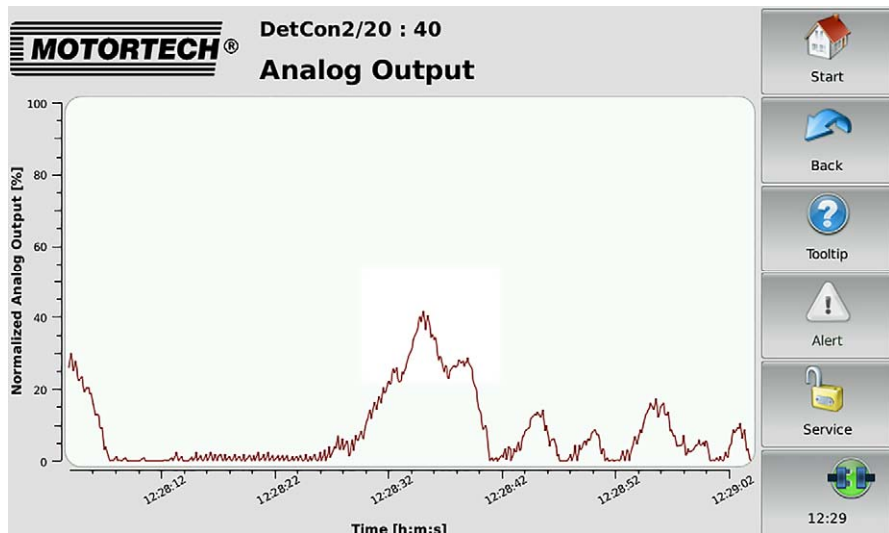

The diagram indicates the trend of the analog output signal in percent.

## 9 Devices

### 9.2.5 Preferences

The *Preferences* button in the *Main Menu* of the added DetCon detonation controller opens the *Preferences* view.

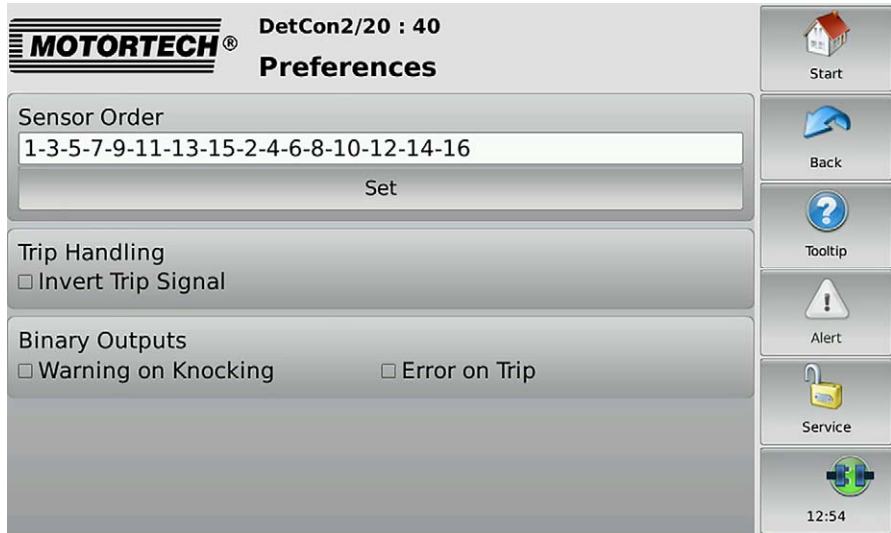

In this view you change the settings for processing the signals that the PowerView3 receives from the DetCon detonation controller.

#### Sensor Order

In the factory settings, the knocking intensity of all cylinders is displayed in the *Knocking Intensity* view (see section *Intensity* on page 104). The sequence depends on the DetCon detonation controller sensor output that the relevant detonation sensor is connected to. Tap *Set* to change the sequence or to display the knocking intensity of only a selection of the sensors.

#### Trip Handling

Activate the checkbox to invert the status display *Trip* in the *Overview* of the DetCon detonation controller (see section *Overview* on page 102). This setting does not change the setting of the *Trip contact inactive* entry in the DetCon detonation controller.

#### Binary Outputs

If the binary outputs of the PowerView3 are activated in the *Device Setup* view (see section *Devices* on page 51), you can activate the following messages:

- **Warning on Knocking**  
If the DetCon detonation controller registers engine knocking, binary output 1 (Warning) is switched on the PowerView3.

- **Error on Trip**

If the *Trip* output is activated on the DetCon detonation controller, binary output 2 (Error) is switched on the PowerView3.



### **Operational safety!**

The PowerView3 and the software are not designed for safety-critical applications. The binary inputs and outputs of the PowerView3 must not be used for safety-critical purposes.

## 9 Devices

### 9.3 TempScan Temperature Module

This section describes the functions of the device menu for an added temperature module TempScanzo.



#### Switching between °C and °F

In the display configuration, you can specify whether the temperatures are displayed in °C or in °F (see section *Display* on page 57).

#### 9.3.1 Main Menu

The main menu of an added TempScan temperature module can be opened in the *Start Menu* via the *TempScanzo* button.





The main menu has the following buttons:

- **Overview**  
This button opens the *Overview* in which all currently measured temperatures are listed. There is more information in the section *Overview* on page 112.

- **Preferences**  
This button opens the *Preferences* view from which you can access all of the configuration pages for your TempScan temperature module. There is more information in the section *Preferences* on page 113.
- **Help**  
This button opens the operating manual of TempScan temperature module. There is more information in the section *Help* on page 73.

If a group has at least one activated channel assigned to it, additional buttons for opening group-specific views are displayed in the *Main Menu*. The buttons are labeled with the name of the group (here: *Bank A*).

Button	Function
 <p>Bank A</p>	With this button you can open an overview with the measured temperatures of all channels in a group (see <i>Overview</i> on page 126).
 <p>Bank A</p>	With this button you can open a view with the temperature trends of all channels in a group (see <i>Temperatures</i> on page 127).
 <p>Bank A Ø</p>	This button is only displayed if the checkbox <i>Average</i> in the <i>Group Names</i> view is activated (see <i>Groups</i> on page 116). The deviation of each channel from the average temperature of all group channels is displayed (see <i>Average Deviation</i> on page 128).

## 9 Devices

### 9.3.2 Overview

The *Overview* button in the *Main Menu* of the added TempScan temperature module opens the *Overview*.

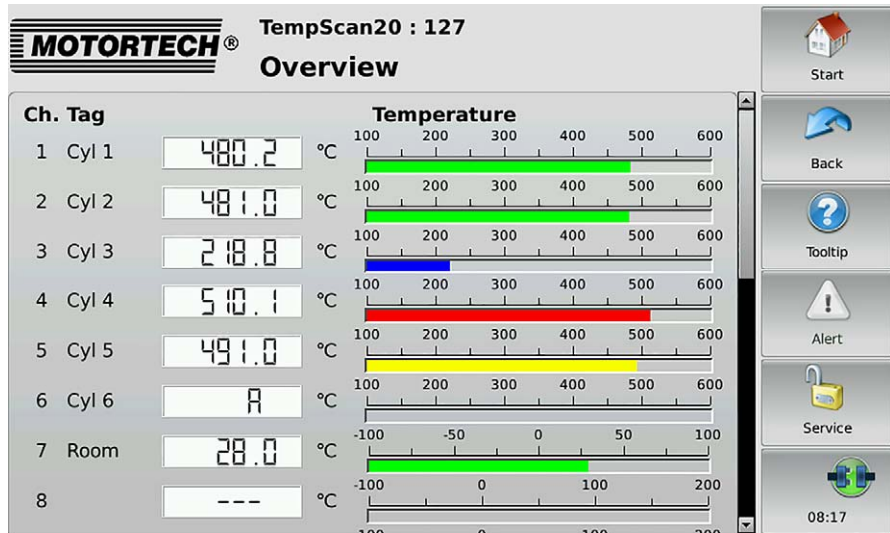

This view lists all the channels of the TempScan temperature module:

- *Ch.*: channel number
- *Tag*: user-specified abbreviation
- Currently measured *Temperature* (A = thermocouple failed; --- = channel not activated)

The colors of the temperature displays have the following meaning:

- Green: The temperature is within the permitted range.
- Blue: The temperature has dropped below the lower warning threshold.
- Yellow: The upper warning threshold has been exceeded.
- Red: The upper shutdown threshold has been exceeded.

Information about setting thresholds can be found in section *Thresholds* on page 122.



### 9.3.3 Preferences

The *Preferences* button in the *Main Menu* of the added TempScan temperature module opens the *Preferences* view.



The *Preferences* view contains the following buttons:

- **Names**  
This button opens the *Channel Names* view, in which you can assign names to the available channels. There is more information in the section *Names* on page 114.
- **Groups**  
This button opens the *Group Names* view, in which you can assign names to the available groups. There is more information in the section *Groups* on page 116.
- **Channels**  
This button opens the views for configuring the individual channels. There is more information in the section *Channels* on page 117.
- **Type**  
This button opens the *Thermocouples* view, which allows you to set the thermocouple type for each channel. There is more information in the section *Type* on page 120.
- **Activation**  
This button opens the *Channel Activation* view, in which you can activate and deactivate individual channels for the display of measured values and assign them to groups. There is more information in the section *Activation* on page 121.

## 9 Devices

- **Thresholds**  
This button opens the views for configuring the warning and shutdown thresholds. There is more information in the section *Thresholds* on page 122.
- **Internal Status**  
This button opens views, in which you can access internal parameters of the TempScan temperature module. There is more information in the section *Internal Status* on page 124.
- **Store Setup**  
Tap this button to permanently save the following information in the TempScan temperature module:
  - Warning and shutdown thresholds
  - Thermocouple types
  - The information whether a channel is activated or deactivated.

Otherwise, this information will be lost in the TempScan temperature module if the temperature module is switched off temporarily and is not connected to the PowerView3 after switching on.

### 9.3.3.1 Names

The *Names* button in the *Preferences* view of the added TempScan temperature module opens the *Channel Names* view.

Ch.	Tag	Name	Advanced Settings
1	Cyl 1	Cylinder 1	Configure Channel
2	Cyl 2	Cylinder 2	Configure Channel
3	Cyl 3	Cylinder 3	Configure Channel
4	Cyl 4	Cylinder 4	Configure Channel
5	Cyl 5	Cylinder 5	Configure Channel
6	Cyl 6	Cylinder 6	Configure Channel
7	Room	Room Temperature	Configure Channel
8	none	none	Configure Channel
9	none	none	Configure Channel
10	none	none	Configure Channel
11	none	none	Configure Channel
12	none	none	Configure Channel

This view lists all the channels of the TempScan temperature module. You have the following options:

### Tag

To enter an abbreviation, proceed as follows:

1. Tap the desired field in the *Tag* column.
2. Enter an abbreviation (maximum five characters) via the on-screen keyboard and confirm with *OK*.
  - ▶ The abbreviation is displayed and then always used in the user interface of the PowerView3 if there is insufficient space for the full name.

### Name

Name the channel as follows:

1. Tap the desired field in the *Name* column.
2. Enter a channel name (maximum 20 characters) via the on-screen keyboard and confirm with *OK*.
  - ▶ The name is displayed.

### Advanced Settings

The *Configure Channel* button opens the channel settings. There you can edit all the settings of the respective channel (see section *Channels* on page 117).

## 9 Devices

### 9.3.3.2 Groups

The *Groups* button in the *Preferences* view of the added TempScan temperature module opens the *Group Names* view.

Label	Group Name	Average
A	Bank A	<input checked="" type="checkbox"/> Enabled
B	Bank B	<input checked="" type="checkbox"/> Enabled
C	Room	<input checked="" type="checkbox"/> Enabled
D	none	<input type="checkbox"/> Enabled

Up to four groups (labels A to D) can be assigned to the channels of the TempScan temperature module. For each group with at least one assigned channel, additional group-specific views are available, which can be accessed via the *Main Menu* of the temperature module (see *Group-Specific Views* on page 125).

In this view, you can assign group names and activate the display of average temperature deviations for each group:

#### Group Name

Name the groups A to D as follows:

1. Tap the desired field in the *Group Name* column.
2. Enter a group name (maximum eleven characters) via the on-screen keyboard and confirm with *OK*.
  - ▶ The group name is displayed.

## Average

The deviation of each individual channel in the group from the average group temperature can be displayed via the PowerView3. For this, activate the desired checkbox in the *Average* column. If the checkbox is activated for a group, the following additional button with the corresponding group name is available in the *Main Menu* of the temperature module:



This button opens the view in which the average temperature deviations within the group are displayed. Read the section *Average Deviation* on page 128 for more information.

### 9.3.3.3 Channels

The *Channels* button in the *Preferences* view of the added TempScan temperature module opens views for individual configuration of the single channels. In each view, you make all the settings for one channel.

The and buttons allow you to switch between the channels.

The configured channel is always the one shown in the title area.

## 9 Devices

### Tag

To enter an abbreviation, proceed as follows:

1. Tap in the field below *Tag*.
2. Enter an abbreviation (maximum five characters) via the on-screen keyboard and confirm with *OK*.
  - ▶ The abbreviation is displayed and then always used in the user interface of the PowerView3 if there is insufficient space for the full name.

### Name

Name the channel as follows:

1. Tap in the field below *Name*.
2. Enter a channel name (maximum 20 characters) via the on-screen keyboard and confirm with *OK*.
  - ▶ The name is displayed.

### Thermocouple

Set the thermocouple type that is connected to the channel of the TempScan temperature module accordingly.

### Status

In the *Status* area you have the following options:

- Activate the checkbox *Channel Enabled* to activate the displayed channel for displaying measured values in the PowerView3.
- Activate the checkbox *Warning Output*, so that binary output 1 (Warning) is activated for the displayed channel if the warning thresholds are not met.
- Activate the checkbox *Error Output*, so that binary output 2 (Error) is activated for the displayed channel if the shutdown threshold is not met.

### Group

Assign a channel to one or several groups. Activate the checkbox for the desired groups.

### Limits

The PowerView3 switches the binary output 1 (Warning) when warning thresholds are not met and the binary output 2 (Error) when shutdown thresholds are not met, if the following prerequisites are fulfilled:

- ▶ The binary outputs are activated in the PowerView3 (see section *Devices* on page 51).
- ▶ At least one channel is activated.
- ▶ At least the checkbox *Warning Output* or *Error Output* is activated.

The colors of the temperature displays in the *Overview* and in the group-specific views are dependent on the threshold settings (see sections *Overview* on page 112 and *Group-Specific Views* on page 125).

You can set the following threshold values:

- *Shutdown High* defines the upper shutdown threshold value.
- *Warning High* defines the upper warning threshold value.
- *Warning Low* defines the lower warning threshold value.

Adjust the threshold values as follows:

- With  and  in steps of 1 °C or 1 °F
- With  and  in steps of 20 °C or 20 °F

To save the set warning and shutdown thresholds, thermocouple types and channel activations permanently in the TempScan temperature module, use the *Back* button to go back to the *Preferences* view and tap the *Store Setup* button.



### Minimum separation of threshold values

The threshold values *Shutdown High*, *Warning High* and *Warning Low* must each be separated by at least 10 °C (18 °F).

## 9 Devices

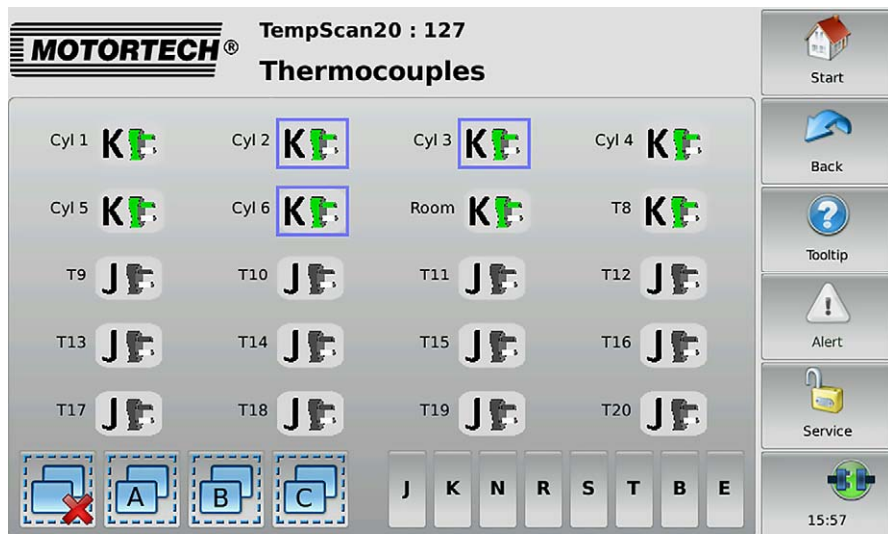

### 9.3-3.4 Type

The *Type* button in the *Preferences* view of the added TempScan temperature module opens the *Thermocouples* view.



In this view, you can set the thermocouple type connected to the temperature module for each channel. The colors of the thermocouple types shown correspond to the standard IEC 60584-3:2007.

Changes are made to selected channels. You have the following options for selecting channels:

- Tap the desired channel directly to select it. To remove the channel from the selection, tap the channel again.
- Tap a group symbol (e. g. ) to reverse the selection of the respective group.
  - ▶ Selected channels have a blue frame.
- Tap  to clear all selections.

For the selection, set the desired thermocouple type by pressing the corresponding button (for example *K* or *J*).



To save the set thermocouple types permanently in the TempScan temperature module, use the *Back* button to go back to the *Preferences* view and tap the *Store Setup* button.



## 9.3.3.5 Activation

The *Activation* button in the *Preferences* view of the added TempScan temperature module opens the following views:

- *Channel Activation*
- *Warning Output*
- *Error Output*
- *to Group x* (A, B, C, D or configured group name)

The  and  buttons allow you to switch between the views.

The views are described as follows.

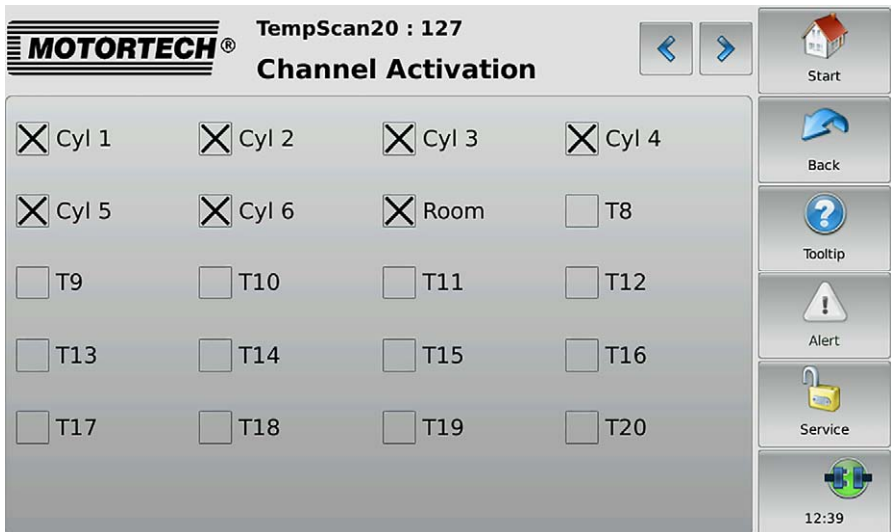

All channels are displayed with their numbers or an abbreviation (if available).

### Channel Activation

Activate the checkbox of the desired channels to activate them for the display of measured values in the PowerView3.

To save the set channel activation permanently in the TempScan temperature module, use the *Back* button to go back to the *Preferences* view and tap the *Store Setup* button.

### Warning Output

Activate the checkbox of the desired channels if the binary output 1 (Warning) of the PowerView3 is to be switched when warning thresholds are not met.

## 9 Devices

### Error Output

Activate the checkbox of the desired channels if the binary output 2 (Error) of the PowerView3 is to be switched when error thresholds are not met.



### to Group x

Activate the checkbox of the channels that you want to assign to the displayed group (A, B, C, D or configured group name).

### 9.3.3.6 Thresholds

The *Thresholds* button in the *Preferences* view of the added TempScan temperature module opens the following views:

- *High Temp. Shutdown*: Defines the upper shutdown thresholds (*Shutdown High* in *Settings Channel x* view).
- *High Temp. Warning*: Defines the upper warning thresholds (*Warning High* in *Settings Channel x* view).
- *Low Temp. Warning*: Defines the lower warning thresholds (*Warning Low* in *Settings Channel x* view).

The  and  buttons allow you to switch between the views.

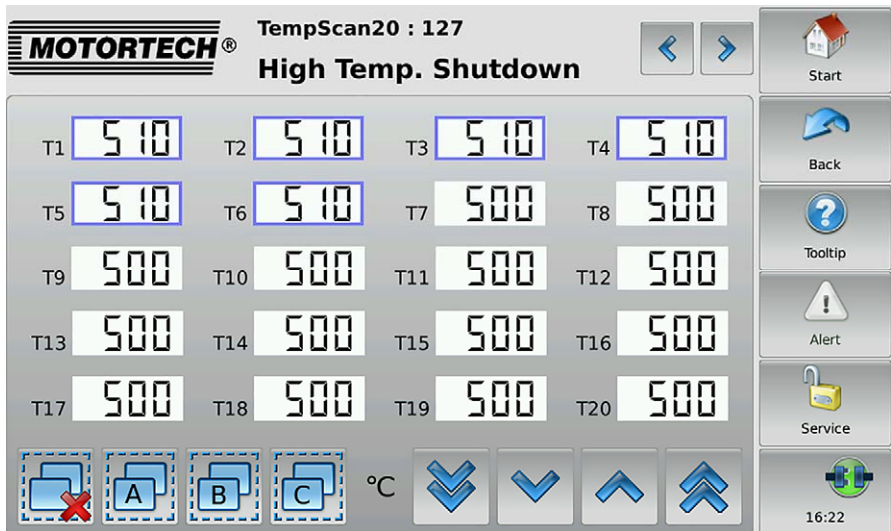

**MOTORTECH®** TempScan20 : 127  
**High Temp. Shutdown**

T1	510	T2	510	T3	510	T4	510
T5	510	T6	510	T7	500	T8	500
T9	500	T10	500	T11	500	T12	500
T13	500	T14	500	T15	500	T16	500
T17	500	T18	500	T19	500	T20	500

°C



Start  
Back  
Tooltip  
Alert  
Service  
16:22

The PowerView3 switches the binary output 1 (Warning) when warning thresholds are not met and the binary output 2 (Error) when shutdown thresholds are not met, if the following prerequisites are fulfilled:

- The binary outputs are activated in the PowerView3 (see section *Devices* on page 51).
- At least one channel is activated (see section *Activation* on page 121 or *Channels* on page 117).
- At least the checkbox *Warning Output* or *Error Output* is activated (see section *Channels* on page 117).

The colors of the temperature displays in the *Overview* and in the group-specific views are dependent on the threshold settings (see sections *Overview* on page 112 and *Group-Specific Views* on page 125).

Changes are made to selected channels. You have the following options for selecting channels:

- Tap the desired channel directly to select it. To remove the channel from the selection, tap the channel again.
- Tap a group symbol (e. g. ) to reverse the selection of the respective group.
  - ▶ Selected channels have a blue frame.
- Tap  to clear all selections.

For the selected outputs, set the thresholds using the arrow keys:

- With  and  in steps of 1 °C or 1 °F
- With  and  in steps of 20 °C or 20 °F

To save the set warning and shutdown thresholds permanently in the TempScan temperature module, use the *Back* button to go back to the *Preferences* view and tap the *Store Setup* button.



### Minimum separation of threshold values



The threshold values *High Temp. Shutdown*, *High Temp. Warning* and *Low Temp. Warning* must each be separated by at least 10 °C (18 °F).

## 9 Devices

### 9.3.3.7 Internal Status

The *Internal Status* button in the *Preferences* view of the added TempScan temperature module opens the following views:

- *Status*
- *Reference Junction*

The  and  buttons allow you to switch between the views.

These views support service personnel when troubleshooting and are described in the following.

#### Status



Parameter	Value
Error React Delay [ms]	5000
Power Supply Measured [V]	800
ADC Filter Frequency [Hz]	50
Start in Operational Mode	0

The following information is provided:

- **Error React Delay [ms]**  
Time span after which the TempScan temperature module sends an error message if a warning or shutdown threshold is not met.
- **Power Supply Measured [V]**  
The internal supply voltage varies depending on the external supply voltage of the PowerView3.
- **ADC Filter Frequency [Hz]**  
Information on the filter frequency of the inputs of the TempScan temperature module.

- **Start in Operational Mode**

This entry must show the value 0 so that the TempScan temperature module does not start in operational mode and can be configured at any time via the PowerView3. If any other value occurs, contact MOTORTECH service.

### Reference Junction

	Channels 1-10	Channels 11-20
Input Field Value [°C]	3163	32.20
Auto Correct on [bits]	3FF	3FF

The following information is provided:

- **Input Field Value [°C]**

In order to determine a temperature with thermocouples, you need a reference junction temperature. This entry provides information on the current temperature measured by the reference junction.

- **Auto Correct on [bits]**

The hexadecimal number 3FF indicates that the reference junction temperature is used to determine the temperature with the thermocouples. If any other value occurs, contact MOTORTECH service.

### 9.3.4 Group-Specific Views

If at least one activated channel is assigned to a group, you can open the following views via additional buttons in the *Main Menu* of the added TempScan temperature module.

## 9 Devices

### 9.3.4.1 Overview

The *Overview* of a group (here: *Bank A*) can be opened in the *Main Menu* of the added TempScan temperature module via the following button with the corresponding group name:

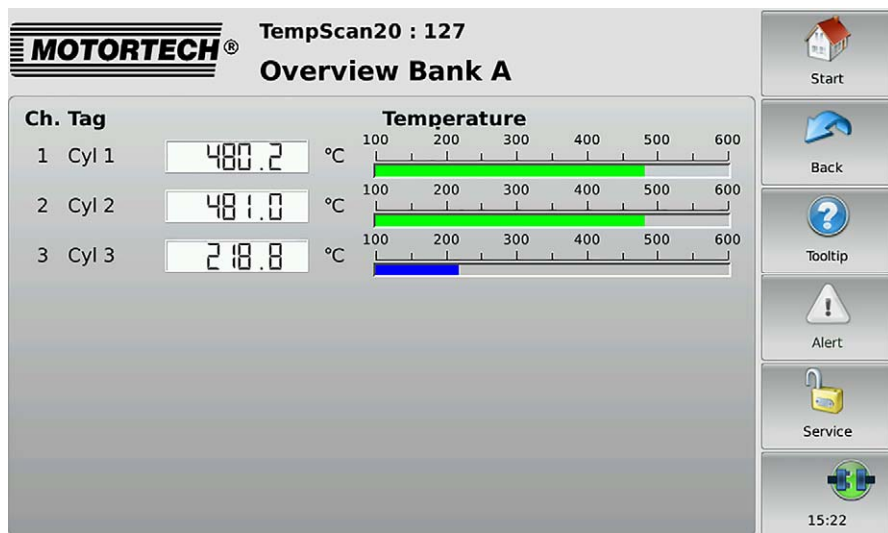

This view lists the measured temperatures of all channels in a group.

- *Ch.*: channel number
- *Tag*: user-specified abbreviation
- Currently measured *Temperature* (A = thermocouple failed; --- = channel not activated)

The colors of the temperature displays have the following meaning:

- Green: The temperature is within the permitted range.
- Blue: The temperature has dropped below the lower warning threshold.
- Yellow: The upper warning threshold has been exceeded.
- Red: The upper shutdown threshold has been exceeded.

Information about setting thresholds can be found in section *Thresholds* on page 122.

## 9.3.4.2 Temperatures

The group-specific view *Temperatures* is opened in the *Main Menu* of the added TempScan temperature module using the following button with the corresponding group name (here: *Bank A*):

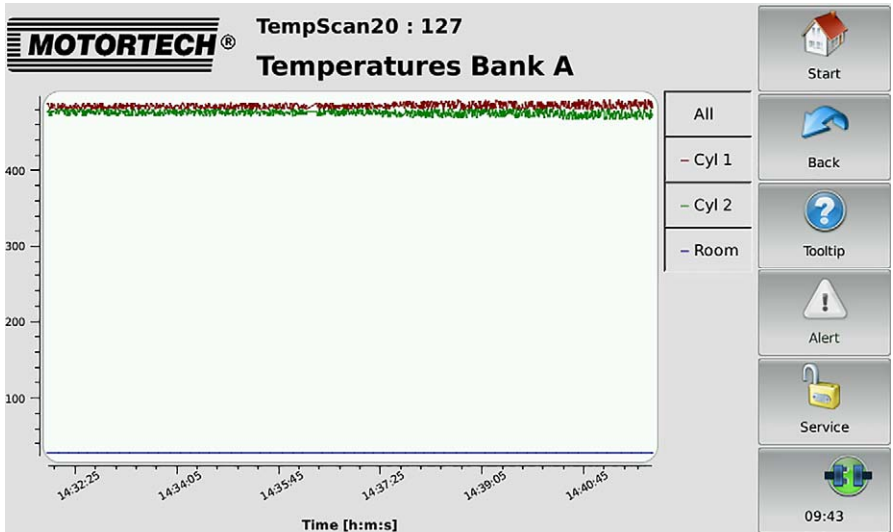

This view displays the temperature trends of all channels in a group. The available channels can be displayed or hidden via the legend.

## 9 Devices

### 9.3.4.3 Average Deviation

The group-specific view *Average Deviation* is opened in the *Main Menu* of the added TempScan temperature module using the following button with the corresponding group name (here: *Bank A*):



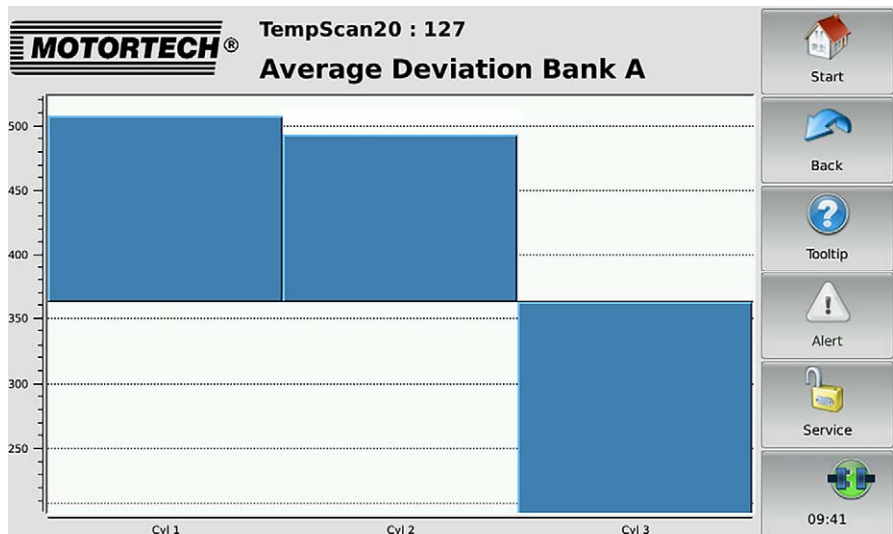

This button is only displayed if the checkbox *Average* in the *Group Names* view is activated (see *Groups* on page 116).



The deviation of each channel from the average temperature of all channels in a group is displayed.



## 10.1 Possible Faults

Fault	Possible cause	Solution
 <p>The databank symbol in the menu bar is red.</p>	<p>There is insufficient space on the USB flash drive or SD card.</p> <p>The USB flash drive or SD card cannot be read.</p>	<p>Use a storage device with sufficient disk space.</p> <p>Use a suitable storage device (see section <i>Interfaces</i> on page 24).</p>
 <p>The connection status symbol in the menu bar is yellow.</p>	<p>To at least one device there is no connection.</p> <p>The node ID of at least one added device is incorrect.</p>	<p>Establish the connection to the relevant devices (see section <i>CAN Bus Wiring</i> on page 35).</p> <p>Set the correct node ID for the relevant devices (see section <i>Devices</i> on page 51).</p>
 <p>The connection status symbol in the menu bar is red.</p>	<p>No other device is connected.</p>	<p>Check the CAN bus wiring (see section <i>CAN Bus Wiring</i> on page 35).</p>
<p>The display does not register touches at the desired position.</p>	<p>The display is dirty.</p> <p>The display is not calibrated properly.</p>	<p>Clean the display (see section <i>Cleaning the Touchscreen</i> on page 134).</p> <p>Perform a display calibration (see section <i>Display</i> on page 57).</p>
<p>The displays on the screen are difficult to recognize.</p>	<p>The lighting conditions are unfavorable.</p>	<p>Adjust the display to the lighting conditions using the <i>Day Mode/Night Mode</i> button in the <i>Start Menu</i>.</p>
<p>The system time is repeatedly incorrect.</p>	<p>The internal battery is dead.</p>	<p>Change the battery (see section <i>Changing the Battery</i> on page 132).</p>
<p>A connected device is indicating erroneous operating data.</p>	<p>Node IDs in the CAN bus are incorrectly assigned.</p> <p>The connected device is incorrectly wired.</p> <p>The connected device is incorrectly configured.</p>	<p>Check the node IDs of all remote devices on the CAN bus (see section <i>CAN Bus Wiring</i> on page 35).</p> <p>Check the wiring of the connected device.</p> <p>Check the configuration of the connected device.</p>

## 10 Errors

Fault	Possible cause	Solution
Data is not getting updated.	<p>The wiring of the CAN bus is defective.</p> <p>The remote device is not sending any data (for example if it is defective or the software has crashed).</p>	<p>Check the CAN bus wiring (see section <i>CAN Bus Wiring</i> on page 35) and correct any defects found.</p> <p>Check the connected device and fix the problems.</p>
The binary outputs are not switching.	<p>The binary outputs are not activated.</p> <p>The binary outputs are incorrectly wired.</p>	<p>Activate the binary outputs (see section <i>Devices</i> on page 51).</p> <p>Check the wiring of the binary outputs (see section <i>Binary Inputs/Outputs</i> on page 42).</p>
 <p>The symbol appears in the <i>Add Device</i> dialog next to devices.</p>	The device type has not been activated.	Activate the device type with an activation code (see section <i>Device Type Activation</i> on page 52).
<p>When tapping on a device in the <i>Start Menu</i>, you get one of the following error messages:</p> <ul style="list-style-type: none"> <li>– "The hardware ID of the connected device is invalid."</li> <li>– "Vendor ID or product code not valid."</li> </ul>	<p>The wiring of the CAN bus is defective.</p> <p>The bit rate of the connected device does not correspond to the bit rate of the PowerView3.</p> <p>In the PowerView3, the connected device has been assigned the wrong node ID.</p>	<p>Check the CAN bus wiring (see section <i>CAN Bus Wiring</i> on page 35) and correct any defects found.</p> <p>Change the bit rate of the connected device (see section <i>Connection</i> on page 60).</p> <p>In the PowerView3, set the correct node ID for the connected device (see section <i>Devices</i> on page 51).</p>

### 10.2 Customer Service Information

You can reach our customer service during business hours at the following phone and fax number, or by email:

Phone: +49 5141 93 99 0  
Fax: +49 5141 93 99 99  
Email: [service@motortech.de](mailto:service@motortech.de)

### 10.3 Returning Equipment for Repair / Inspection

To return the device for repair and inspection, obtain a return form and return number from MOTORTECH.

Fill out the return form completely. The completely filled out return form guarantees fast, uncomplicated processing of your repair order.

Send the device and the return form to one of the two addresses below or to the nearest MOTORTECH representative:

#### MOTORTECH GmbH

Hogrevestr. 21-23  
29223 Celle

Germany

Phone: +49 5141 93 99 0  
Fax: +49 5141 93 99 98

[www.motortech.de](http://www.motortech.de)  
[motortech@motortech.de](mailto:motortech@motortech.de)

#### MOTORTECH Americas, LLC

1400 Dealers Avenue, Suite A  
New Orleans, LA 70123

USA

Phone: +1 504 355 4212  
Fax: +1 504 355 4217

[www.motortechamericas.com](http://www.motortechamericas.com)  
[info@motortechamericas.com](mailto:info@motortechamericas.com)

### 10.4 Instructions for Packaging the Equipment

For return shipment, equipment should be packaged as follows:

- Use packaging material that does not damage the equipment surfaces.
- Wrap the equipment with sturdy materials and stabilize it inside the packaging.
- Use sturdy adhesive film to seal the packaging.

## 11 Maintenance

### 11.1 Changing the Battery

The internal board has a battery of the type CR2032, whose service life is ten years.



#### **Risk of injury!**

The PowerView3 is an electrically operated device. Disconnect the PowerView3 from all power supplies before changing the battery.



#### **Explosion hazard!**

Only use lithium batteries of type CR2032. Using the wrong battery can cause an explosion.



#### **Risk of destruction or injury**

Batteries must only be changed by authorized and trained personnel and following the operating manual. Improperly changing the battery can lead to destruction of the device or to injuries.



#### **Disposal of batteries**

Dispose of empty batteries in an environmentally responsible manner and complying with local regulations.

Change the battery as follows:

1. Shut down the device as described in the section *Shutdown* on page 28.
  - ▶ All connections including the power supply and, if applicable, the SD card and USB flash drive have been removed from the PowerView3.
2. Dismount the device from the control cabinet with a second person (see section *Installation* on page 33).
3. Put the PowerView3 on an even, soft surface.
4. Unscrew the four screws that attach the back cover panel.
5. Carefully remove the back cover panel.



### Risk of destruction!

The circuit board and the components mounted on it can be damaged by touch, contact with foreign bodies and contamination. It is therefore important that you carry out the following steps with the utmost care.

6. Remove the battery.

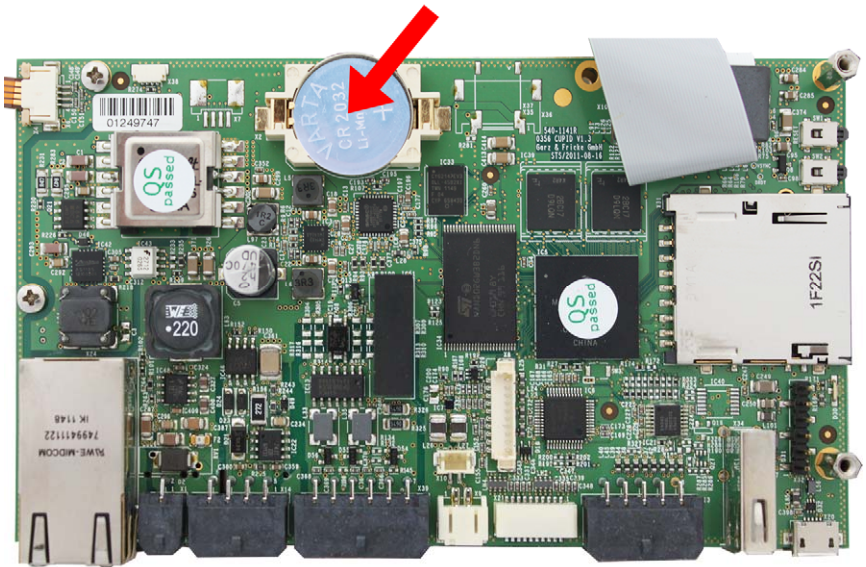

7. Insert the new lithium battery of type CR2032. The positive pole of the battery must be pointing upwards!
8. Close and screw shut the housing.
  - ▶ You can now reinstall and restart the device (see sections *Installation* on page 33 and *Start-up* on page 28).
9. Note that due to the battery change, the time and date settings of the PowerView3 are no longer accurate. After start-up, adjust the time and date (see section *Display* on page 57).

## 11 Maintenance

### 11.2 Cleaning the Touchscreen

Clean the touchscreen of the PowerView3 with a soft cotton cloth and alcohol.



#### **Risk of destruction!**

Dirt affects the function of the touchscreen. Water, fingerprints and other dirt should be removed immediately from the touchscreen and frame to avoid spots.



#### **Risk of destruction!**

Organic solvents as well as acids and alkaline solutions could damage the touchscreen. Therefore only clean the device with a soft cotton cloth and alcohol.

## A

Access control	
Changing the PIN .....	70
Enabling and disabling .....	66
Forgotten PIN .....	70
Logging in and logging out .....	68
Minimum level .....	68
Activation code (.ssk) .....	52
Alarm .....	47
Application .....	14

## B

Binary outputs	
Adjustments DetCon .....	108
Adjustments TempScan .....	117, 121
Enabling and disabling .....	51
Wiring .....	42
Bit rate .....	60
Board support package .....	57

## C

Calibration .....	57
CAN bus	
Setting .....	60
Wiring .....	35
Changing the battery .....	132
Cleaning .....	134
Communication setup .....	60
Communication status .....	47
Configuration .....	51

## D

Data	
Displaying recordings .....	63
Recorded files .....	62
Recording .....	55
Date .....	57
Day mode .....	49
Declaration of conformity .....	15
DetCon	
Adjustments .....	108
Analog output signal .....	105
Binary outputs .....	108
Knocking intensity .....	104, 105
Main menu .....	101
Overview .....	102
Trends .....	105

## Device

Cleaning .....	134
Configuration .....	51
Dimensions .....	20
Display .....	57
Display ID .....	57
Disposal .....	13
Electrical data .....	23
Installation .....	33
Interfaces .....	24
Mechanical data .....	20
Night mode/Day mode .....	49
Operation .....	45
Protection class .....	20
Restart .....	57
Return .....	131
Serial number .....	57
Shutdown .....	28
Start-up .....	28
Updating .....	29

## Device setup

Activating a device type .....	52
Activation code (.ssk) .....	52
Adding a device .....	53
Binary outputs .....	51
Deleting a device .....	55
DetCon .....	101
Editing .....	55
MIC ignition controllers .....	74
Other devices (Generic) .....	56
TempScan .....	110

Dimensions .....	20
Return .....	131

## Display

Calibration .....	57
Configuration .....	57
Display ID .....	57
Language .....	57
Night mode/Day mode .....	49
Display information .....	57
Disposal .....	13

## E

Errors .....	129
Event log .....	72

## G

Generic .....	56
---------------	----

## H

Help .....	47, 73
------------	--------

## 12 Index

<b>I</b>	
Ignition controllers	
Adjustments .....	85
Cylinder individual timing.....	85
Diagnosis .....	98
Energy .....	82, 85
Firing angles .....	82, 85, 93
Ignition.....	79
Ignition timing .....	78
Information.....	99
Main menu.....	74
Message log .....	96
Misfires .....	79
Operating hours.....	85
Overview .....	76
Reset position.....	85
Secondary voltage.....	93
Self test.....	85
States.....	96
Trends .....	93
Voltage calibration .....	85
Installation .....	33
Interfaces .....	24
<b>L</b>	
Language.....	57
Locking .....	65
<b>M</b>	
Maintenance	
Changing the battery .....	132
Cleaning .....	134
Menu bar .....	47
Minimum level .....	68
MOTORTECH	
Address .....	131
<b>N</b>	
Night mode.....	49
Node ID	
Added devices .....	51
PowerView3 .....	60
<b>O</b>	
Operation .....	45
Other devices.....	56
<b>P</b>	
PIN	
Changing .....	70
Forgotten .....	70
Pop-ups .....	57
Power supply .....	43
Protection class .....	20
<b>R</b>	
Recordings	
Recorded files .....	62
Recording .....	55
Regulations.....	15
Repair.....	131
Restart.....	57
Return shipment.....	131
<b>S</b>	
Safety instructions .....	10
Scope of supply.....	32
Screen saver.....	57
Serial number .....	57
Service .....	131
Shutdown .....	28
Software	
Activating a device type .....	52
Software version .....	57
Updating.....	29
Start menu.....	49
Start-up .....	28
<b>T</b>	
Temperature units .....	57
TempScan	
Adjustments.....	113
Channel activation.....	117, 121
Channel names .....	114, 117
Channel settings .....	117
Group names.....	116
Main menu.....	110
Overview.....	112
Reference junction.....	124
Saving .....	113
Status.....	124
Thermocouples .....	117, 120
Thresholds.....	117, 122
Time .....	57
Tooltip.....	47
<b>U</b>	
Unlocking .....	65
<b>W</b>	
Weight.....	20
Wiring	
Binary inputs/outputs .....	42
CAN bus.....	35







● **MOTORTECH GmbH**  
Hogrevestr. 21-23  
29223 Celle  
Germany  
Phone: +49 (5141) 93 99 0  
Fax: +49 (5141) 93 99 99  
[www.motortech.de](http://www.motortech.de)  
[sales@motortech.de](mailto:sales@motortech.de)

● **MOTORTECH Americas, LLC**  
1400 Dealers Avenue, Suite A  
New Orleans, LA 70123  
USA  
Phone: +1 (504) 355 4212  
Fax: +1 (504) 355 4217  
[www.motortechamericas.com](http://www.motortechamericas.com)  
[info@motortechamericas.com](mailto:info@motortechamericas.com)

● **MOTORTECH Shanghai Co. Ltd.**  
Room 1018 Enterprise Square,  
No. 228 Meiyuan Road,  
Zhabei District  
200070 Shanghai, China  
Phone: +86 (21) 6380 7338  
[www.motortechshanghai.com](http://www.motortechshanghai.com)  
[info@motortechshanghai.com](mailto:info@motortechshanghai.com)